

MILAN

Assembly Instructions



Care & Instruction Manual

Please read and retain these instructions for future reference

1/6

⚠ Safety and Care Advice

Important – Please read these instructions fully before starting assembly

Check you have all the components and tools listed.

Remove all fittings from the plastic bags and separate them into their groups.

Keep children and animals away from the work area, small parts could choke if swallowed.

Make sure you have enough space to layout the parts before starting.

Assemble the item as close to its final position (in the same room) as possible.

Do not fully tighten bolts until the chair is assembled.

Do not overtighten the nuts to avoid causing damage to the threads.



We do not recommend the use of power drill/drivers **for inserting screws**, as this could damage the unit.

Only use hand screwdrivers and Allen keys.

Only clean using a damp cloth and mild detergent, do not use bleach or abrasive cleaners.

From time to time check that there are no loose screws on this unit.

This product should not be discarded with household waste. Take to your local authority waste disposal centre.

2/6

Components - Parts

Please check you have all the parts listed below

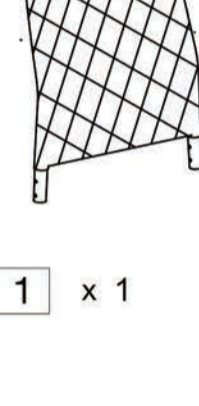

1 x 1



4 x 1

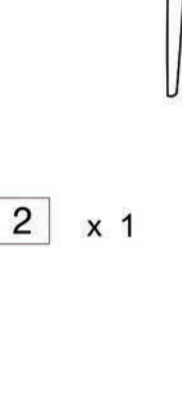

2 x 1

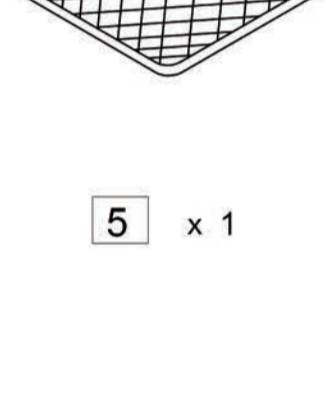

5 x 1







3 x 1

3/6

Components - Fittings

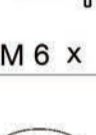
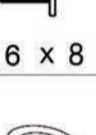
Please check you have all the fittings listed below

Note: The quantities below are the correct amount to complete the assembly. In some cases more fittings may be supplied than are required.

<p>A</p>  <p>M 6 x 2</p>	<p>B</p>  <p>M 6 x 8</p>	<p>C</p>  <p>M 4 x 1</p>
<p>D</p>  <p>M 6 x 10</p>	<p>E</p>  <p>M 6 x 10</p>	

Tools required



Ruler/tape measure

screw driver (not provided)



Ruler - Use this ruler to help correctly identify the screws



4/6

Assembly Instructions

Step 1

Assembling frame

Insert the chair back 1 into the right 3 and left leg 2.

Screw bar 4 into place with A, E and D. Use Allen key C to tighten.

⚠ Only tighten to 90% at all stages, accept the last.

Place the seat pad upside down on a flat raised surface ie. Kitchen top.

Place the chair over the seat pad and screw down into the seat pad to secure.

⚠ Only tighten to 90% at all stages, accept the last.

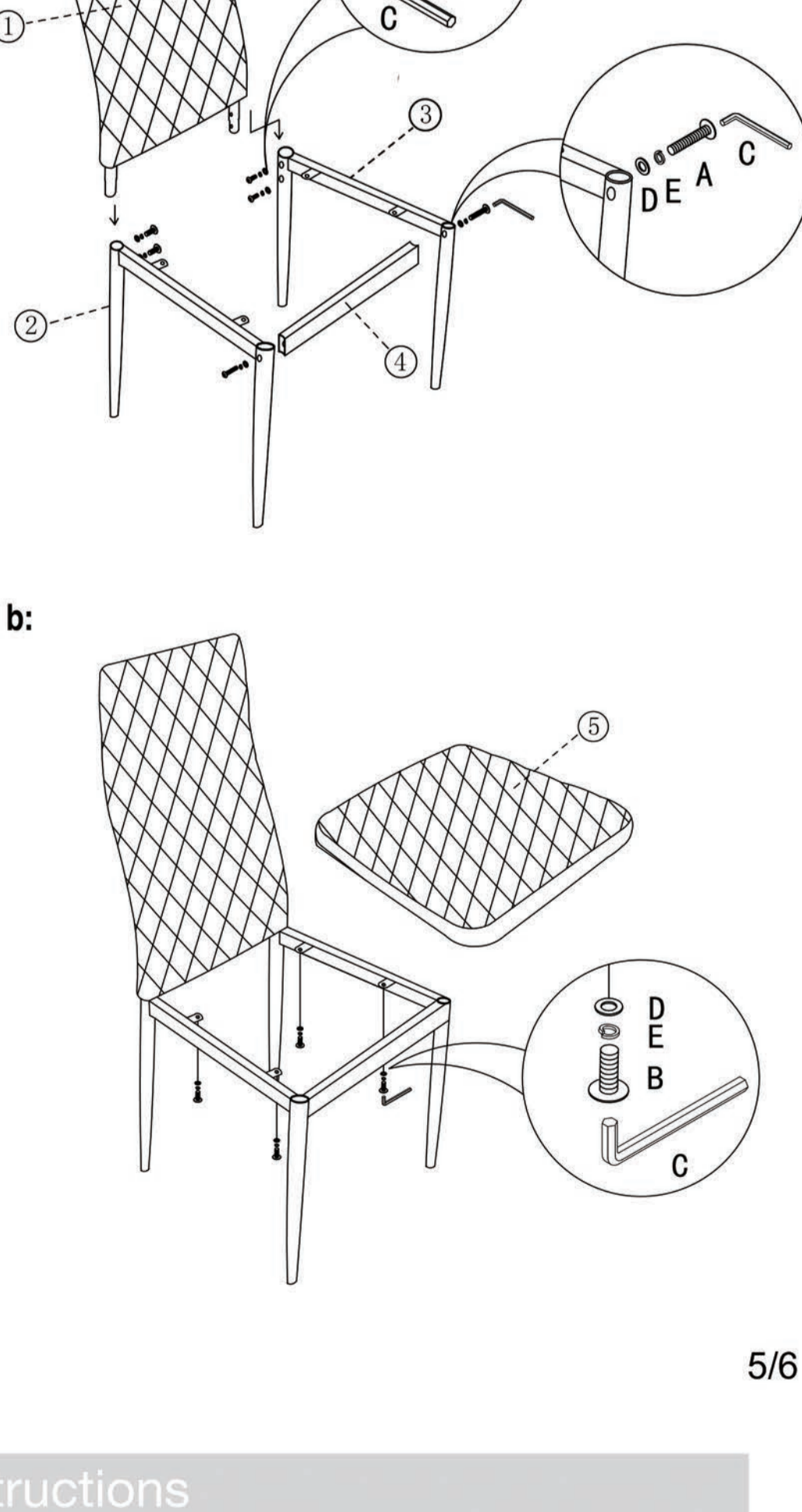

5/6

Assembly Instructions

Step 2

Assembling seat pad

Turn the chair upright. Either sit on or place a weight on the top of the chairs until all feet are level.

Proceed to tighten all bolts to finish assembly.

⚠ Get someone to sit on the chair to make all the feet level. It is best to fully tighten all bolts while someone is sitting on the chair to ensure there is no issue with uneven legs.

C:

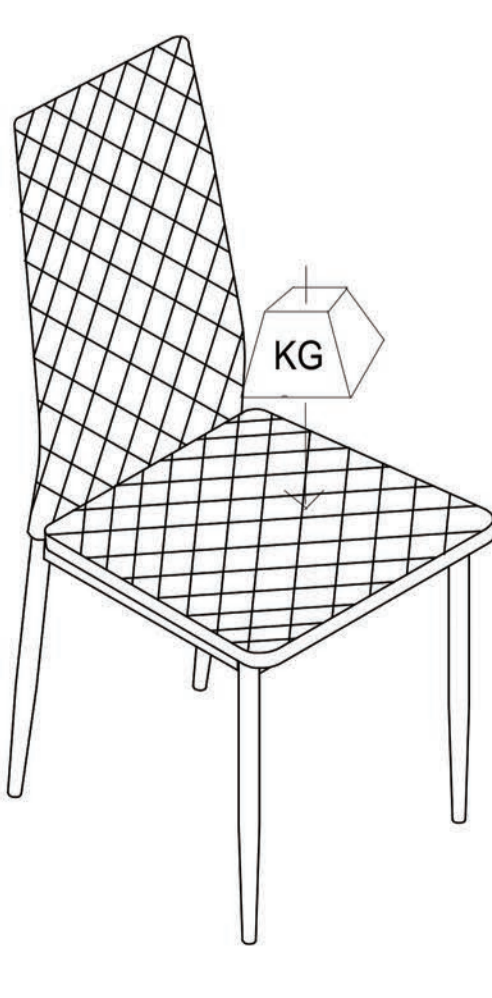

6/6