

ASSEMBLY INSTRUCTIONS
COASTER FINE FURNITURE

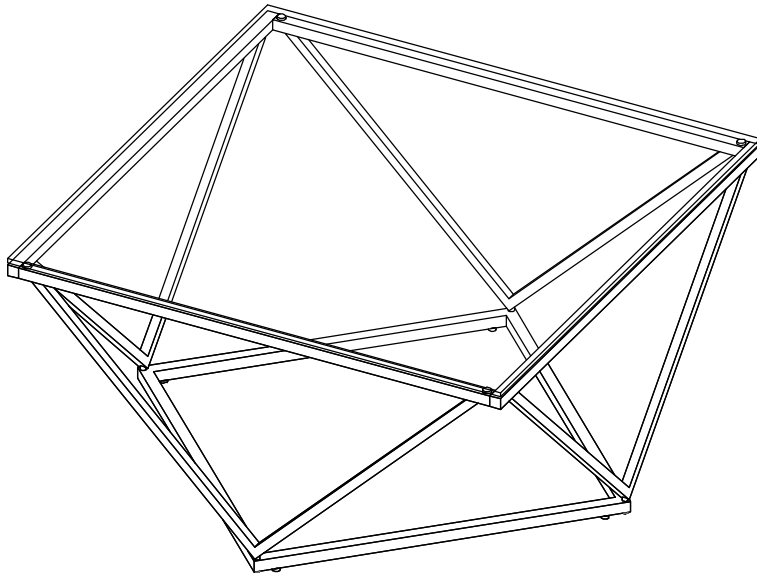

Fine Furniture for every stage of life

709738
COFFEE TABLE

REVISION 0 : 04/09/2024

PAGE 1 OF 5

COASTERFURNITURE.COM

ITEM:709738



ASSEMBLY INSTRUCTIONS

ASSEMBLY TIPS:

1. Remove hardware from box and sort by size.
2. Please check to see that all hardware and parts are present prior to start of assembly.
3. Please follow attached instructions in the same sequence as numbered to assure fast & easy assembly.



WARNING!

1. Don't attempt to repair or modify parts that are broken or defective. Please contact the store immediately.
2. This product is for home use only and not intended for commercial establishments.

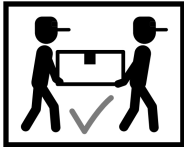

ASSEMBLY TIME 25 MINUTES

PARTS IDENTIFICATION

A GLASS 1PC

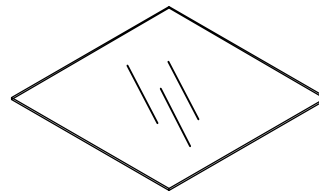

B SIDE FRAME A 2PCS

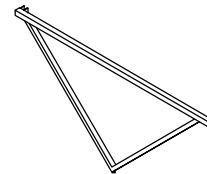

C SIDE FRAME B 2PCS

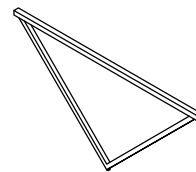

D BOTTOM FRAME 1PC

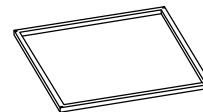

Z HARDWARE IDENTIFICATION

1 SHORT BOLT (1/4" x 12mm SR) 4PCS



4 LEVELER (1/4" x 12mm BLK) 4PCS



2 LONG BOLT (1/4" x 28mm SR) 4PCS



5 ALLEN WRENCH (4mm) 1PC



3 SUCTION CUP 4PCS



ITEM: 709738



ASSEMBLY INSTRUCTIONS

STEP 1 Do not tighten until each step is completed or instructed.

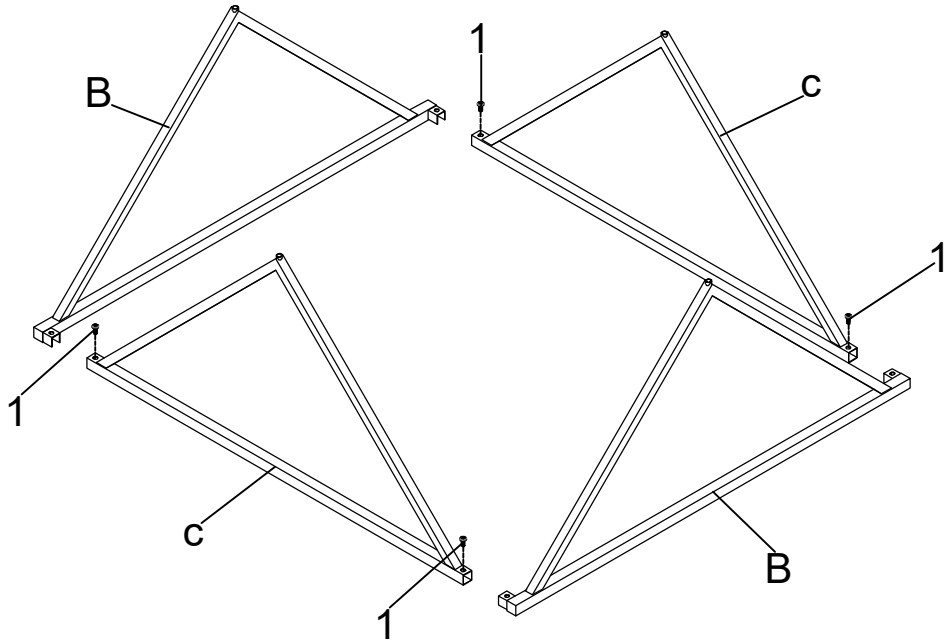

STEP 2

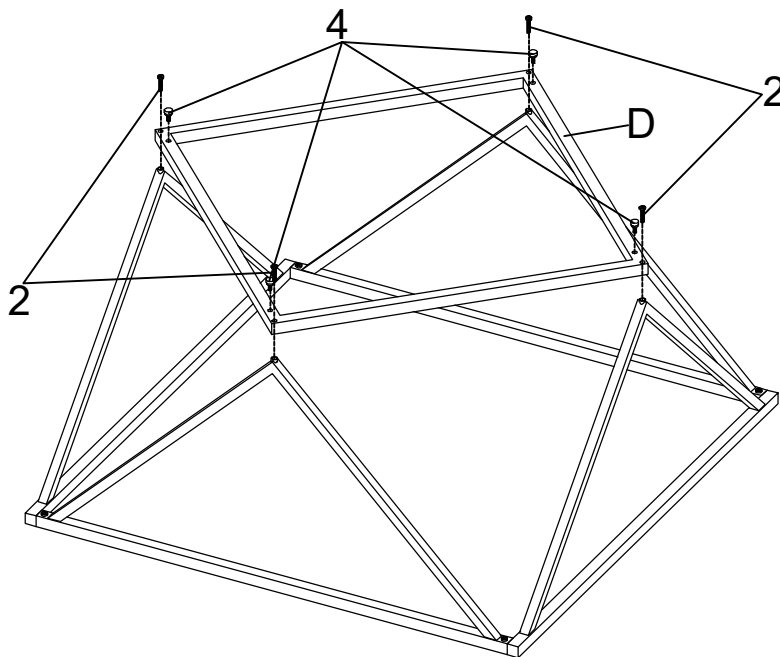

ITEM:709738

ASSEMBLY INSTRUCTIONS

STEP 3

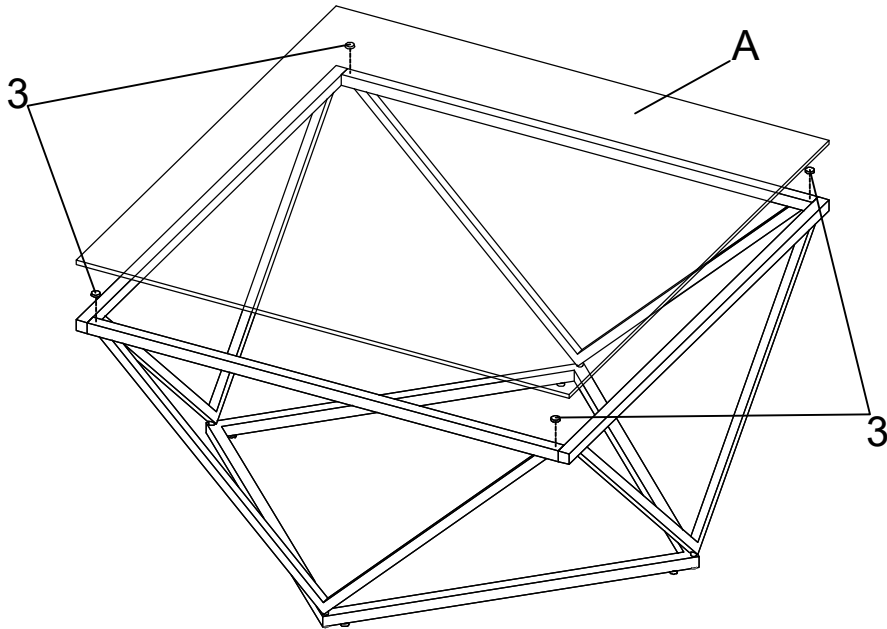

STEP 4 COMPLETE

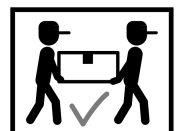
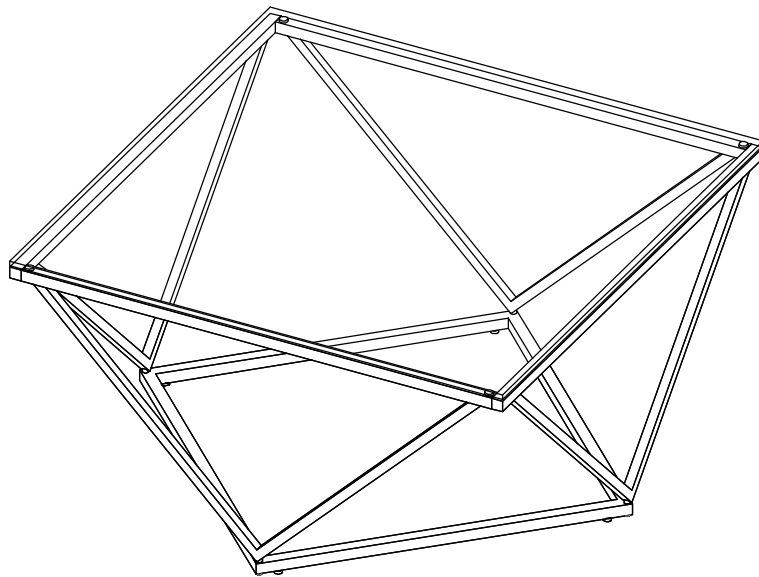

ITEM:709738

ASSEMBLY INSTRUCTIONS



Product Size : 908 X 908 X 457 H (MM)

Product Size : 35.75" X 35.75" X 18"

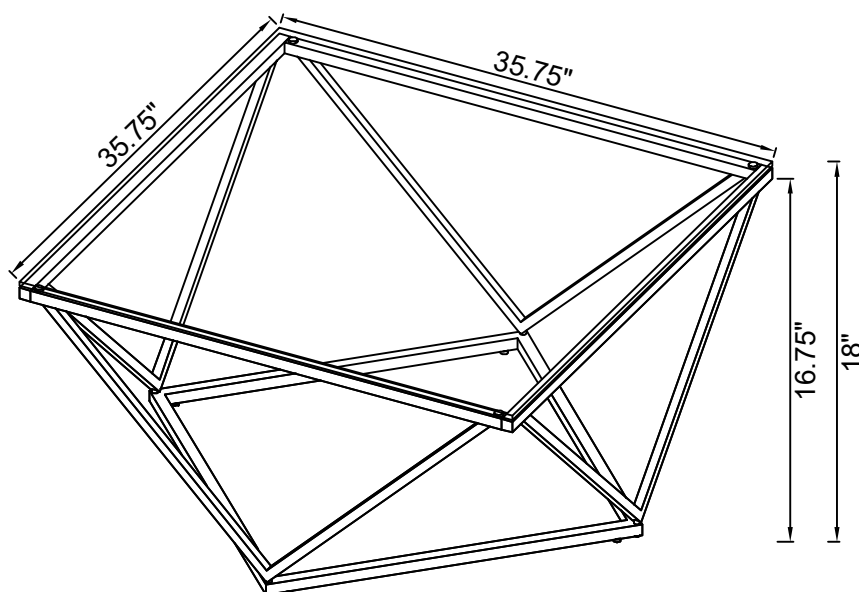

Note : Dimension tolerance $\pm 5\%$