

Bun Foot

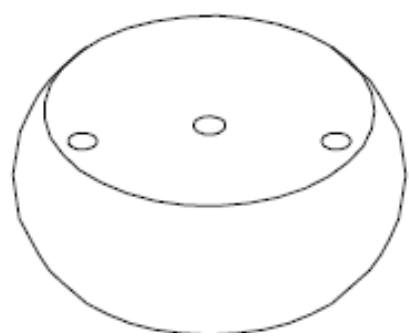



Congratulations! You have purchased a stylish piece of us. We strive to provide fine furniture products, built with quality materials and hand finished details. Please carefully follow the assembly instructions to ensure your furniture is assembled correctly to provide long lasting enjoyment.

Should you experience any missing or damaged parts, **do not return to the store.** Please contact us directly.

Care: Use a soft clean cloth that will not scratch the surface when dusting. Use of furniture polish is not necessary. Should you choose to use polishes, test in an inconspicuous area first. Use of solvents of any kind may damage your furniture's finish. To clean, simply use a soft clean cloth moistened with lukewarm water, then buff with a dry soft clean cloth.

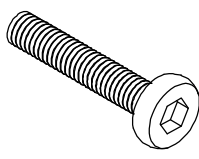
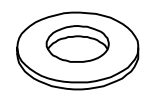
HARDWARE LIST

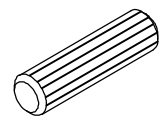
<div style="border: 1px solid black; padding: 2px; width: 20px; margin: 0 auto; text-align: center;">1</div> 	<div style="border: 1px solid black; padding: 2px; width: 20px; margin: 0 auto; text-align: center;">2</div> 	<div style="border: 1px solid black; padding: 2px; width: 20px; margin: 0 auto; text-align: center;">3</div> 	<div style="border: 1px solid black; padding: 2px; width: 20px; margin: 0 auto; text-align: center;">4</div> 
HEX SOCKET HEAD BOLT 4 PCS	FLAT WASHER 4 PCS	SPRING WASHER 4 PCS	WOOD DOWEL 8 PCS

PART LIST

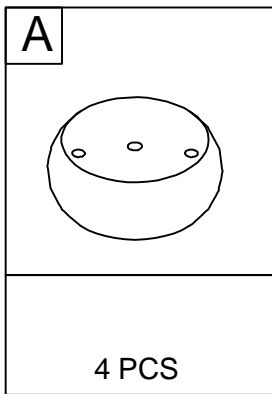

step 1. Insert Wood Dowel (4) into two pre-drilled side holes on Bun Foot A. Attach bun foot to cabinet bottom, insert Hex Socket Head Bolt (part#1) with Spring Washer (part#3) and Flat Washer (part#2) through Bun Foot A. Turn bolts clockwise with Allen Wrench until tight.

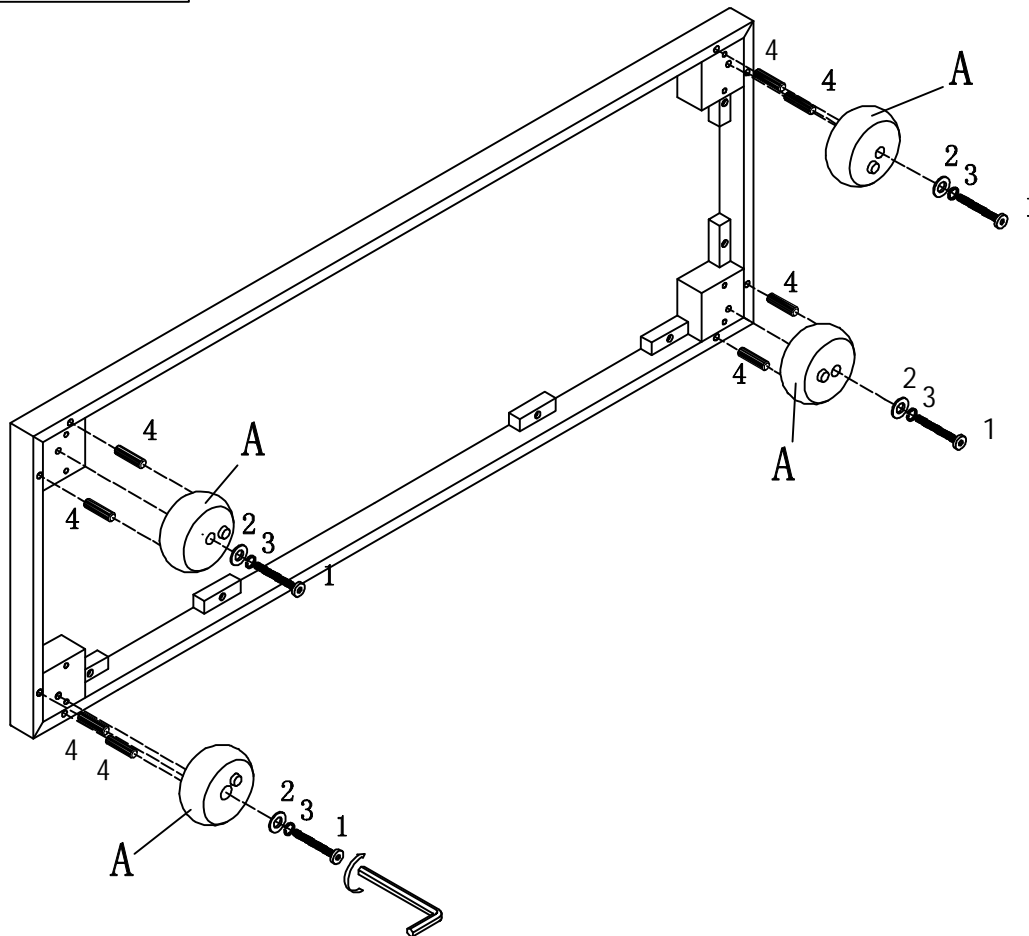

Limited Manufacturers Warranty

Our products are warranted against defects in material and workmanship for a period of 90 days beginning from the date of sale. Should any parts be missing or defective, we will replace or repair the parts for a period of 90 days from the date of purchase.

Should you experience any missing or damaged parts, do not return to the store.

Please contact us directly.

This warranty gives the purchaser specified legal rights in addition to any rights which may vary from state to state.

In accordance with the "Moss-Magnuson Warranty Act" of July 10, 1975, this is termed a "limited warranty" which in no way compromises Our high standards of Quality and Workmanship.