

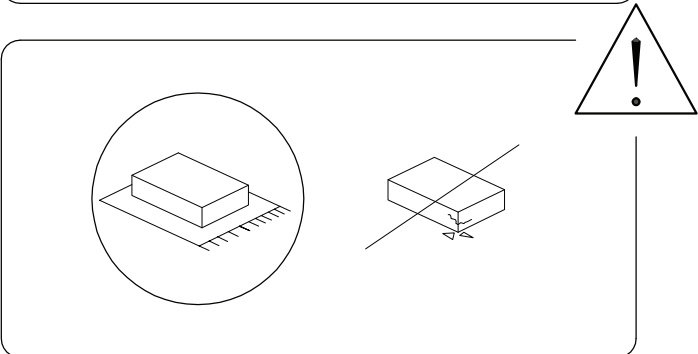

15'

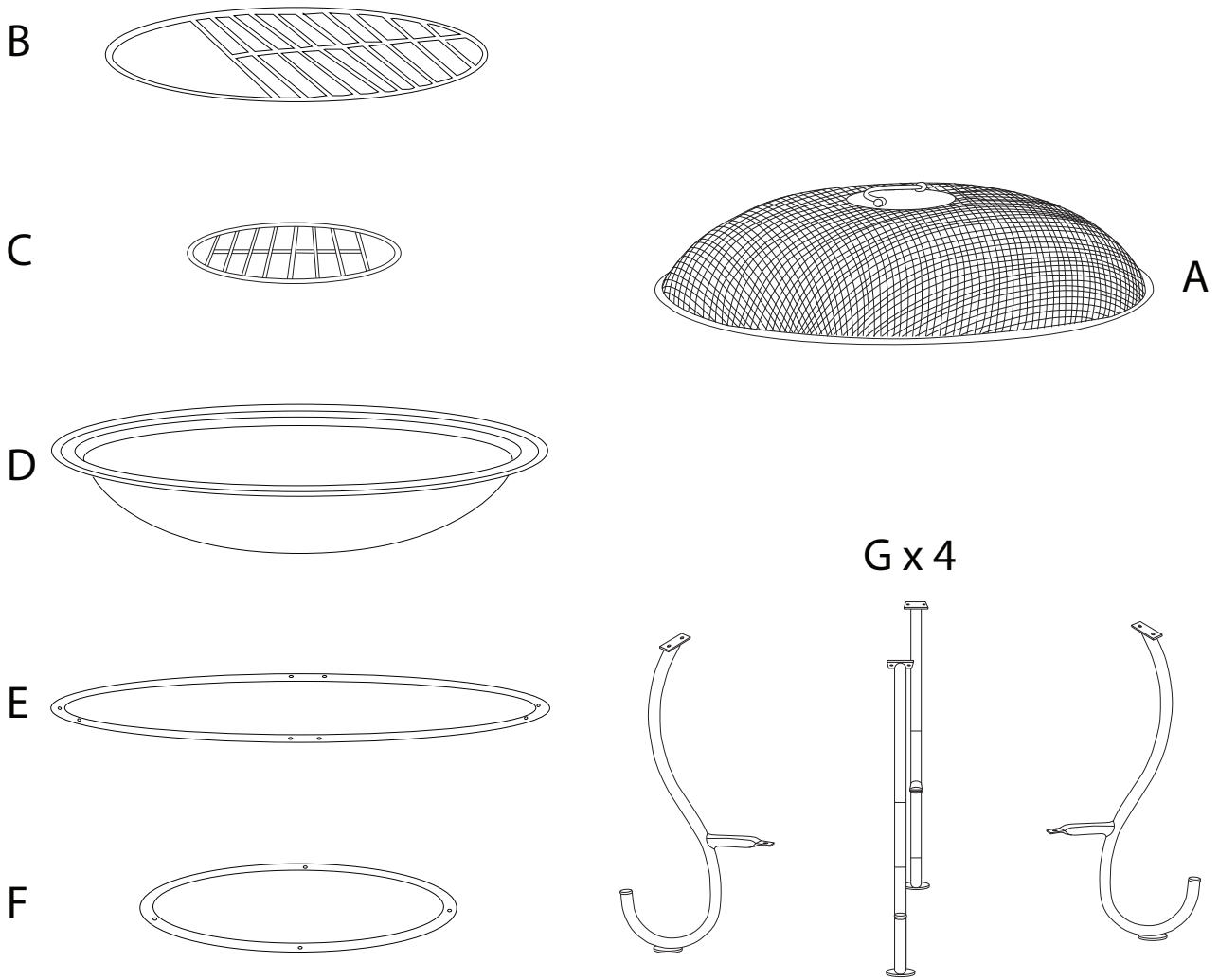

1

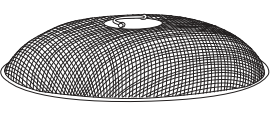
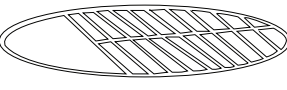
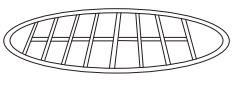

A	B	C	D
			
x 1	x 1	x 1	x 1

E

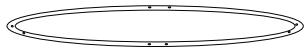

x 1

F

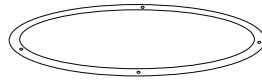

x 1

G



x 4

T1

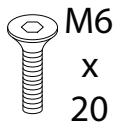

x 4

T2



x 8

U

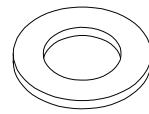

x 12

V

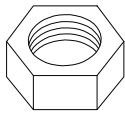

x 12

X

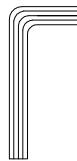

x 1

Y

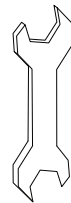





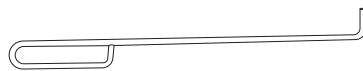

x 1

Z





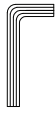

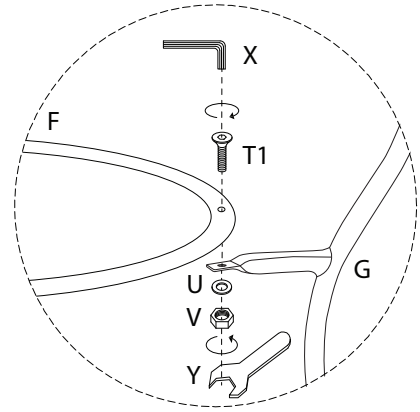
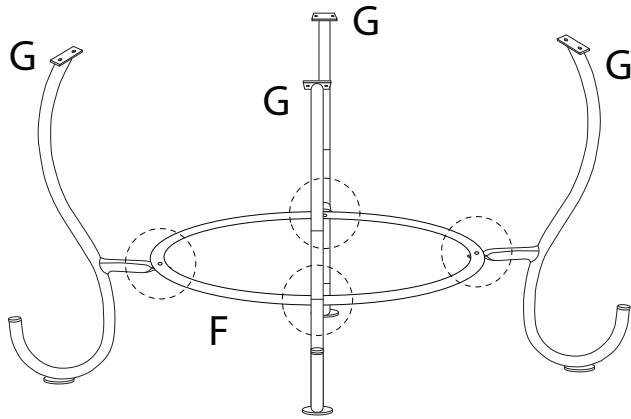

x 1

1

<b>G</b>  x4	<b>F</b>  x1	<b>T1</b>  x4	<b>U</b>  x4	<b>V</b>  x4	<b>X</b>  x1	<b>Y</b>  x1
---	---	--	---	--	---	---

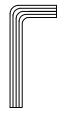

2

<b>E</b>  x1	<b>T2</b>  x8	<b>V</b>  x8	<b>U</b>  x8	<b>X</b>  x1	<b>Y</b>  x1
---	--	---	--	---	---

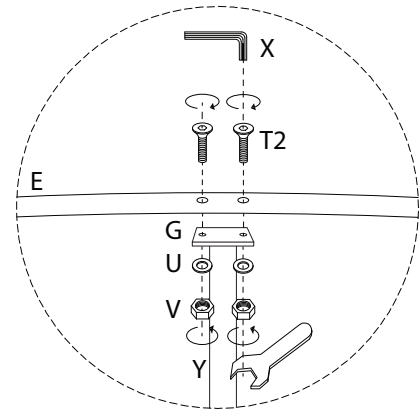
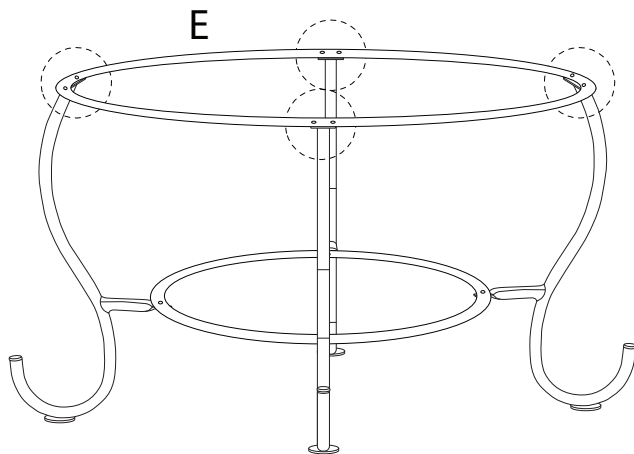

3

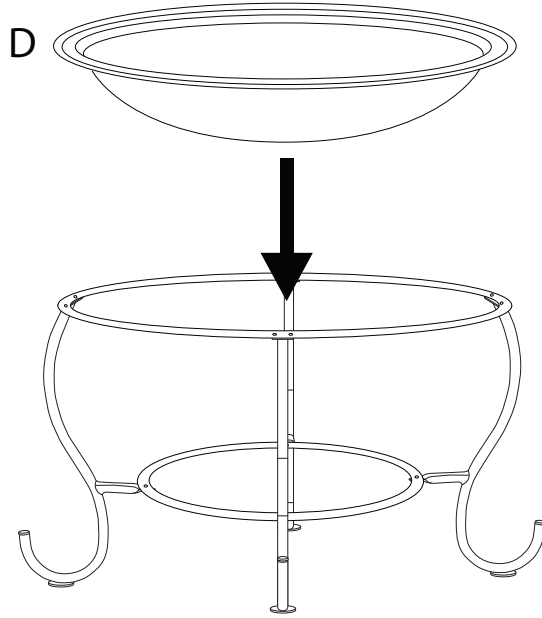
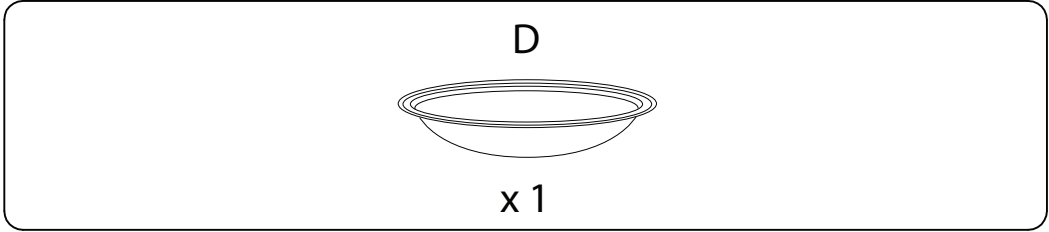

4

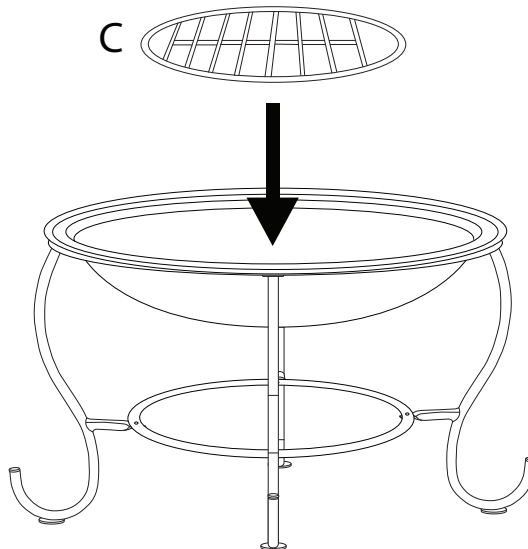
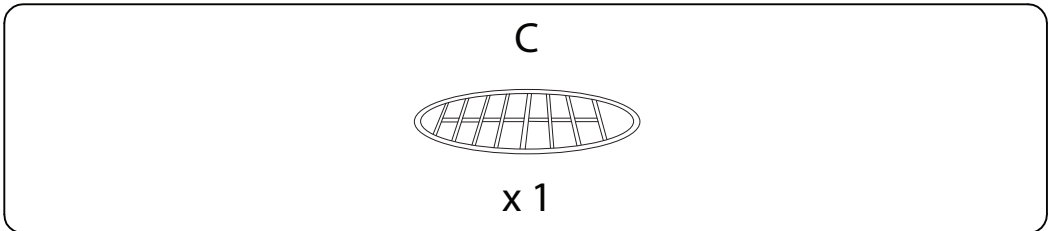

5

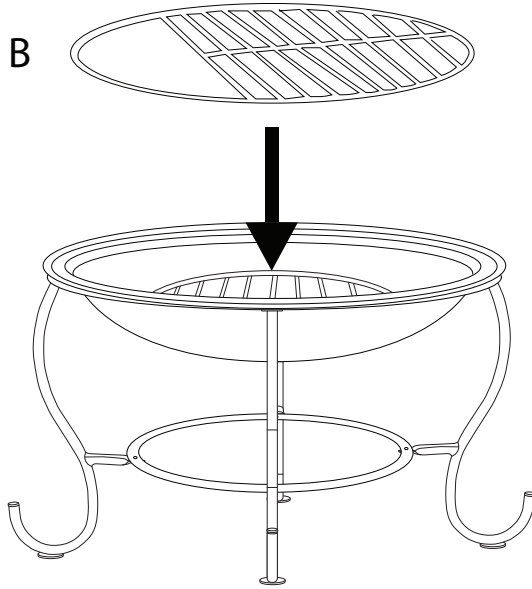
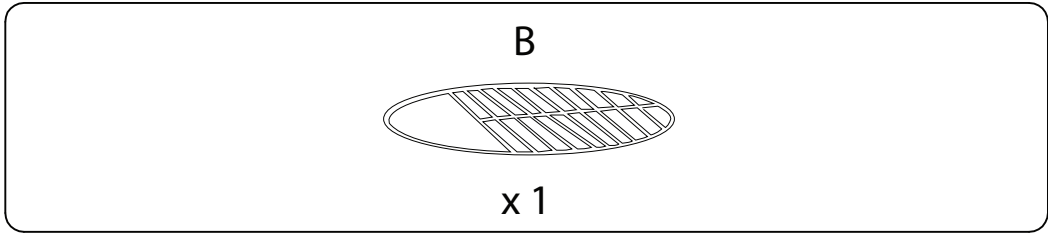

6

