

**ASSEMBLY TIPS:**

1. Remove hardware from box and sort by size.
2. Please check to see that all hardware and parts are present prior to start of assembly.
3. Please follow attached instructions in the same sequence as numbered to assure fast & easy assembly.



**Warning !**

1. Don't attempt to repair or modify parts that are broken or defective. Please contact the store immediately.
2. This product is for home use only and not intended for commercial establishment.







ASSEMBLY TIME	10 MINUTES
---------------	------------

**PARTS IDENTIFICATION**

<b>A</b>		CUSHION SEAT WITH FRAME	1 PC
<b>B</b>		LEG	4 PCS
<b>C</b>		BOTTOM FRAME	1 PC

**HARDWARE IDENTIFICATION**

<b>1</b>		ALLEN WRENCH	1 PC
<b>2</b>		BOLT	12 PCS
<b>3</b>		LOCK WASHER	12 PCS
<b>4</b>		FLAT WASHER	12 PCS

STEP 1

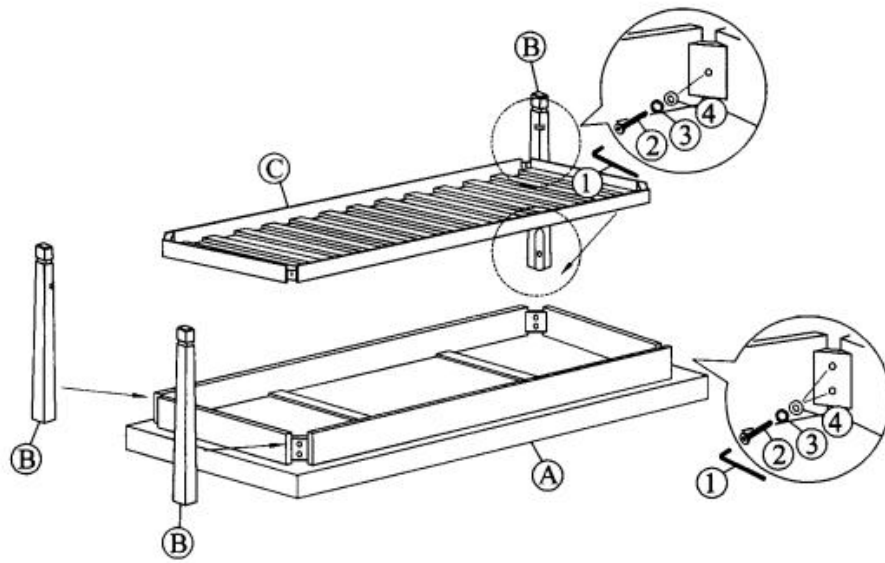

STEP 2

