

INSTRUCTION

Teslin Swing Dining Chair(2PCS)

Assembly & Care instructions



SKU: P25024-S1

Please read & retain for future reference

CATALOGS

Care & Instructions	3
Parts List	4
Screw Set List	5
Extra	6
Specifications	7
Installation Instructions	8

Care & Instructions







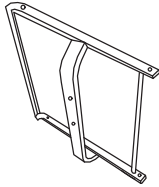
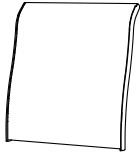
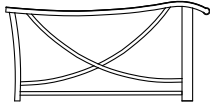
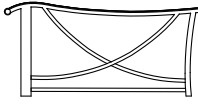
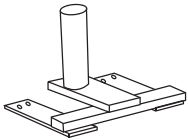
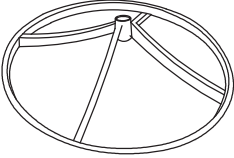

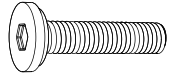
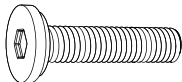
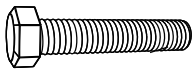
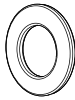

Thank you for ordering this teslin swing dining chair set. Here are some suggestions that may help you:

1. This set of outdoor teslin swing dining chair has two in a box.
2. If any parts are damaged or lost, please read this instruction carefully (refer to the parts list on page 4 through page 6), please feel free to contact us. We will send you a replacement immediately.
3. We hope you can like our products, if you have any other questions, please contact us.

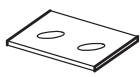



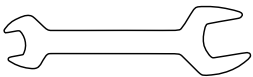

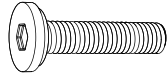
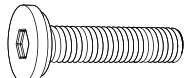
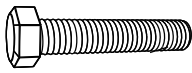
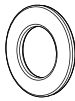

PARTS LIST

PARTS LIST			
Part	Description	Part Name	Qty
L001		Seat Plate Part	2
L002		Back Plate Part	2
L003		Left Armrest Part	2
L004		Right Armrest Part	2
L005		Connection Bar	2
L006		Bottom Turntable	2

SCREW SET LIST

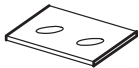
Screw Set List			
Part	Description	Part Name	Qty
A		Bolt M6 × 35	16PCS
B		Bolt M6 × 40	2PCS
C		Bolt M8 × 45	8PCS
D		M6 Gaskets	18PCS
E		M8 Gaskets	8PCS
F		M6 Bolt Cap	18PCS
G		M8 Bolt Cap	8PCS
H		M8 Spring Gasket	8PCS
I		Spring Tabs	4PCS
J		M8 Jam Nuts	8PCS
K		M8 Nut Cap	8PCS
L		M8 Metal Cover	2PCS
M		Wrench	2PC
N		Allen wrench M6	1PCS

EXTRA

Extra			
Part	Description	Part Name	Qty
A		Bolt M6 × 35	2PCS
B		Bolt M6 × 40	1PC
C		Bolt M8 × 45	1PC
D		M6 Gaskets	2PCS
E		M8 Gaskets	1PC
F		M6 Bolt Cap	2PCS
G		M8 Bolt Cap	1PC
H		M8 Spring Gasket	1PC
I		Spring Tabs	1PC
J		M8 Jam Nuts	1PC
K		M8 Nut Cap	1PC
L		M8 Metal Cover	1PC

WARNING: Failure to locate parts in accordance with these diagrams, or failure to use special parts provided with this equipment, may result in property damage or personal injury.

SPECIFICATIONS

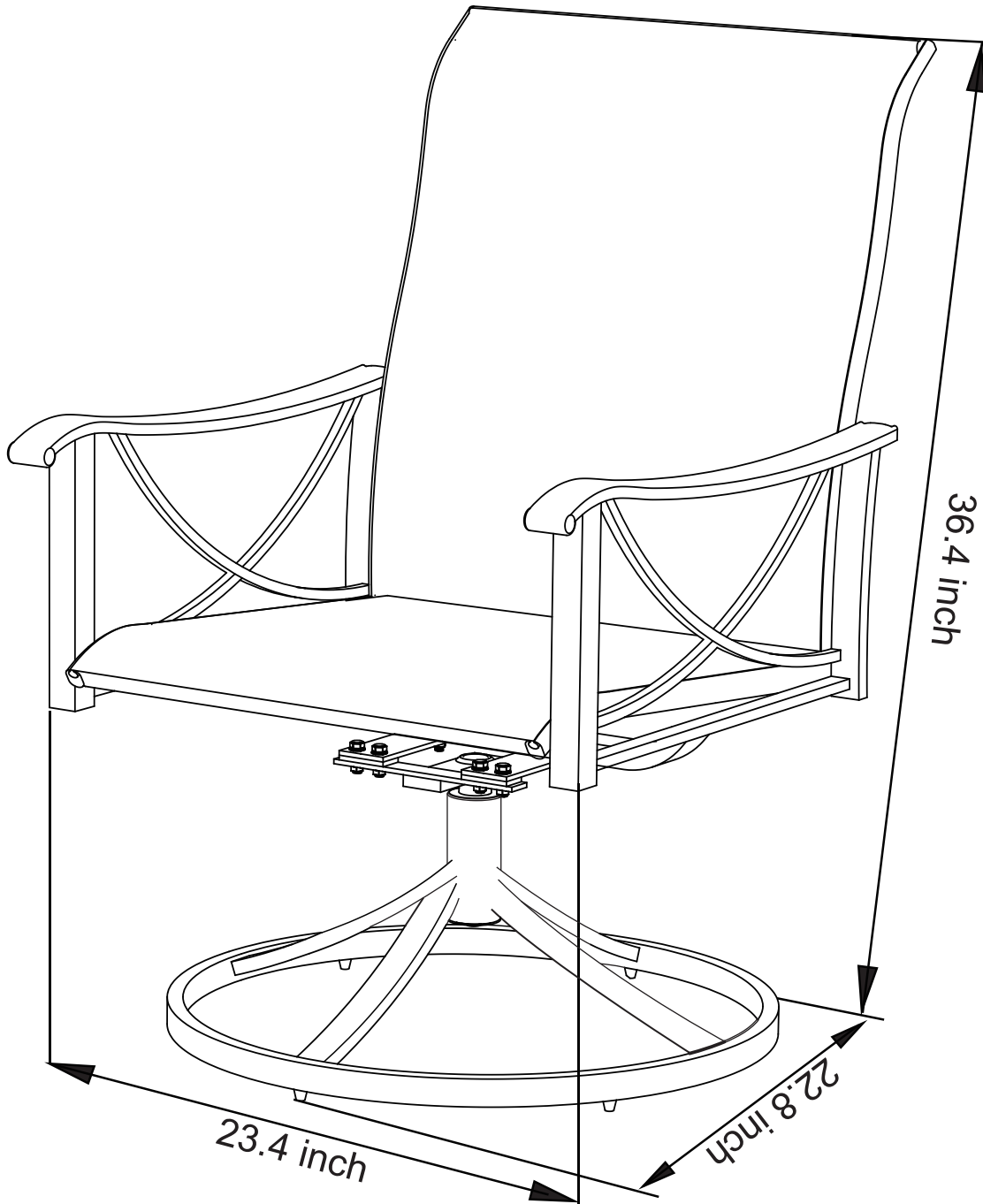

INSTALLATION STEPS

Step 1

Attach the dining chair seat plate(L001) and left armrest(L003) with screws(A).

Note: Do not tighten bolts.

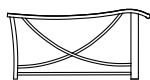
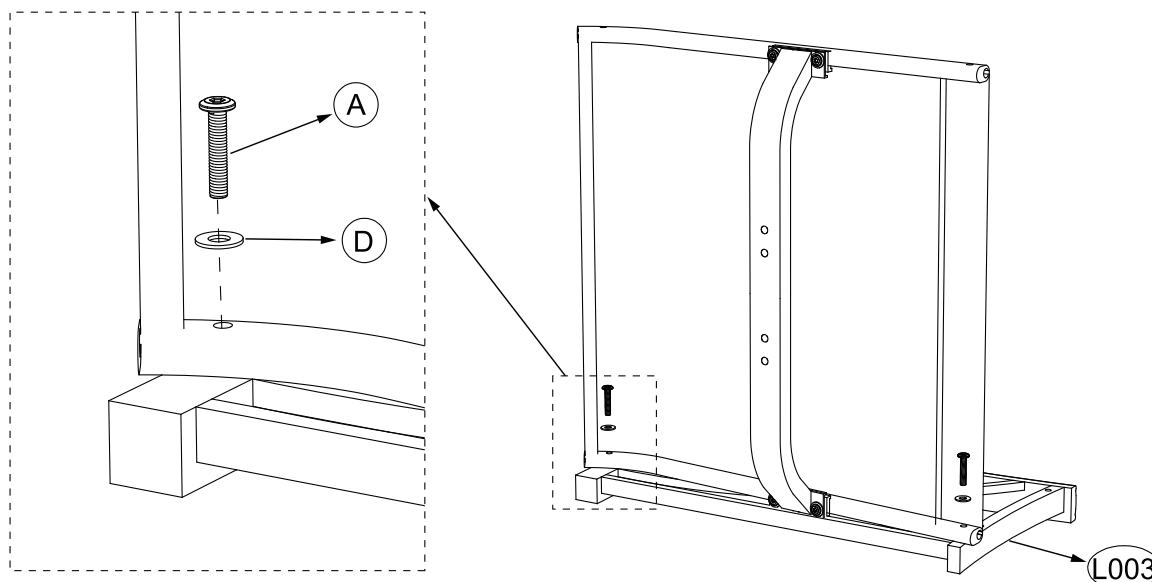

L003×2



L001×2

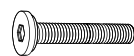

A×4



D×4



N

Step 2

Attach the dining chair seat plate(L001) and right armrest(L004) with screws(A).

Note: Do not tighten the Bolt.

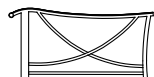
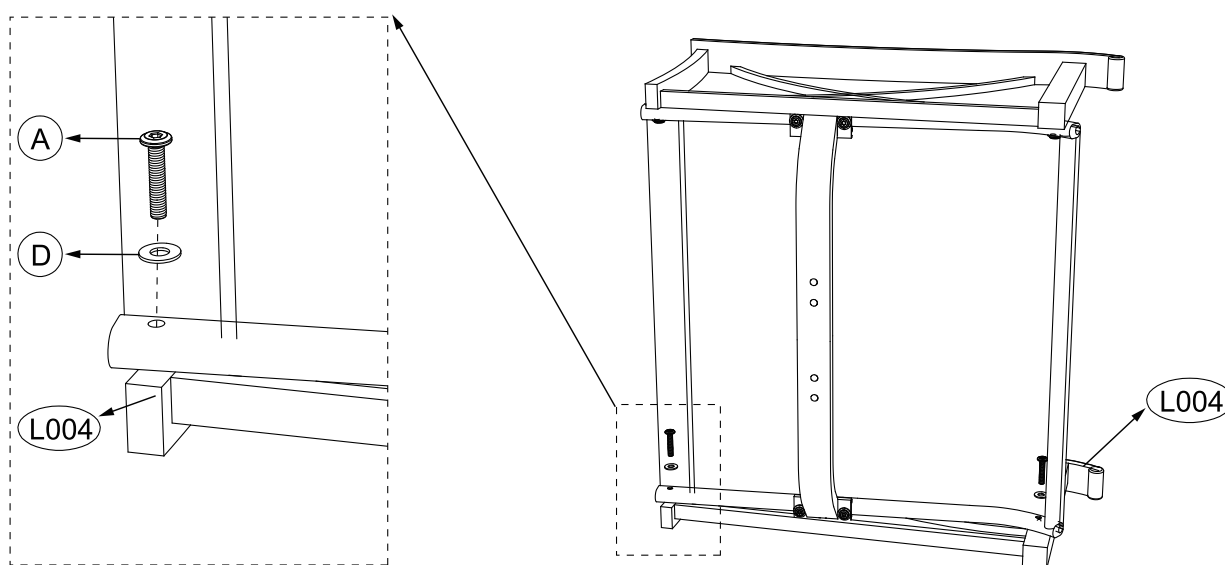

L004×2

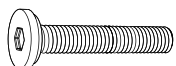

A×4



D×4



N

INSTALLATION STEPS

Step 3

Attach the dining chair backrest (L002) and the left and right armrests (L003 and L004) together with screws (A).
Note: Tighten bolts at this time.

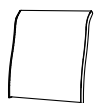
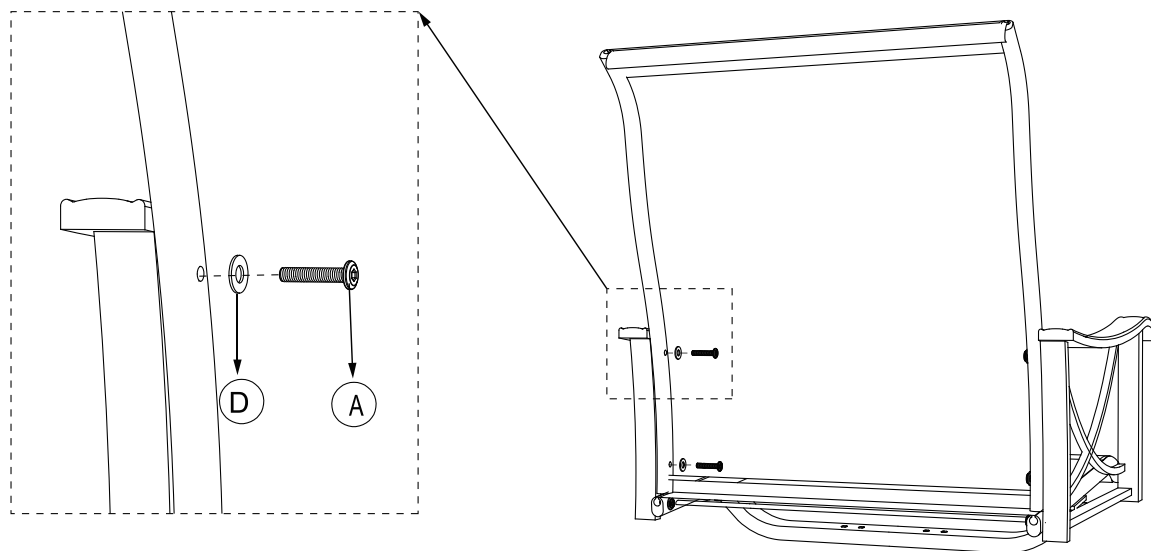

L002×2

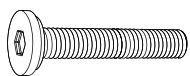

A×8



D×8



N

Step 4

Insert the Connection Bar (L005) into the Bottom Turntable (L006) and tighten the Bolt (B) through the M6 Large Gaskets (D) and lock it into the Connection Bar (L005) as shown.

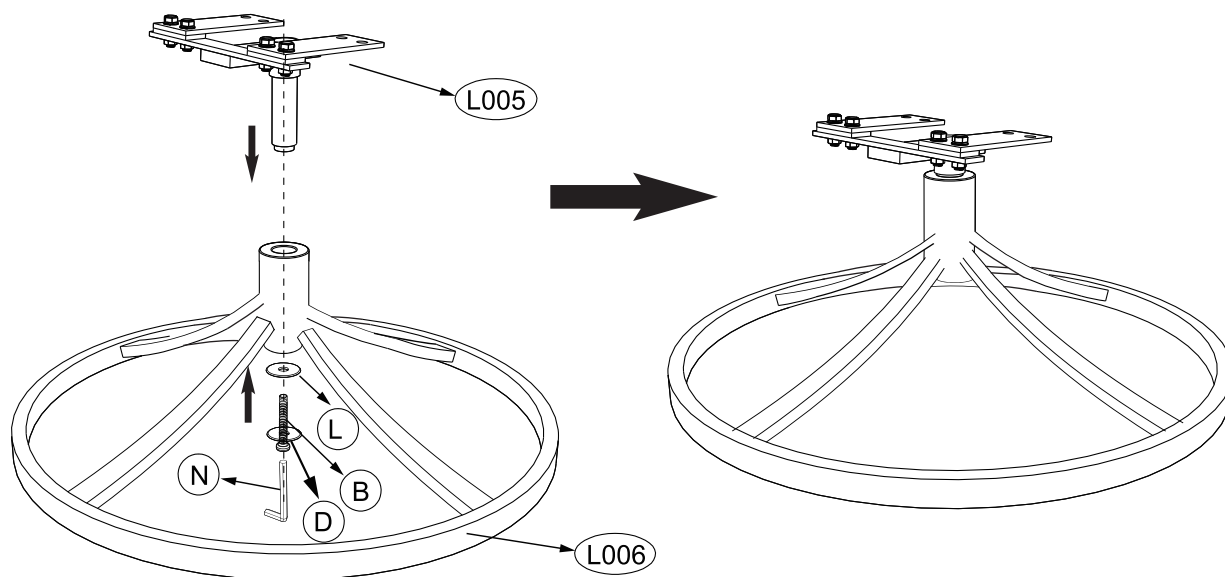

L006×2

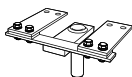

L005×2



L×2



B×2



D×2



N

INSTALLATION STEPS

Step 5

Combine the upper and lower parts, align the lower holes in (L001) with the holes in (L005), install the Spring Tabs (I), the Blot (C), the M8 Gaskets (E), the Spring Tabs (H), the Jam nuts (J) in the order of the way, and tighten the bolts and nuts with the Wrench (M) and allen wrench M6 (N).

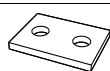
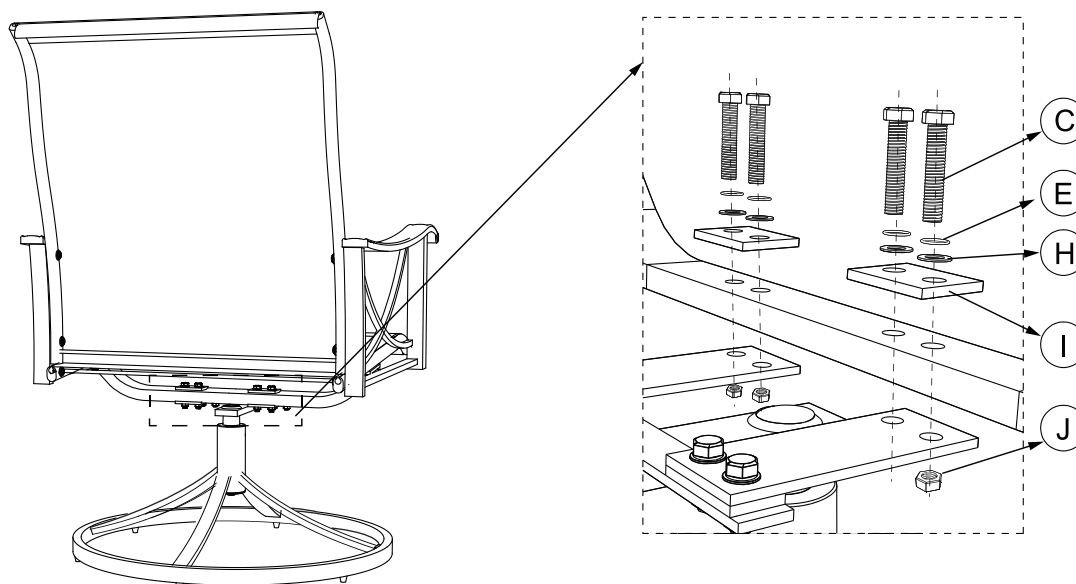

I×4



C×8



E×8



H×8



J×8

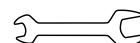

M

Step 6

Put all bolt caps (F, G and K) on the bolts.

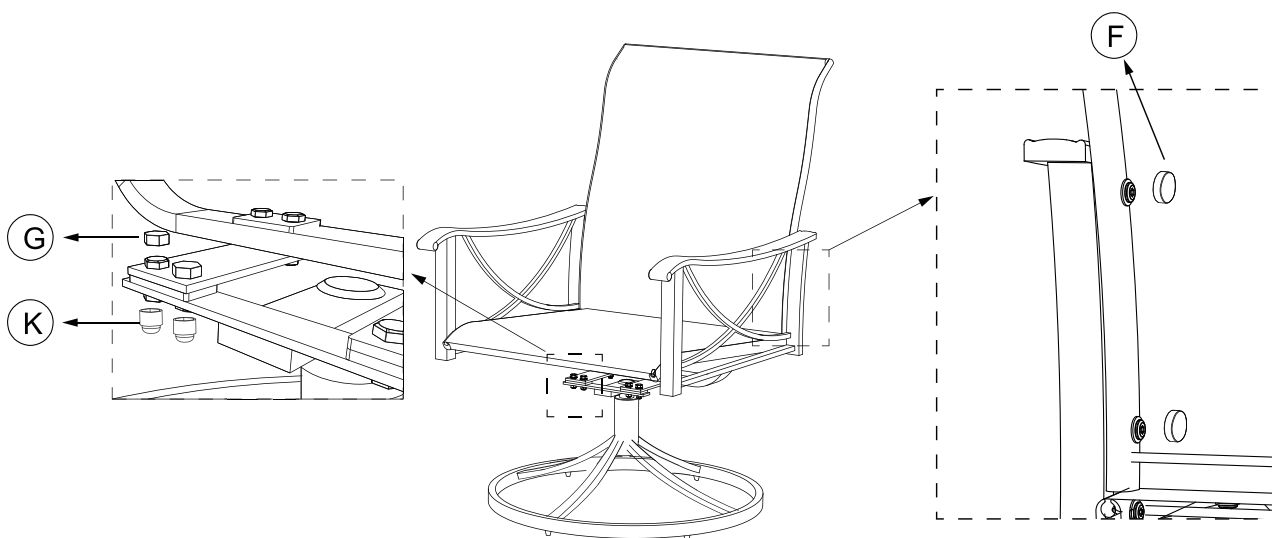

G

K

F



G×8



K×8



F×16