

The factory sun lounger

by Ramón Esteve

Vondom's The Factory collection, designed by Ramón Esteve, is inspired by the cast-iron architecture of New York. This collection combines an industrial aesthetic with modern comfort, offering a selection of furniture that brings character and sophistication to any outdoor space.

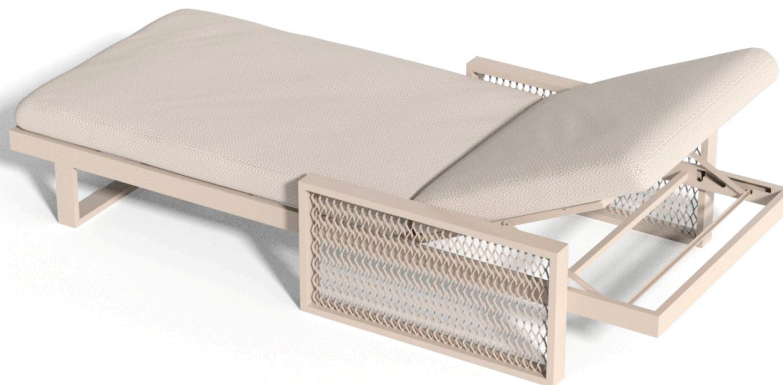

Info

Description

Made from aluminum and with a very comfortable padding. Our fabrics are available in a wide range of colours and very pleasant to touch. This collection is suitable for an indoor and an outdoor use.

Weight: 28.18 Kg

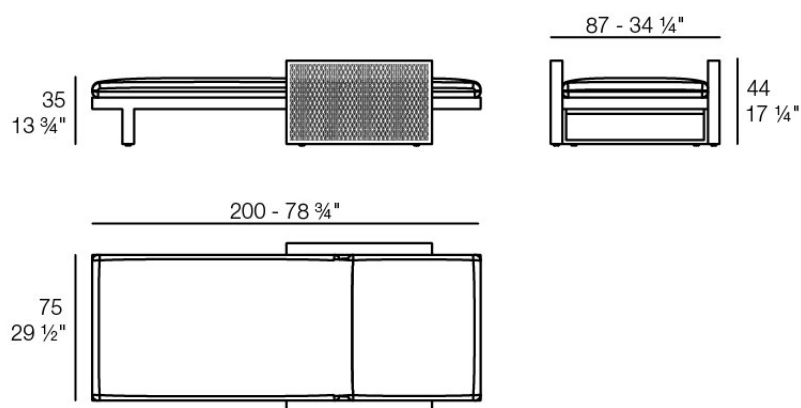

THE FACTORY Tumbona
THE FACTORY Sun Lounger

Finishes

finishes

ALUMINIUM

Ref. 54610



white



smoked



ecru



tortora



cream



garnet



brown



green



blue



gray



anthracite



black

Lacquered aluminium profile.

fabric

GETARIA

Ref. 54610CO

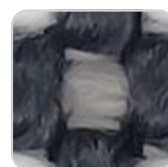

VONDOM

dune 10009 getaria



cream 10047 getaria

camel 10033 getaria



oasis 10007 getaria

tortora 10048 getaria



blue 10024 getaria

granite 10008 getaria



garnet 10046 getaria

gallant 10025 getaria



pearl 10006 getaria



black 10044 getaria



ocean 10023 getaria



aquamarine 10003
getaria



anthracite 10043
getaria

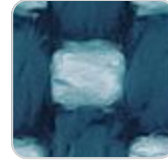

emerald 10016
getaria



oversea 10002 getaria



white 10041 getaria



niord 10015 getaria

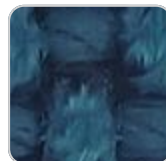

green 10053 getaria

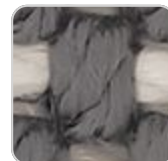

moon 10040 getaria



aphrodite 10013
getaria



brown 10050 getaria



terra 10039 getaria

Group 2. Premium high density 100% acrylic fabric, available in a wide range of colors.

BAIONA Ref. 54610CO

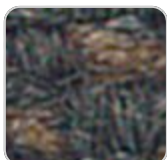

black 10114 baiona



clay 10106 baiona



gray 10113 baiona

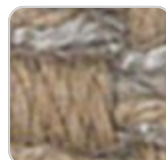

camel 10104 baiona

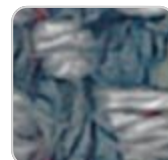

blue 10112 baiona

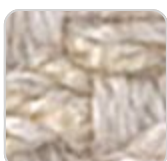

cream 10103 baiona

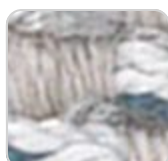

ocean 10111 baiona



tortora 10102 baiona

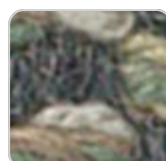

green 10110 baiona

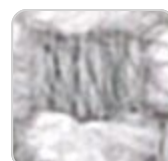

ecru 10101 baiona

VONDOM



white 10100 baiona



jade 10109 baiona



brown 10108 baiona



garnet 10107 baiona

Group 1C. High density 100% acrylic fabric, which provides a solid feel. It has an irregular pattern that adds a handcrafted touch.

CALELLA

Ref. 54610CO



blue 10127 calella



jade 10126 calella



clay 10125 calella



mustard 10124 calella



cream 10123 calella



tortora 10122 calella



anthracite 10129
calella

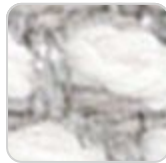

ecru 10121 calella



gray 10128 calella



white 10120 calella

Group 1C. PFAS-free 100% acrylic fabric with a rich and unusual texture and an exceptional softness, which enhances the comfort of the furniture.

FISTERRA

Ref. 54610CO



cream 10132 fisterra



white 10130 fisterra



ecru 10131 fisterra



tortora 10135 fisterra



camel 10134 fisterra

VONDOM



peach 10146 fisterra



clay 10137 fisterra



garnet 10138 fisterra

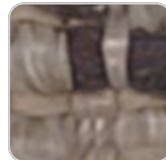

brown 10136 fisterra

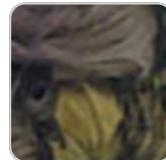

olive 10145 fisterra



jade 10139 fisterra



green 10140 fisterra



ocean 10141 fisterra

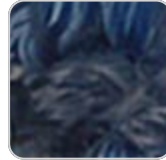

blue 10142 fisterra



gray 10143 fisterra



anthracite 10144
fisterra



black 10147 fisterra

Group 1C. 100% acrylic fabric, with a distinctive irregular marbled pattern and a soft feel.

PORTONOVO Ref. 54610CO



mustard 10155
portonovo



camel 10154
portonovo



ocean 10161
portonovo



cream 10153
portonovo

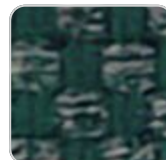

green 10160
portonovo



tortora 10152
portonovo



jade 10159 portonovo

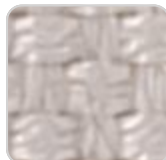

ecru 10151 portonovo



black 10165
portonovo

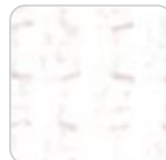

white 10150
portonovo



anthracite 10164
portonovo

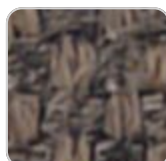

brown 10158
portonovo



gray 10163 portonovo

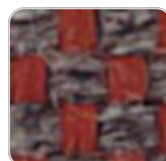

garnet 10157
portonovo

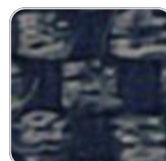

blue 10162 portonovo

VONDOM



clay 10156 portonovo

Group 1A. 100% acrylic fabric, with a flat and simple design, which adapts to any decorative style.

ZUMAIA

Ref. 54610CO



blue 10203 zumaia



garnet 10202 zumaia



cream 10201 zumaia



white 10200 zumaia



black 10205 zumaia



green 10204 zumaia

Group 2. Elegant 100% acrylic fabric, with a soft terry, pleasant to the touch and a unique color combination.

SUANCES

Ref. 54610CO



mustard 10305
suances



anthracite 10314
suances



camel 10304 suances



gray 10313 suances



ocean 10311 suances

VONDOM



cream 10303 suances



blue 10312 suances



green 10310 suances



tortora 10302 suances



jade 10309 suances



ecru 10301 suances



brown 10308 suances



white 10300 suances



olive 10317 suances



garnet 10307 suances



peach 10316 suances



clay 10306 suances



black 10315 suances

Group 2. Bocol fabric, which stands out for its warmth and softness, with matching colors that add depth and elegance.

RIBADEO

Ref. 54610CO



camel 10324 ribadeo



olive 10336 ribadeo



blue 10332 ribadeo



ocean 10331 ribadeo

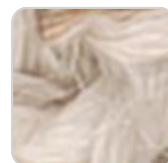

cream 10323 ribadeo



green 10330 ribadeo



tortora 10322 ribadeo



jade 10329 ribadeo



ecru 10321 ribadeo



brown 10328 ribadeo

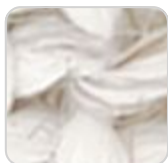

white 10320 ribadeo



peach 10335 ribadeo



garnet 10327 ribadeo



clay 10326 ribadeo

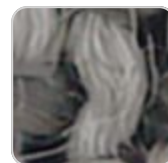

anthracite 10334
ribadeo

VONDOM



mustard 10325
ribadeo



mint 10337 ribadeo



gray 10333 ribadeo

Group 2. Soft fabric with marbled yarns of different thicknesses that create a rich and visually interesting texture. Its Linen look adds a touch of natural style.

LOURO

Ref. 54610CO



brown 10348 louro



olive 10356 louro



garnet 10347 louro

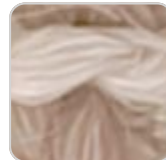

peach 10355 louro



clay 10346 louro



anthracite 10354 louro



gray 10353 louro



mustard 10345 louro

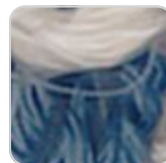

blue 10352 louro

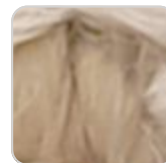

camel 10344 louro



ocean 10351 louro

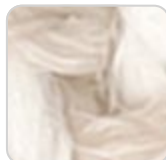

cream 10343 louro



green 10350 louro



tortora 10342 louro



jade 10349 louro

Group 2. Soft and versatile fabric, which presents a neutral base color that makes it easy to combine with different colors and fabrics.

ALTEA

Ref. 54610CO

VONDOM



tortora 1102 altea



white 1100 altea



ecru 1111 altea



cream 1103 altea



camel 1120 altea



clay 1122 altea



garnet 1106 altea



brown 1104 altea



jade 1125 altea



ocean 1123 altea



blue 1114 altea



gray 1101 altea



anthracite 1124 altea



black 1105 altea

Group 1A. Soft outdoor fabric with leather-like texture.

AROUSA Ref. 54610CO



ecru 1221 arousa



white 1219 arousa



tortora 1209 arousa

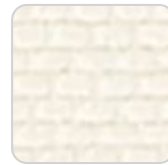

cream 1220 arousa



camel 1230 arousa



clay 1231 arousa



garnet 1223 arousa



brown 1214 arousa

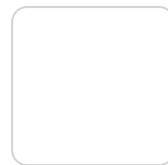

jade 1235 arousa



blue 1222 arousa



gray 1208 arousa



anthracite 1210
arousa

Group 1B. Soft outdoor fabric with shiny finish.

Ambients

