

ATTENTIONS

1) After installation, in order to ensure that the chair can work normally, please follow the steps below to check:

- ① Check all the cables are connected correctly.
Check if the cables under the seat is loosed or not.
- ② Check if the light of the transformer is on.
- ③ Check if the light of remote is on.
- ④ Make sure the motor have a weak buzz (48 decibel) if the three above steps are normal.
- ⑤ Use some lubricant on the joints motor and mechanism of the chair.

2) If the chair does not work properly, please tell us your checking result. It is best to shoot video and send it to our e-mail, we can understand your problem faster and more accurately. Any questions or concerns, please contact us:

Our engineer will see where is wrong with the chair and provide you a satisfied solution. (If the parts were broken, we would like to send the replacement parts to you.)

■ OUR BRAND STORY

Founded in 2001, Our company is specializing in living-room furniture. It researches, develops, manufactures and sells upholstered furniture with the aim to build a comfortable and eco-friendly environment.

Motion – our brand core conception, ergonomics and comfort, which is the most extraordinary beauty in the upholstered furniture. We devote to provide high quality sofa enjoyment for millions in the world by its simplified American style

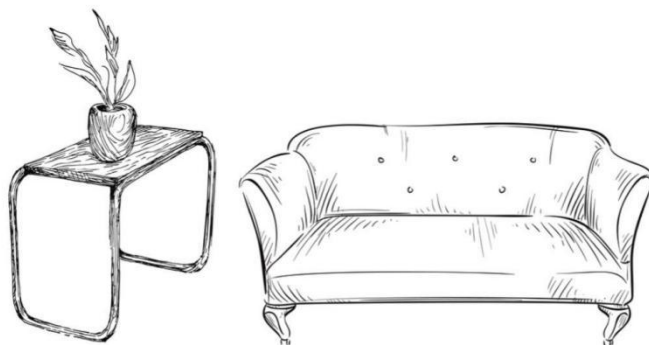



CONTENT

P1. Attention & Return Policy

P2. Brand Story

P3. Contents

P4. Product Specifications

P5. Accessories & Installation guidance

P6. Installation guidance

P7. Usage Information

P8. Clean Tips

P9. Attention

LIFT CHAIR: lift mechanism pushes the entire chair up to help the senior stand up easily without adding stress to back or knees

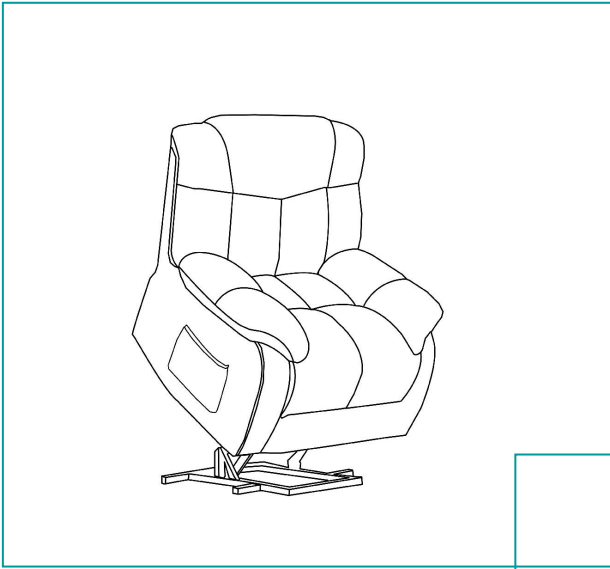
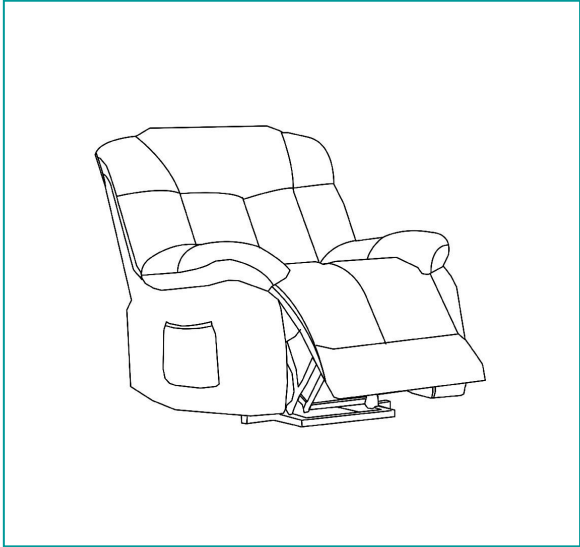



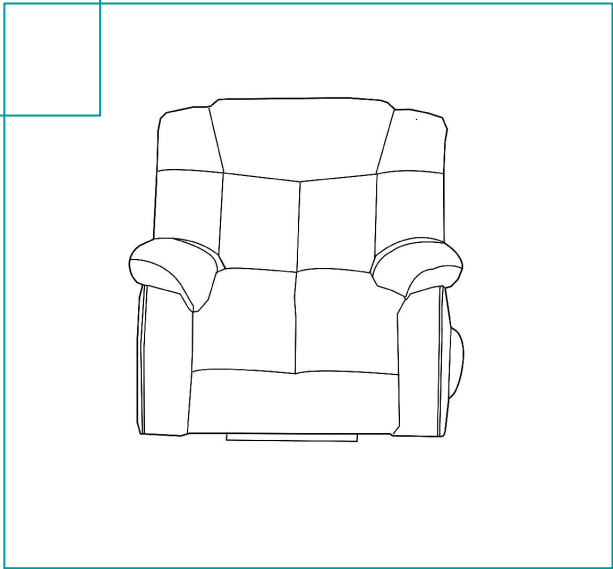

DURABLE MECHANISM: rigorously tested 25000 times to ensure mechanical and build durability.

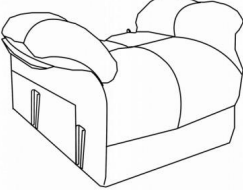
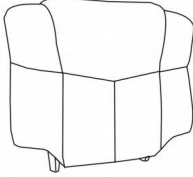
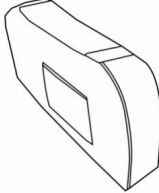
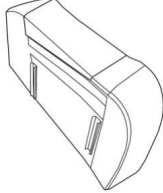

Ergonomically Design: made of high quality fabric and filled with high-density sponge, this recliner power lift chair is ideal for watching TV, sleeping, reading or simply relaxing.

FITTING LIST

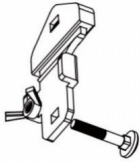
			
A 1* Chair Seat	B 1* Chair Back	C 1* Left Armrest	D 1* Right Armrest
			
E 1* Transformer	F 1* Power Cable	G 1* Remote Control	H 2* Supporting Feet

ASSEMBLY INSTRUCTIONS

STEP 1: Place the **Chair Seat (A)** on its back on a flat smooth surface. Take out **Supporting Feet (H)** from a small plastic bag. Assemble the two supporting feet as shown on the bottom of mechanism to avoid toppling and falling.

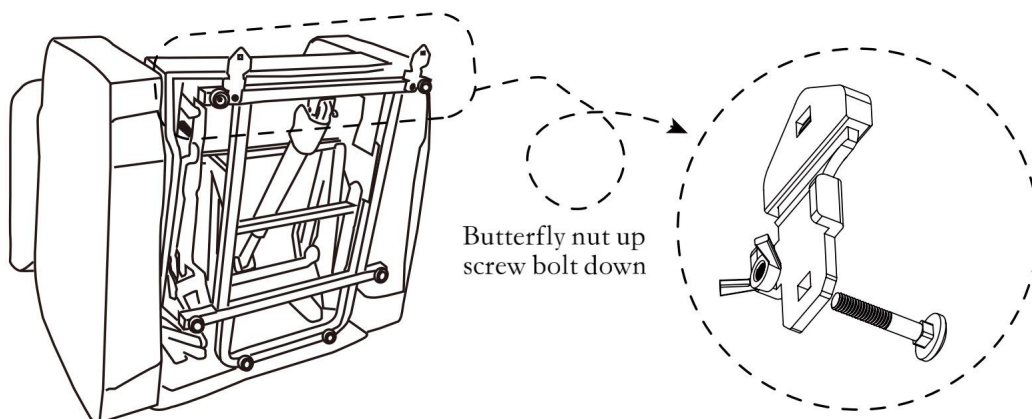

STEP 2: Attach **Left Armrest (C)** and **Right Armrest (D)** to **Chair Seat (A)** by aligning the metal grooves on **Chair Seat (A)**, **Left Armrest (C)** and **Right Armrest (D)**, then connect the **Armrest** to the **Chair Seat** with a zipper and stick it with Velcro.

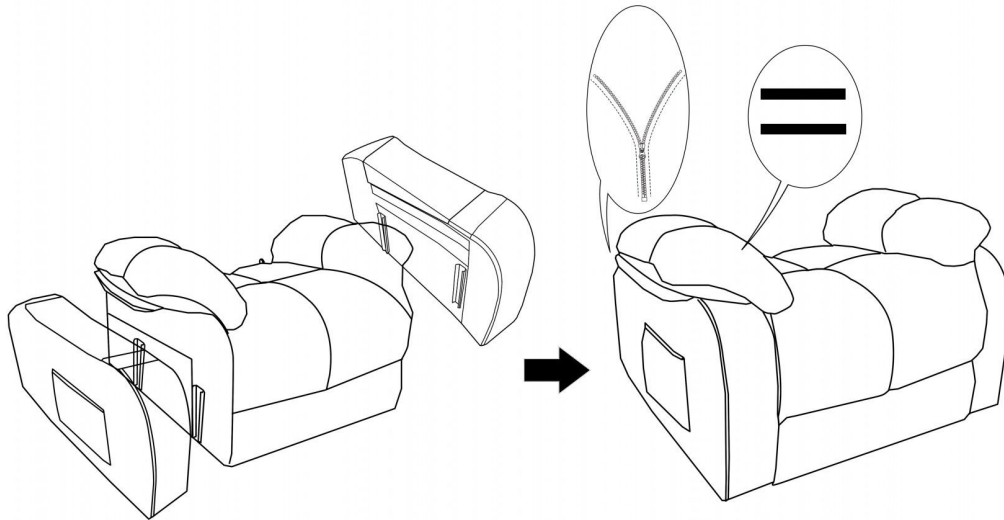

- **STEP 3:** Attach **Chair Back (B)** to **Chair Seat (A)** by aligning the metal grooves on backrest to brackets on the main frame as shown. Ensure the **Chair Back (B)** slides down fully over the brackets on the **Chair Seat (A)**.

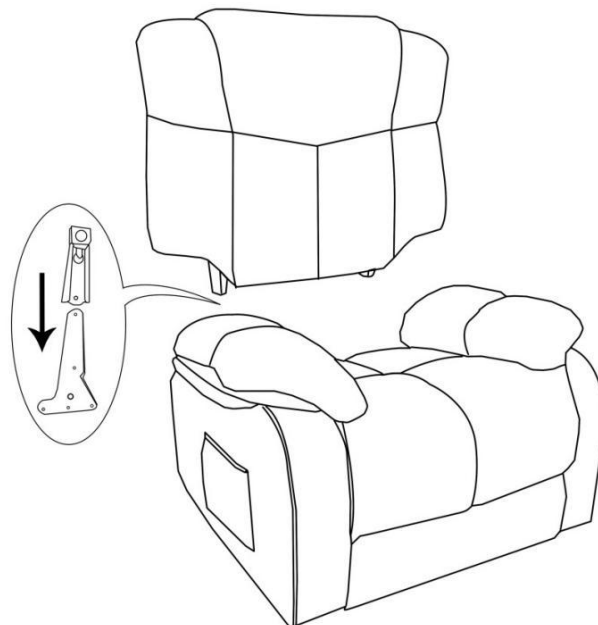

- **STEP 4:** Connect the **Transformer (E)** with the **Power Cable (F)** and connect the **Remote Control (G)** with the power cable in the side pocket.

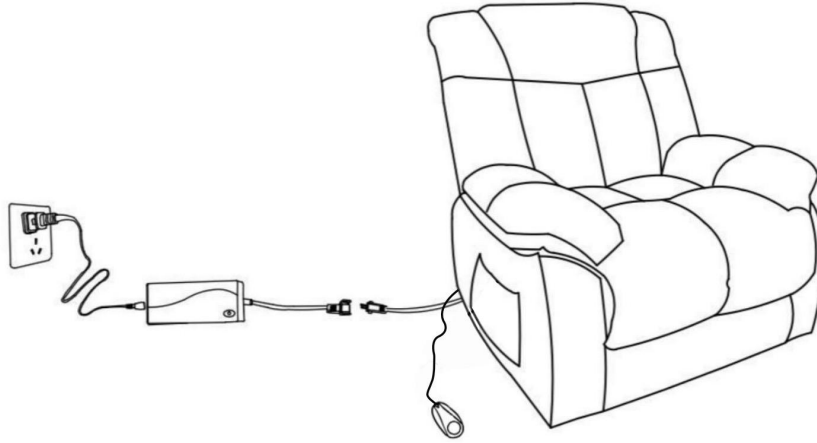

USAGE INFORMATIONS

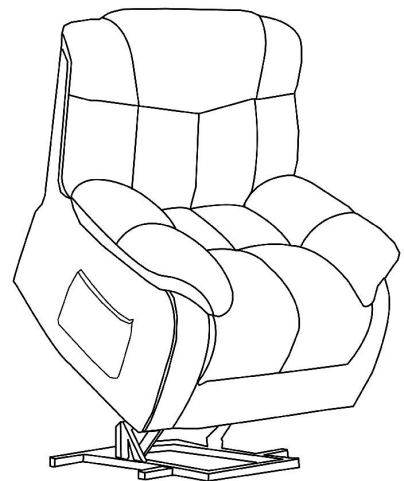
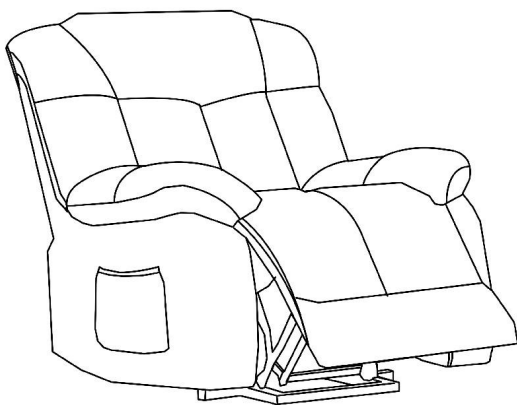

■ TO STORE OR CLEAN

Maintenance Instructions

Rotate reversible cushions regularly.

Turn over & Rotate

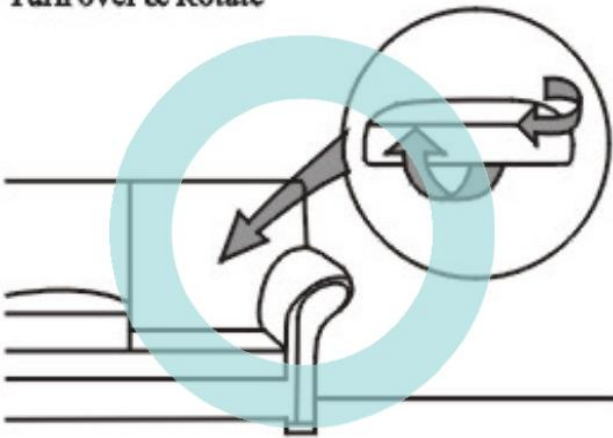

Vacuum your furniture regularly with



Do not expose your furniture to

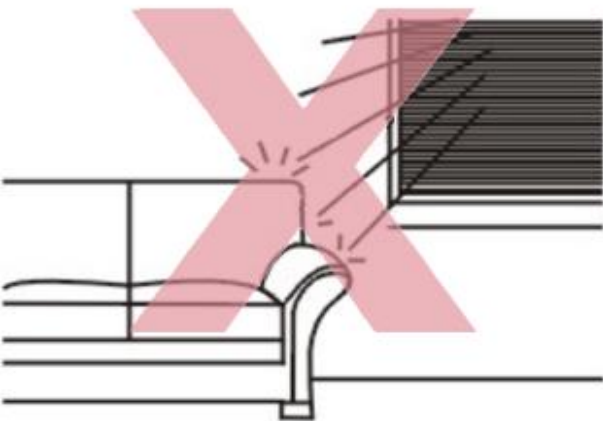

Do not place your furniture close to a



ATTENTIONS

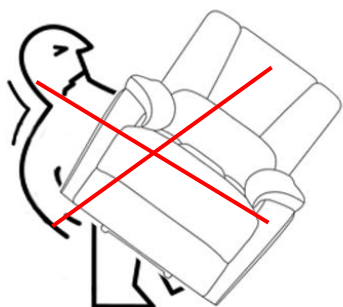

Moving the chair carefully to avoid falling armrests hurting your feet

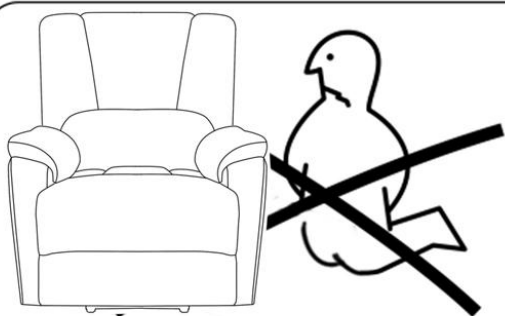
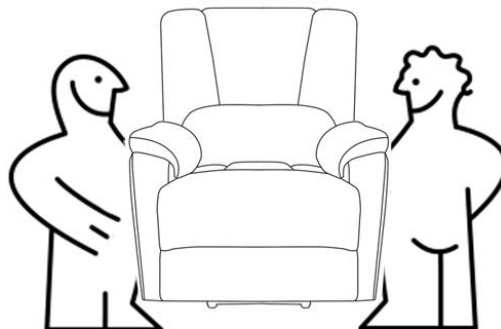

Put a carpet under the chair to protect your floor while assembling

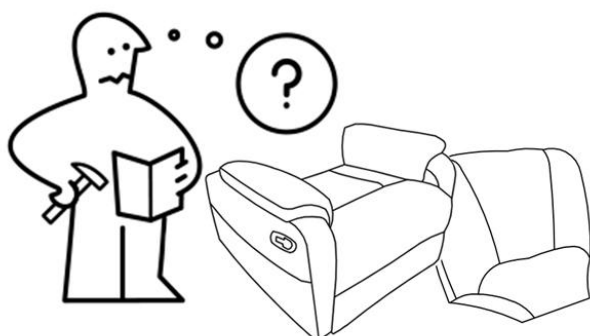
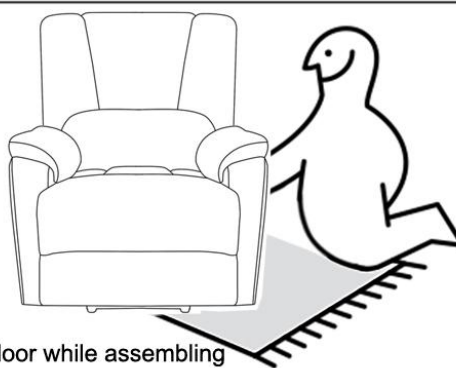

We believe that design can always light up your life.

If you have any questions or concerns, please feel free to contact us,we will reply within 24 hours.

