

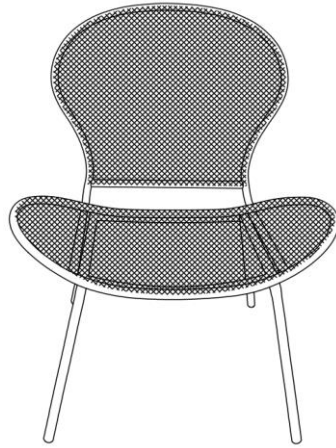

Assembly Instructions

Caution : You must read this before you proceed

Chair



Parts List

Label	Picture	Description	QTY
A		Chair Seat	1
B		Leg Frame	1

Hardware

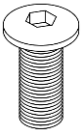
Label	Picture	Description	QTY
①		Bolt (M8*20mm)	5

②		Allen key	1
---	---	-----------	---

Assembly Preparation

Before Beginning Assembly:

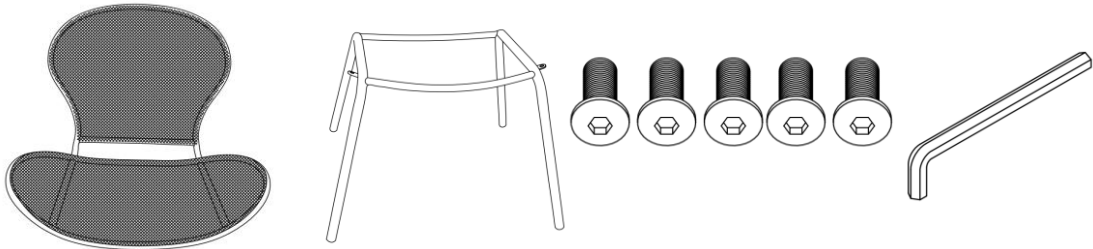

- Read instructions, cover to cover-



- Have 2 adults on hand for assembly-



- Do not assemble on flooring or carpet-



- Assemble on a clean non-marring surface (packing foam)-



- Save all packaging until finished-

Assembly Steps

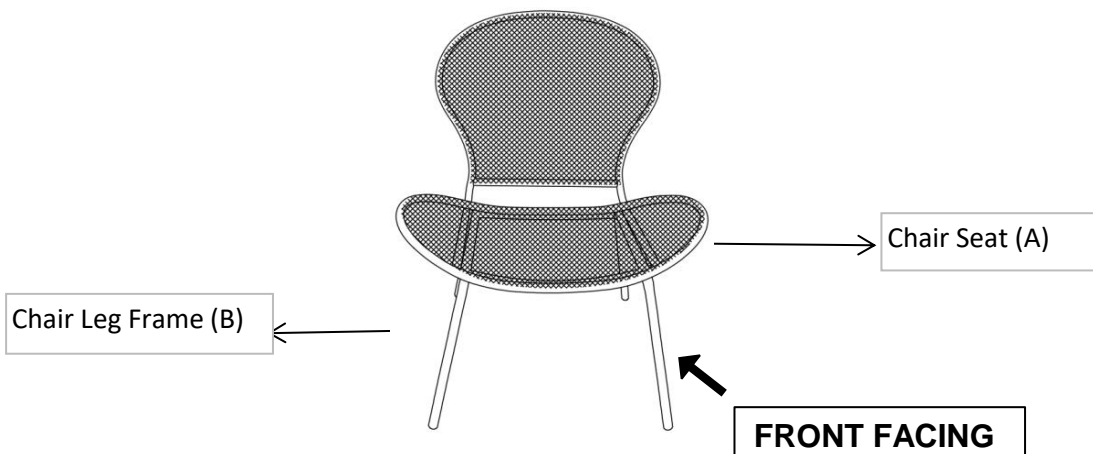

This Chair has multiple parts and may require up to some 30 minutes to assemble. To give you an overview of the Chair parts, the above picture is to help you put the various parts into perspective. Please read through the instructions herebelow to familiarise the parts and steps before assembly.

Assembly Steps

Step 1

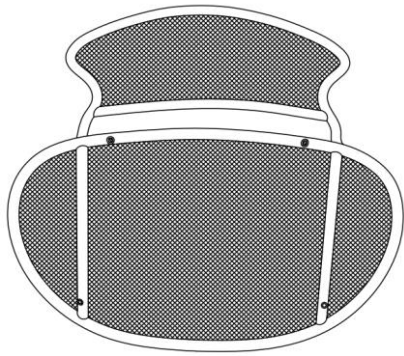

A

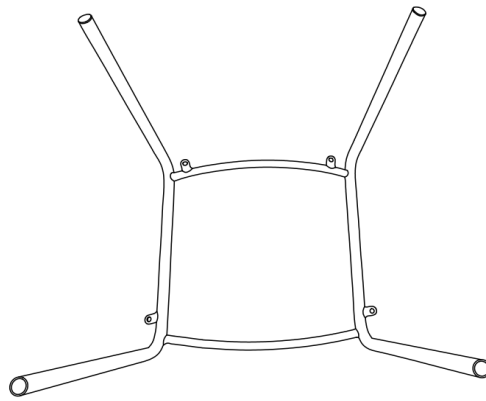

B

Unpack and place all parts on a clean, non-marring surface.
Position the Leg Frame (B) resting on its front, as show in Pix B, above.

Step 2

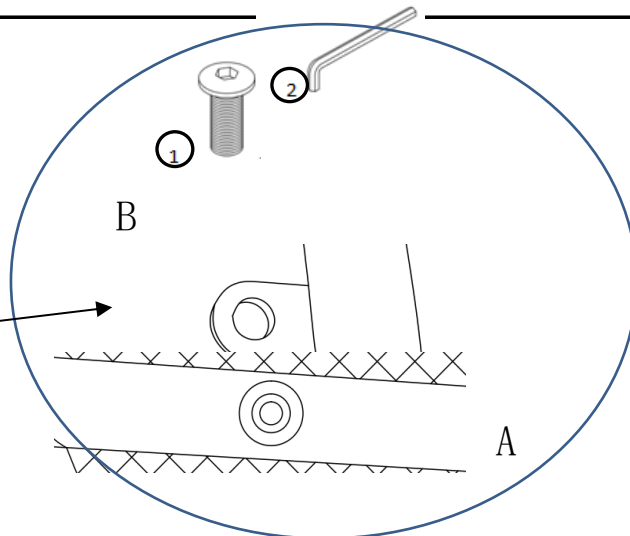
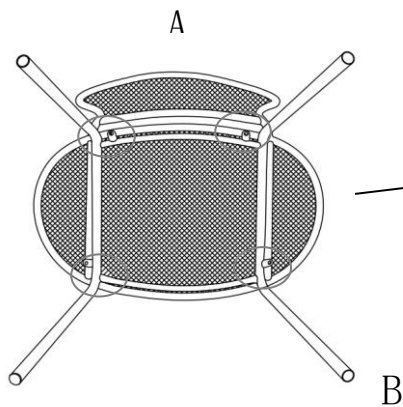

Lay the Chair seat(A) being floor facing, onto a flat soft clean surface .
Attach the Leg Frame(B) to the the Chair Seat(A) using Bolts(①) with Allen key(②).
Do not fully tighten Bolts.

Step 3

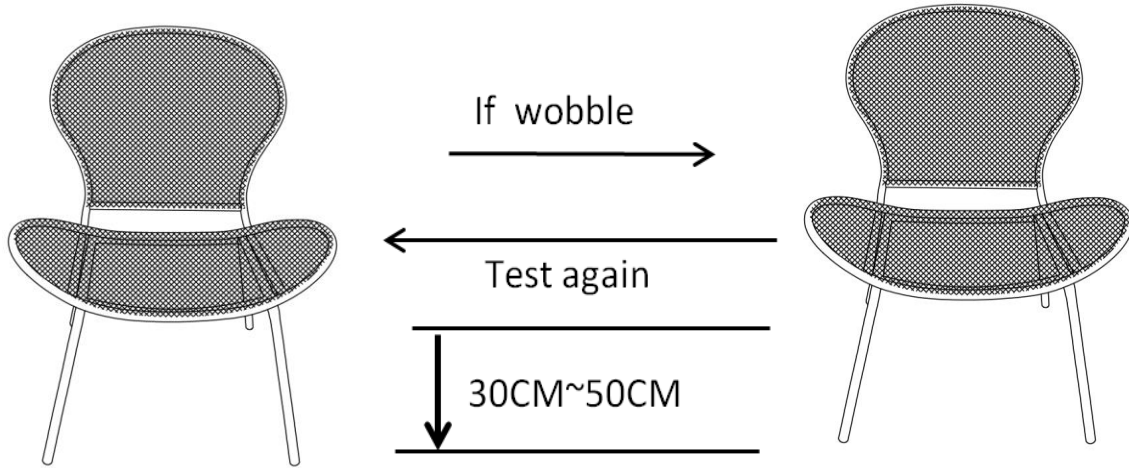

Place the chair on a LEVEL SURFACE to see if it wobbles.
If it wobbles, lift the chair to some 30cm to 50cm height from the ground.
Keep your feet and toes well away from the drop zone.
Drop the chair freely and vertically with the four legs, hitting the ground, at the same time.
This Drop Test will help to ensure that all the bolts and gaps to all reach full alignment status.
Test again for evenness on a LEVEL SURFACE.
If no wobbles found, lay down the chair and proceed to tighten all the bolts.

When tightening these bolts, tighten sequentially.

DO NOT tighten any screw fully and then towards the next one.

This would cause the frame to warp.

If there is still wobbles, loosen the bolts and execute this same drop tests.

IF CHAIR IS NOT STABLE , IT COULD LEAD TO DAMAGING THE PRODUCT.



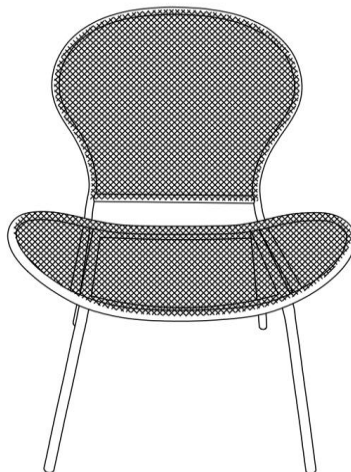













Step 4





Stand the Chair, then your Chair is ready for use.

This Chair can only be used on the flat and level surface.

Care & Maintenance

-   ● Do not put hot items directly on furniture surface
 -   ● Do not clean furniture with harsh cleansers or polish.
 -   ● To obtain the longest lifespan of your outdoor products, minimizing exposure to direct sunlight is recommended.
 -   ● Children should not climb or jump on the furniture.
 -   ● Do not write on furniture without a padded barrier to protect the surface.
 -   ● To obtain the longest lifespan of your outdoor products, avoid extended and lengthy exposure to rain, snow, and direct sunshine. Whenever possible cover the product and /or place under patio or awnings.
 -   ● Not for commercial use. For residential use only .
 -   ● Stains may be removed with mild soap solution and damp cloth.
-

-   ● Dust and pick-up spills using a clean, non-colored, lint-free cloth .