

Assembly Instructions

Warnings: You must read this before you proceed.

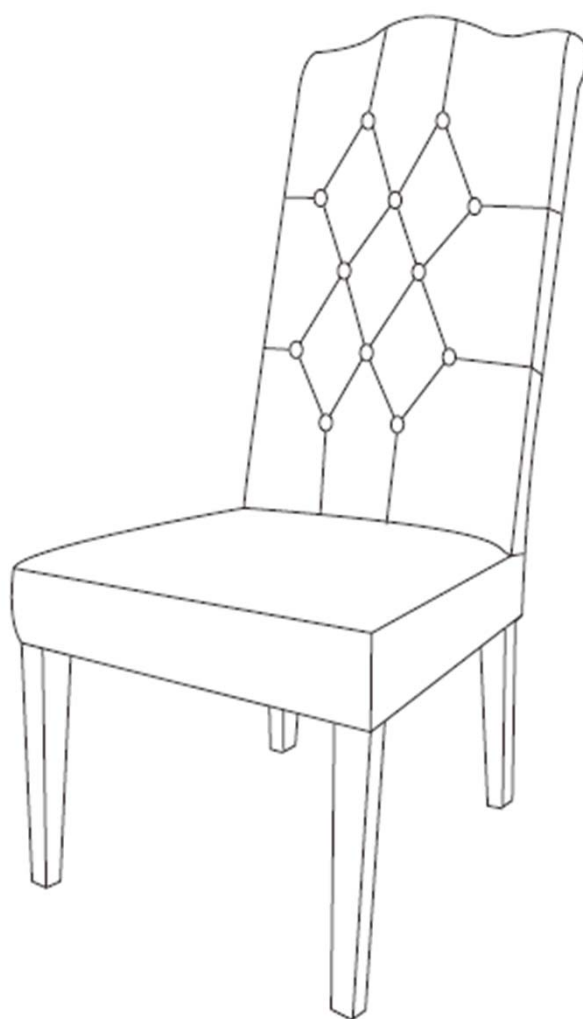



Dining Chair

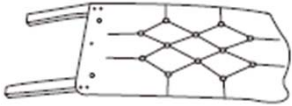
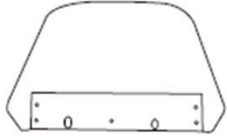
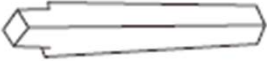

Parts List

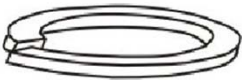
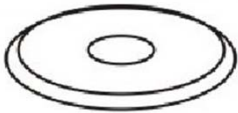

Part NO.	Picture	Description	Qty
A		Chair Back	1 pc
B		Chair Seat	1 pc
C		Front Leg	2 pcs



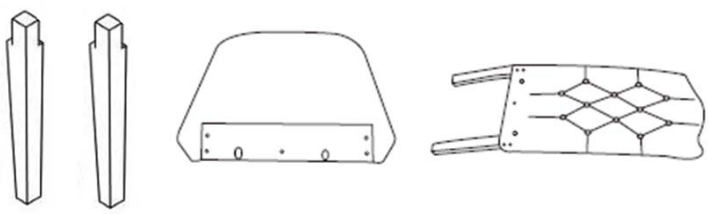
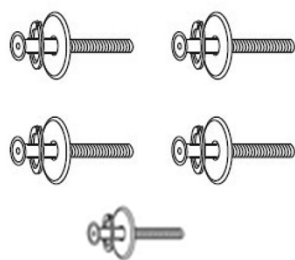
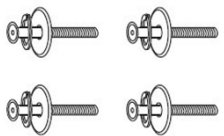

Hardware

Label	Picture	Description	Qty
a		60mm long bolt	5 pcs
b		70mm long bolt	4pcs
c		Spring Washer Ring	9 pcs
d		Flat Washer Ring	9 pcs
e		Allen Key	1 pc

Assembly Preparation

Before Beginning Assembly:

<p>Unpack and place all parts for clear visibility.</p>	
<p>Pack A for locking the back panel of the seat to the horizontal panel of the backrest: Four Dia.M8 Bolt:70mm(b)+one Dia.M8 Bolt:60mm(a)+five spring washer(c)+five flat washer(d)</p>	
<p>Pack B for Locking the front legs to the front corner blocks of the seat: Four Dia.M8 Bolt:60mm(a)+four spring washer(c)+four flat washer(d)</p>	
<p>Allen Key</p>	

-  • Read instructions, cover to cover-
-  • Have 2 adults on hand for assembly-
-  • Do not assemble on flooring or carpet-
-  • Assemble on a clean non-marring surface (packing foam)-
-  • Save all packaging until finished-

Assembly Steps

Step 1

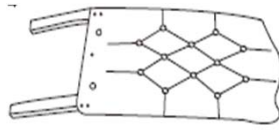

A

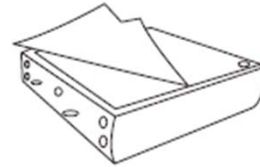

B

Place the Chair Back(A) on a soft surface to avoid any scratches or damages to the product.
REMOVE the Seat Base Cover from the Chair Seat(B), take out the front legs and hardware accessories.

Step 2

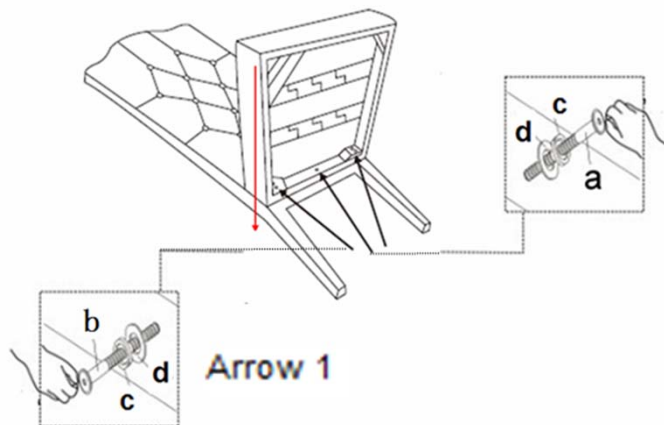

Put the chair back(A) onto a flat table or panel.
Align the positioning dowels on the chair seat panel with the holes located on the chair back panel. Use your left hand to push the seat frame floorwards, depicted by Arrow 1.
This action helps to ensure the chair seat(B) is pressed towards to the chair back(A) with no gap between these.
Then, lock the middle hole and the corner holes.
The hardware for these are : Four Dia.M8 Bolt:70mm(b)+one Dia.M8 Bolt:60mm(a)+five spring washer(c)+five flat washer(d)with the Allen key(e).
At this point of assembly, DO NOT overfasten the connections.

Step 3

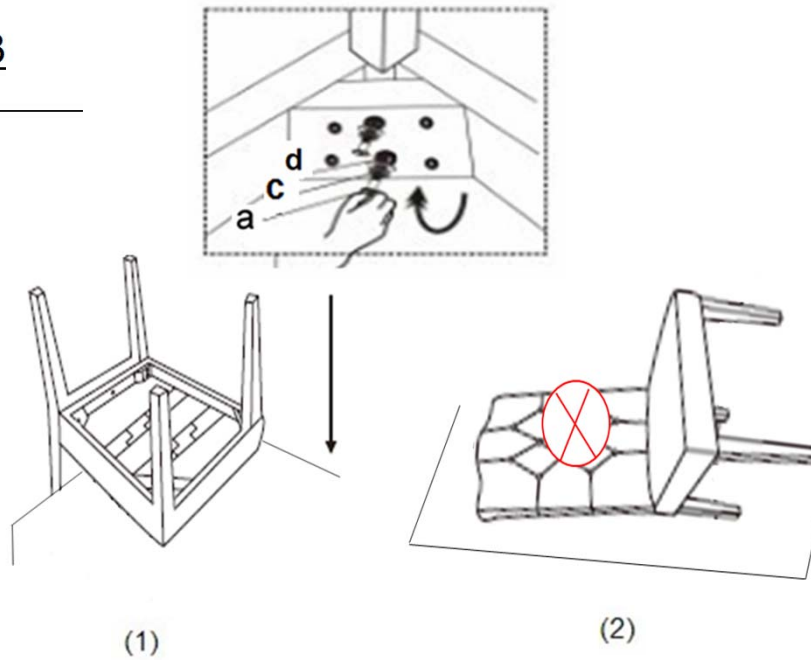

Next, place the chair onto the side of a table as seen in Picture 1. You will now have the chair bottom and all 4-legs facing skywards. Insert each front leg completely vertically into each seat frame corner.

PRESS FIRMLY DOWN with your hand until there is no gap.

WARNING!! DO NOT POSITION THE FRONT LEG AS SHOWN IN PICTURE 2 .

THIS PICTURE SHOWS THE CHAIR BACK STAYS AGAINST THE GROUND and THE FRONT LEGS HORIZONTAL IN MIDAIR.

Now tighten the bottom bolt first, then the bolt on the top by using Four Dia.M8 Bolt:60mm(a)+four spring washer(c)+four flat washer(d). **DO NOT** tighten the top bolt first.

WARNING!! DO NOT OVER TIGHTEN. OVER TIGHTENING COULD LEAD TO DAMAGE OF THE PRODUCT. TIGHTEN ONLY UNTIL SECURE AND STABLE.

Step 4

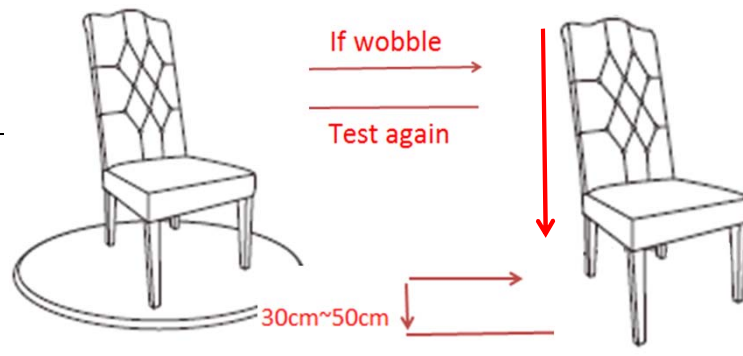

Place the chair on a LEVEL SURFACE to see if it wobbles.

If it wobbles, lift the chair to some 30cm to 50cm height from the ground.

Keep your feet and toes well away from the drop zone.

Drop the chair freely and vertically with the four legs, hitting the ground, at the same time.

This Drop Test will help to ensure that all the bolts and gaps to all reach full alignment status.

Test again for evenness on a LEVEL SURFACE.

If no wobbles found, proceed to tighten all the bolts.

CAUTION : When tightening these bolts, tighten sequentially.

DO NOT tighten any screw fully and then towards the next one.

This would cause the frame to warp.

If there is still wobbles, loosen the bolts and execute this same drop tests.





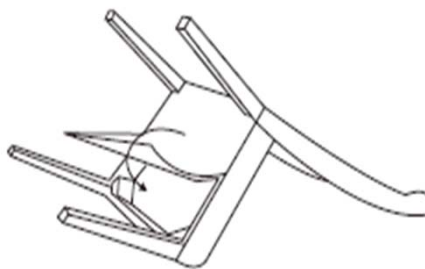





WARNING!! IF CHAIR IS NOT STABLE , IT COULD LEAD TO DAMAGING THE PRODUCT.

Step 5



Finally, seal the Seat Base Cover back to the original underside of the chair. Smooth down with your hand on all 4 sides velcro tapes at the edge of the seat boxon . Then turn it the right side up, the chair is ready for use.

Care & Maintenance

-  Do not put hot items directly on furniture surface
 -  Do not clean furniture with harsh cleansers or polish.
 -  Do not place furniture under direct sunlight.
 -  Do not place furniture near heating or cooling vents.
 -  Do not write on furniture without a padded barrier to protect the surface.
 -  Do not place furniture outside . For indoor use only .
 -  Not for commercial use. For residential use only .
 -  Stains may be removed with mild soap solution and damp cloth.
 -  Children should not climb or jump on the furniture.
-
-  Dust and pick-up spills using a clean, non-colored, lint-free cloth .