



# MIRROR

**Installation Instruction**

# MIRROR PRODUCT POWER METER

LED FULL LENGTH MIRROR PARAMETERS ( Straight Light Belt )		
Product Specification	Power	Lumen
1420*400	29W	4843LM
1650*550	36.3W	6062LM
1800*700	42W	5335LM
1100*400	22W	3221LM
LED FULL LENGTH MIRROR PARAMETERS ( Triangular Light Belt )		
Product Specification	Power	Lumen
1600*400	31W	5117LM
1600*500	33W	5511LM
1600*550	35.8W	5978LM

THE PERFORMANCE PARAMETERS	
Input Voltage	AC100-240V
Output Voltage	DC 24V
Working Hours	50000h
CRI	≥80

# PRODUCT DISPLAY

## Mirror Accessories

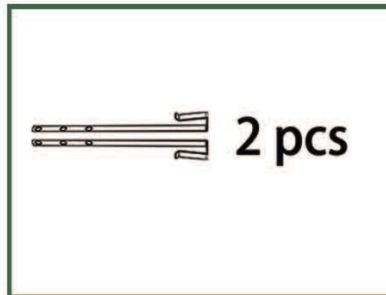
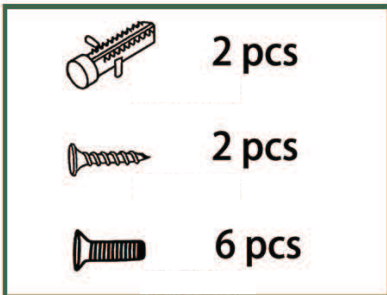

## Installation Instruction

### Option 1

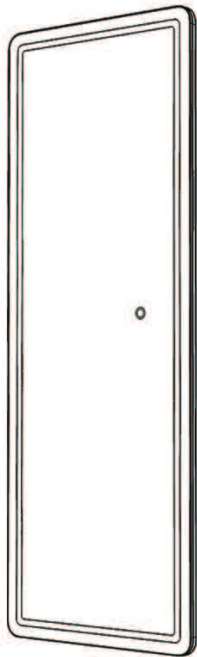

### Step 1

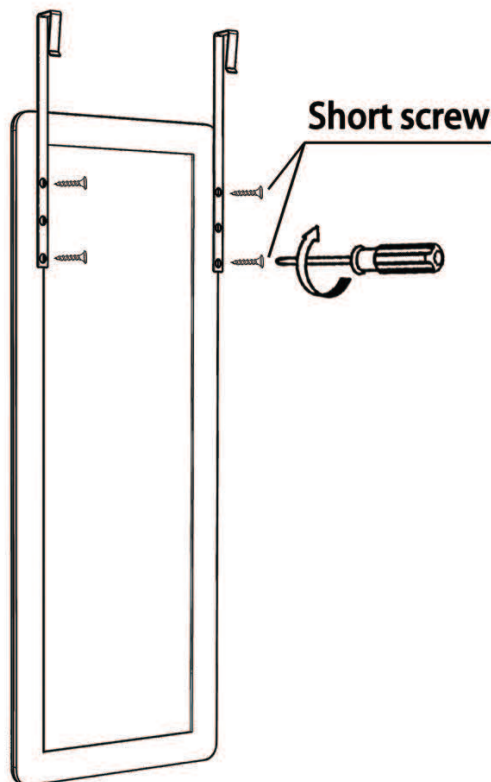

Tighten the screws with a screwdriver to fix the bracket

### Step 2

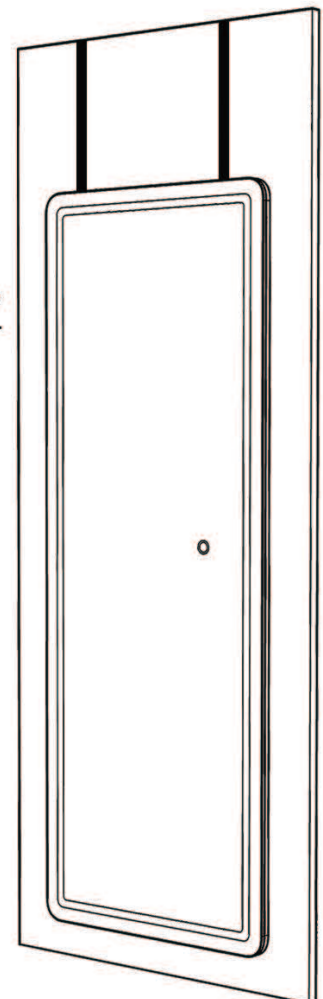

# PRODUCT DISPLAY

## Wall Mount

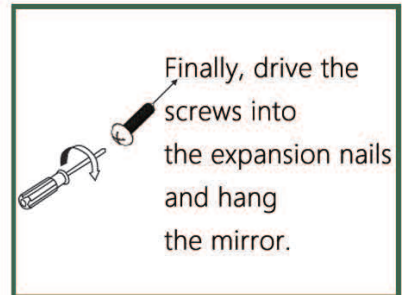
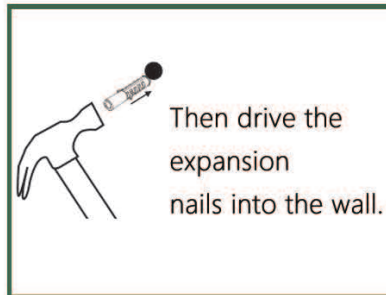
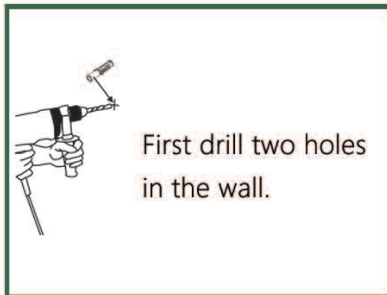

## Option2

