





















## Hardware

NO.	Quantity	Accessory
A	4	 Metal Support A
B	4	 Metal Support B
C	12	 Metal Support C
D	12	 Gaske 33 mm
E	44	 Screw 8X25 mm
F	6	 Plastic leg
G	4	 Nut
H	4	 Center Leg
I	1	 Allen Wrench 5mm
J	1	 Wrench 17mm-19mm

## King Bed

## Tools Required

Power tools NOT recommended

NO.	Quantity	Accessory
A	4	 Metal Support A
B	4	 Metal Support B
C	10	 Metal Support C
D	10	 Gaske 33 mm
E	42	 Screw 8X25 mm
F	6	 Plastic leg
G	4	 Nut
H	2	 Center Leg
I	1	 Allen Wrench 5mm
J	1	 Wrench 17mm-19mm

## Queen Bed

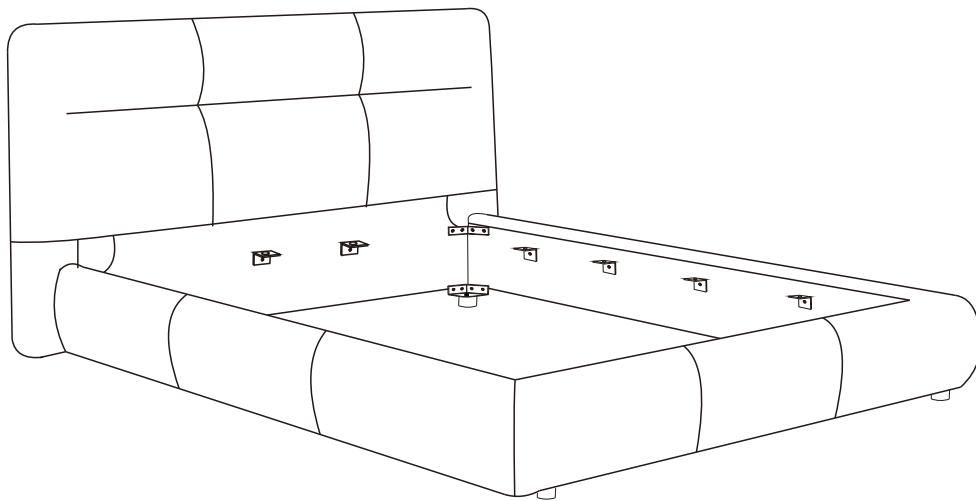

- 1 Install plastic foot G to headboard, siderails

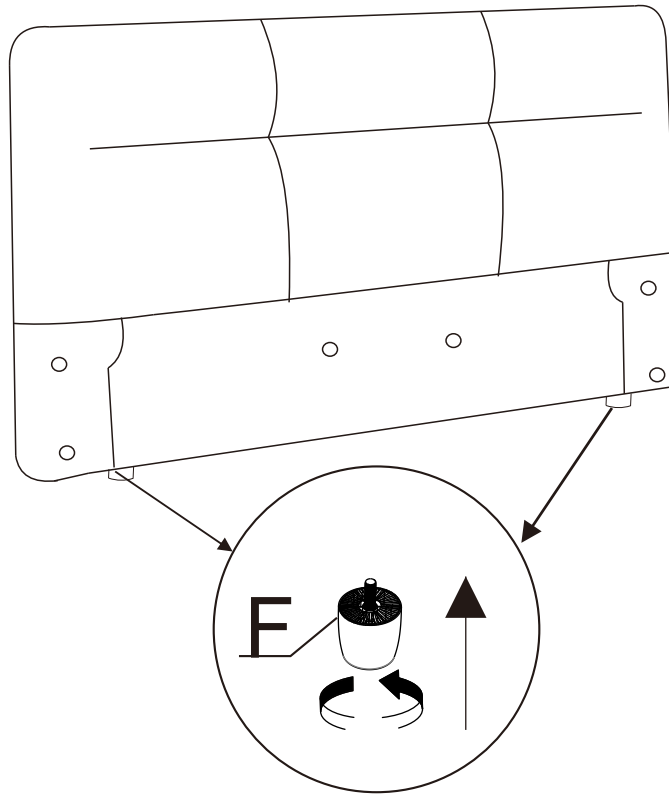

- ② Instal Metal support A with screw D to fix headboard, siderails and footboard.

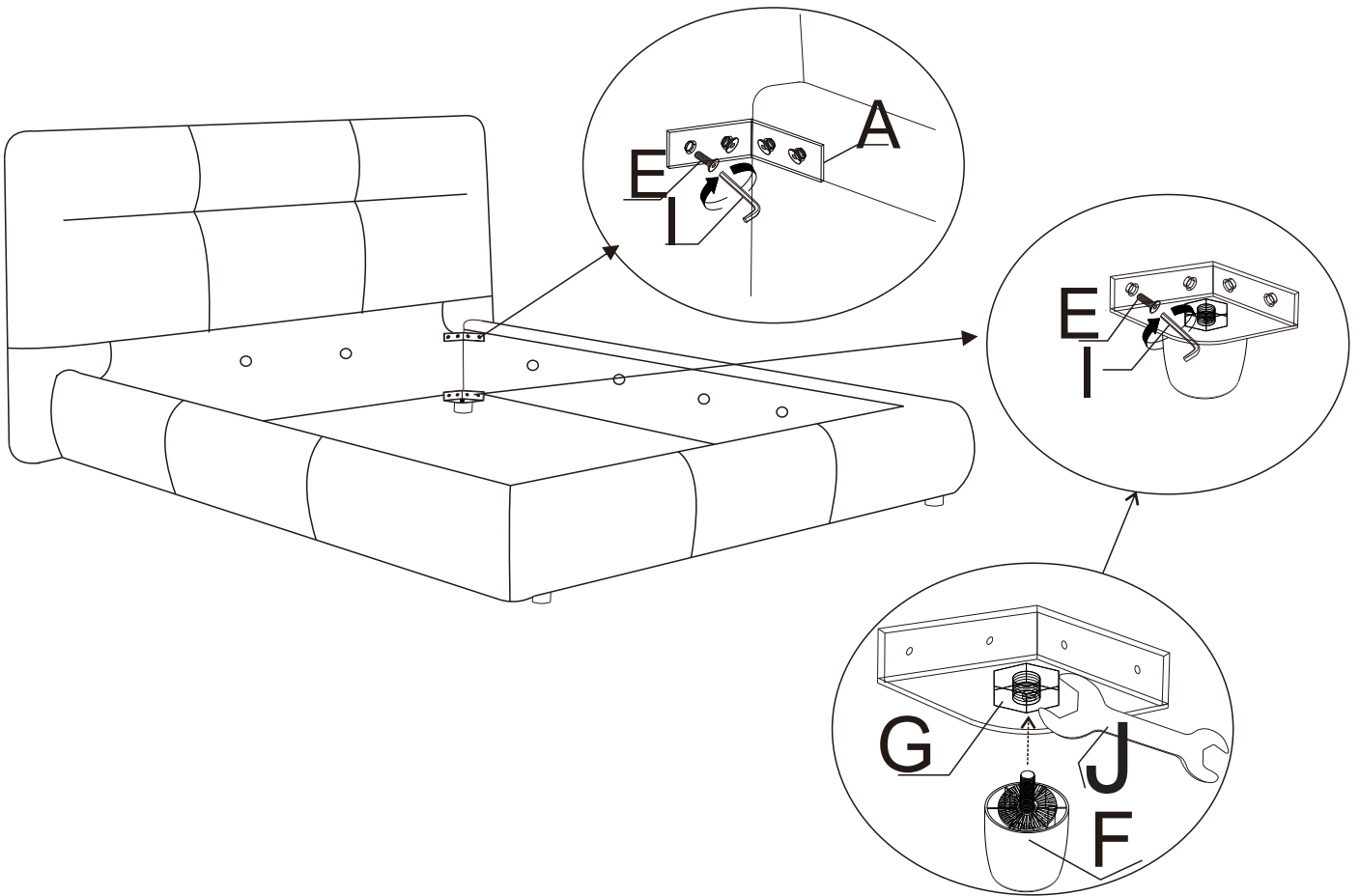

- 4 Fix metal support C with screw E and stick Gasket E.

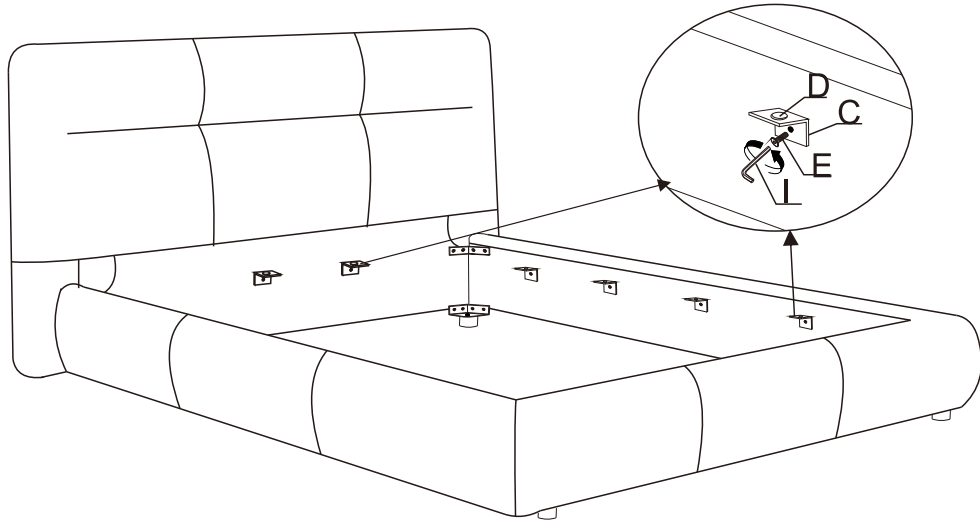

- 5 Install H legon slat and put the slat on the bed.

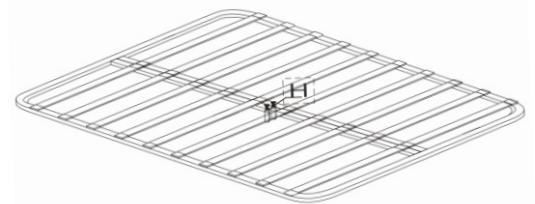

Queen Bed

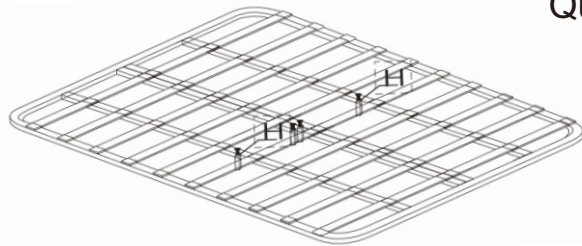

King Bed

