

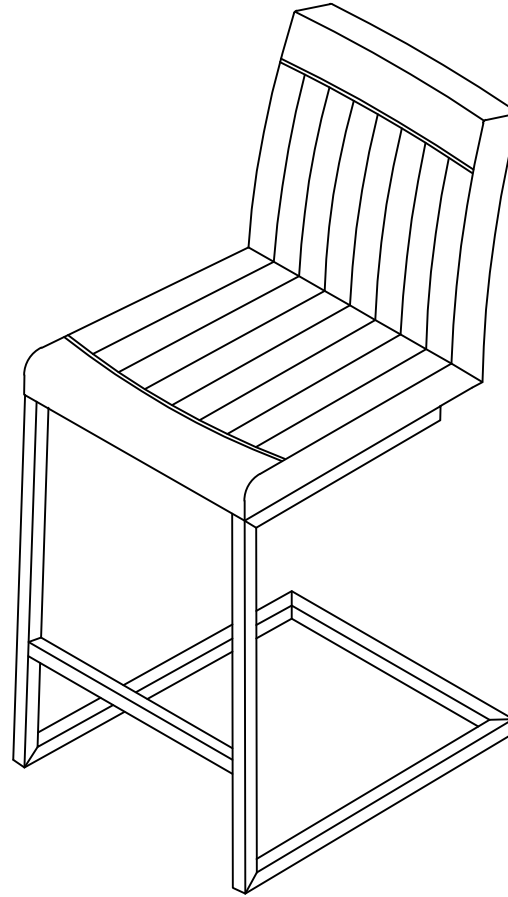

STEP1



STEP2

A		M6*45	4
B		4#	1