

(Queen&Full)

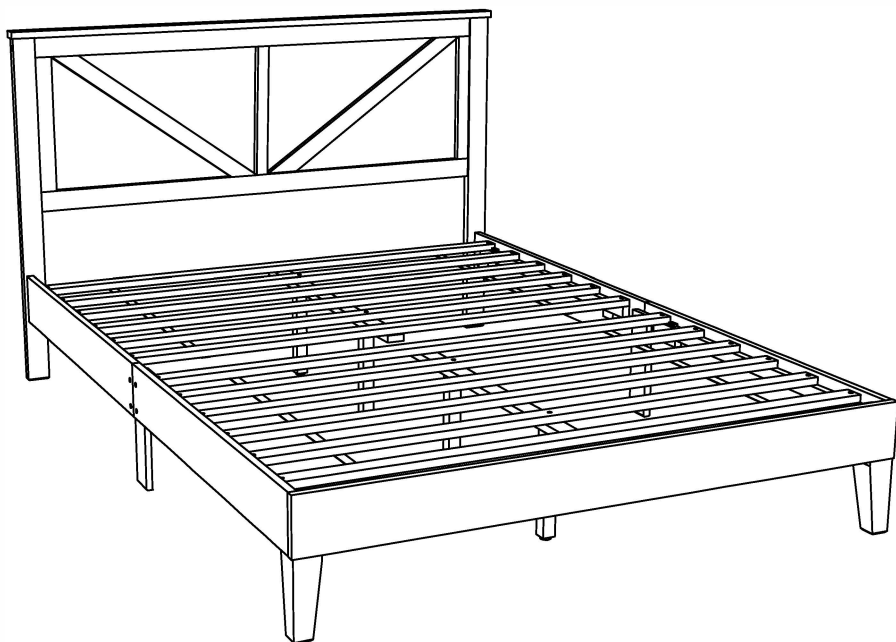

EN - Please read this instruction manual carefully before attempting to install.

DE - Bitte lesen Sie diese Bedienungsanleitung vor der Montage gründlich durch.

ES - Por favor lea con atención el manual de instrucciones antes de llevar a cabo el ensamble.

FR - Lisez attentivement cette notice avant de commencer le montage.

IT - Si prega di consultare il libretto delle istruzioni prima del montaggio.

IMPORTANT/WICHTIG/ATENCIÓN

IMPORTANT/IMPORTANTE



EN - We recommend **2** or more people to install.
DE - Wir empfehlen, dass die Montage von **2** oder mehreren Personen durchgeführt werden sollte.
ES - Recomendamos realizar el ensamble con **2** o más personas.
FR - Il est recommandé d'effectuer le montage à **2** personne(s) ou plus.
IT - È necessaria la presenza di **2** o più persone per il montaggio di questo prodotto.



EN - The expected assembly time is **1 h**.
DE - Die Montagezeit beträgt durchschnittlich **1 h**.
ES - El tiempo aproximado de ensamble es de **1 h**.
FR - Le temps nécessaire est estimé à **1 h**.
IT - Il tempo previsto per il corretto assemblaggio è di **1 h**.



EN - Not intended for use by children.
DE - Nicht geeignet für Kinder.
ES - Producto no apto para niños.
FR - Produit non destiné à être utilisé par des enfants.
IT - Questo prodotto non è destinato all'uso da parte dei bambini.











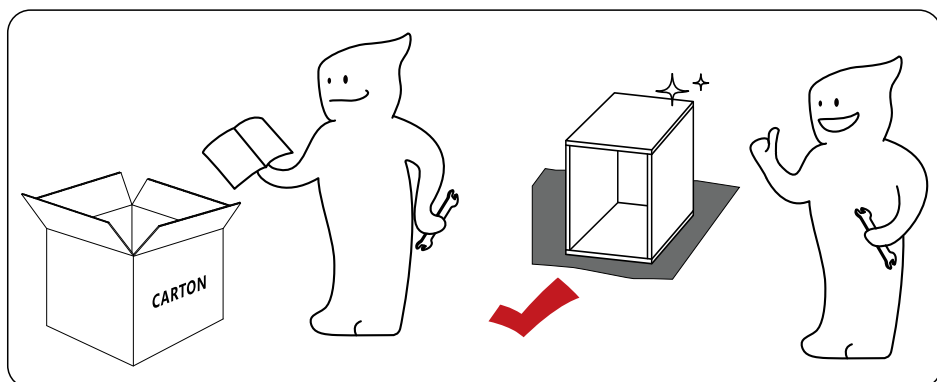
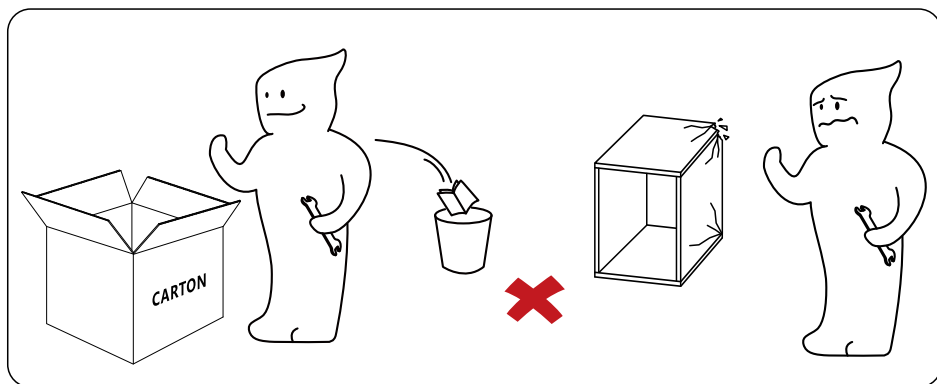

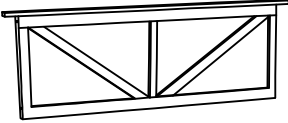
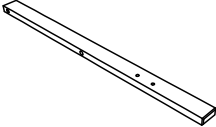





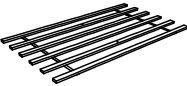
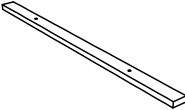

EN - Keep away from fire or other heat sources.
DE - Bitte von Feuer und Hitzequellen fernhalten.
ES - Manténgase alejado de las llamas y otras fuentes de calor.
FR - Tenir à distance des flammes et autres sources de chaleur.
IT - Tenere lontano dal fuoco o da altre fonti di calore.

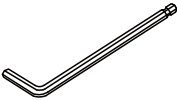

EN - We recommend wearing protective gloves.
DE - Wir empfehlen das Tragen von Schutzhandschuhen.
ES - Recomendamos el uso de guantes de seguridad.
FR - Il est recommandé de porter des gants de protection.
IT - Per il processo di assemblaggio, consigliamo fortemente l'utilizzo di guanti protettivi.





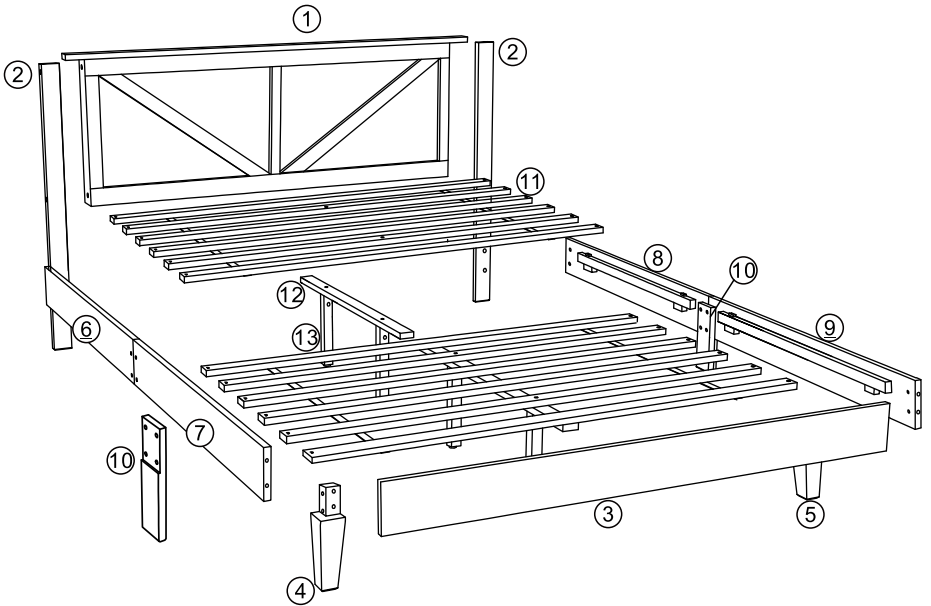
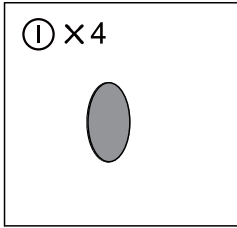

- EN** - Please follow the instruction manuals and use a pad to avoid damage during assembly.
- DE** - Bitte folgen Sie der Anleitung und verwenden Sie eine Unterlage, um Beschädigungen bei der Montage zu vermeiden.
- ES** - Por favor, siga las instrucciones del manual y utilice una cubierta o lona para proteger el producto y el suelo durante la instalación.
- FR** - Suivez les instructions de la notice et utilisez une couverture ou une bâche pour protéger le produit et les sols pendant le montage.
- IT** - Si prega di consultare il manuale illustrativo durante il montaggio e di utilizzare un cuscinetto per evitare possibili danni.



<p>① × 1</p> 	<p>② × 2</p> 	<p>③ × 1</p> 	
<p>④ × 1</p> 	<p>⑤ × 1</p> 	<p>⑥ × 1</p> 	
<p>⑦ × 1</p> 	<p>⑧ × 1</p> 	<p>⑨ × 1</p> 	
<p>⑩ × 2</p> 	<p>⑪ × 2</p> 	<p>⑫ × 2</p> 	<p>⑬ × 4</p> 
<p>Ⓐ × 1</p> 	<p>Ⓑ × 8</p> 	<p>Ⓒ × 12</p> 	<p>Ⓓ × 8</p> 
<p>Ⓔ × 24</p> 	<p>Ⓕ × 24</p> 	<p>Ⓖ × 24</p> 	<p>Ⓗ × 12</p> 







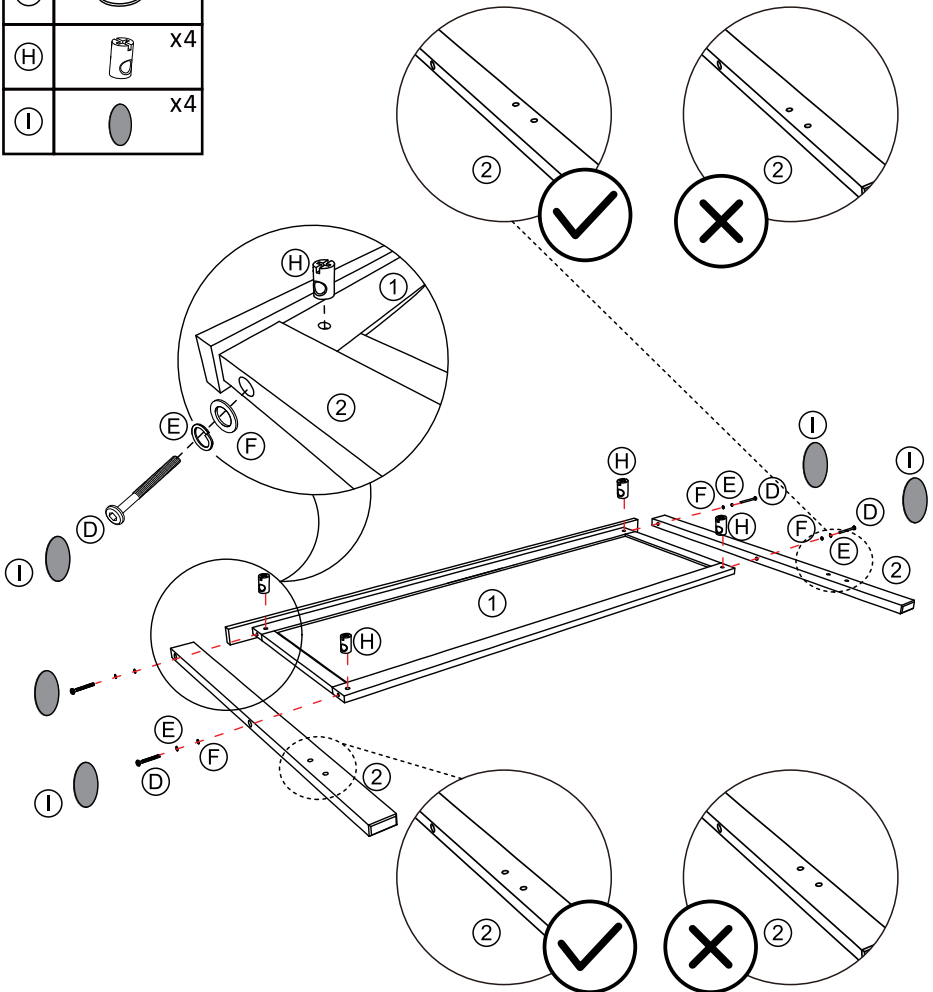

1

①		x1
②		x2
Ⓓ		x4
Ⓔ		x4
Ⓕ		x4
Ⓗ		x4
Ⓘ		x4

EN - Please pay attention to the direction of Part (2) when installing.
DE - Bitte bei der Montage die Richtung von Teil (2) beachten.
ES - Por favor preste atención a la dirección de la pieza (2) al instalar.
FR - Veuillez à bien respecter l'orientation de l'élément (2) lors du montage.
IT - Si prega di fare attenzione al verso della parte (2) durante il montaggio.







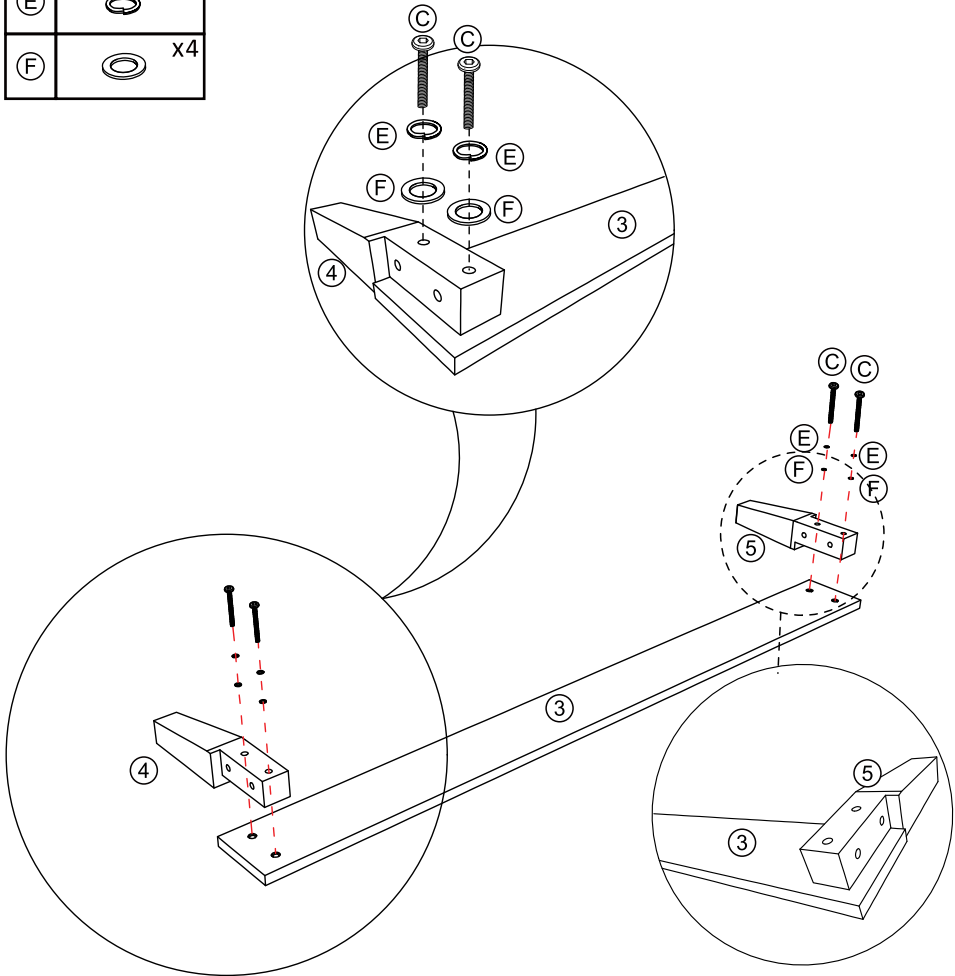

2

③		x1
④		x1
⑤		x1
Ⓒ		x4
Ⓔ		x4
Ⓕ		x4

EN - Please pay attention to the direction of Part (4)&(5) when installing.
DE - Bitte bei der Montage die Richtung von Teil (4)&(5) beachten.
ES - Por favor preste atención a la dirección de la pieza (4)&(5) al instalar.
FR - Veuillez à bien respecter l'orientation de l'élément (4)&(5) lors du montage.
IT - Si prega di fare attenzione al verso della parte (4)&(5) durante il montaggio.







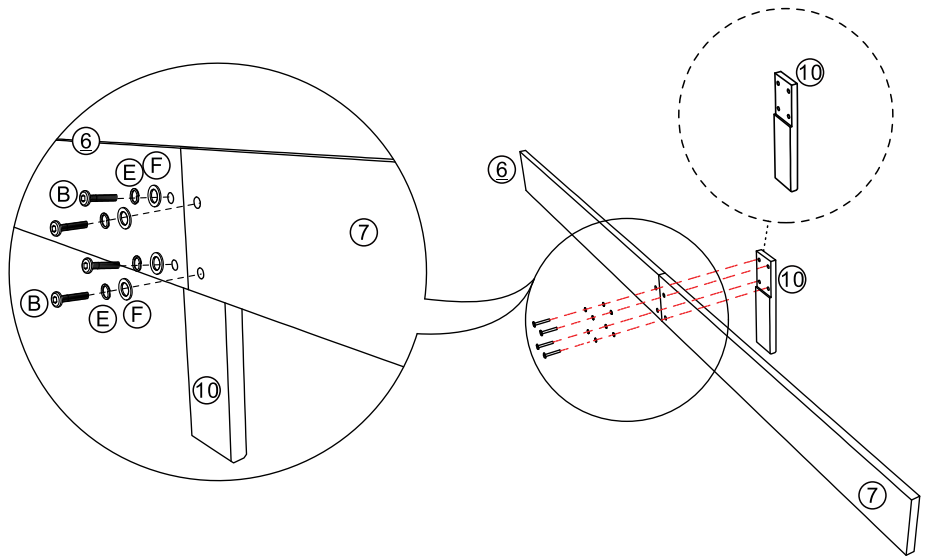
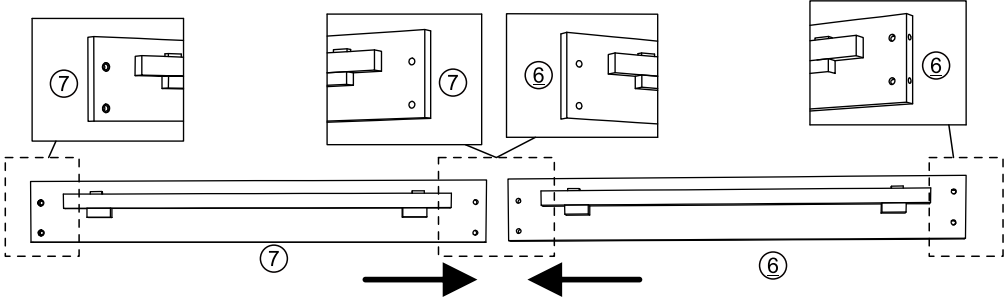

3

⑥		x1
⑦		x1
⑩		x1
Ⓑ		x4
Ⓔ		x4
Ⓕ		x4

EN - Please pay attention to the direction of Part (6)&(7) when installing.
DE - Bitte bei der Montage die Richtung von Teil (6)&(7) beachten.
ES - Por favor preste atención a la dirección de la pieza (6)&(7) al instalar.
FR - Veuillez à bien respecter l'orientation de l'élément (6)&(7) lors du montage.
IT - Si prega di fare attenzione al verso della parte (6)&(7) durante il montaggio.





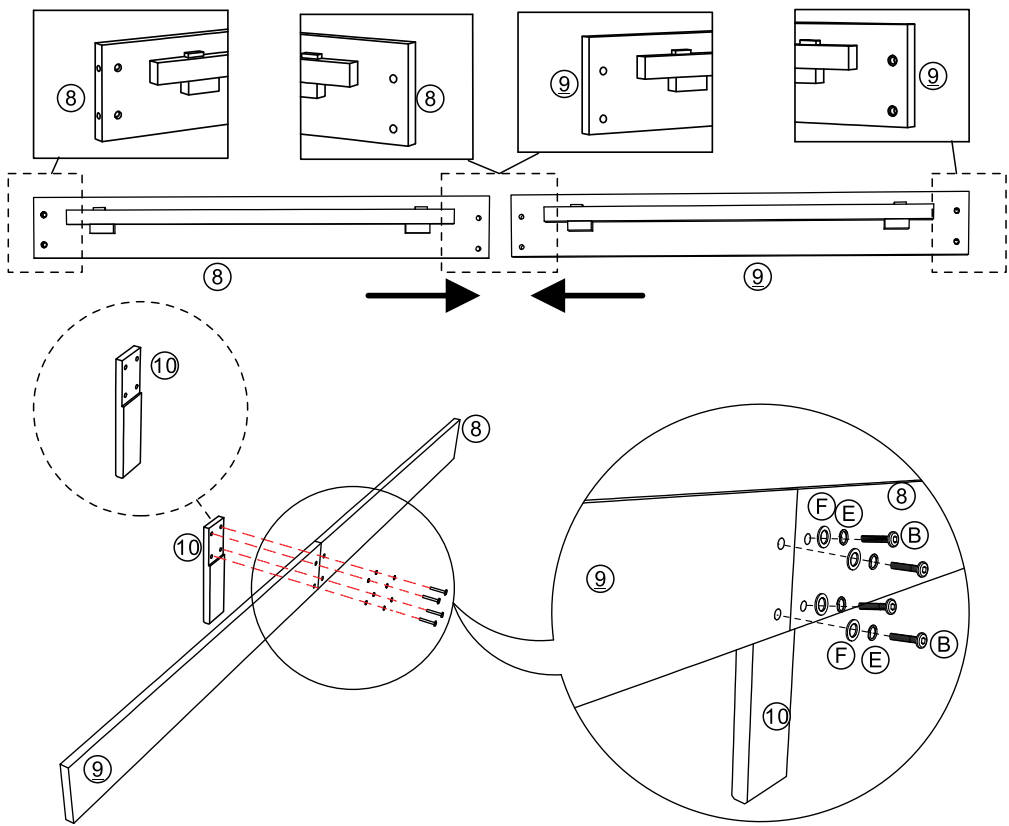

4

(8)		x1
(9)		x1
(10)		x1
(B)		x4
(E)		x4
(F)		x4

EN - Please pay attention to the direction of Part (8)&(9) when installing.
DE - Bitte bei der Montage die Richtung von Teil (8)&(9) beachten.
ES - Por favor preste atención a la dirección de la pieza (8)&(9) al instalar.
FR - Veuillez à bien respecter l'orientation de l'élément (8)&(9) lors du montage.
IT - Si prega di fare attenzione al verso della parte (8)&(9) durante il montaggio.





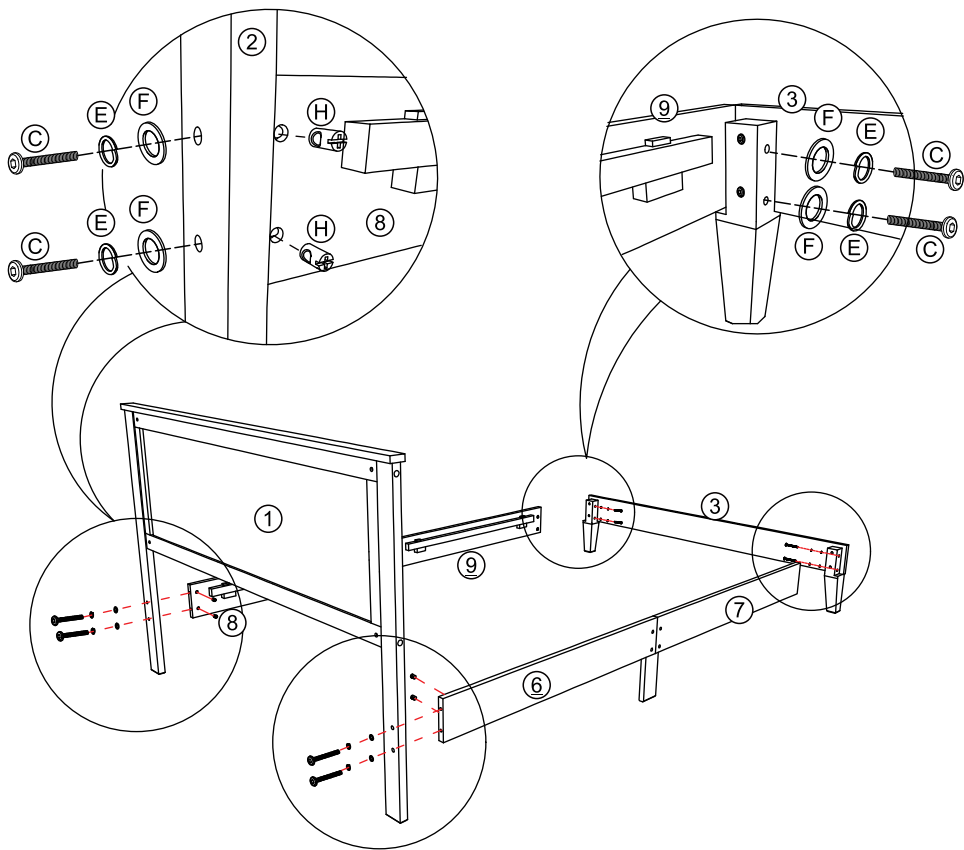
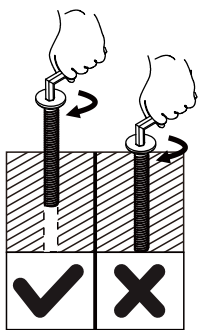

5

(C)		x8
(E)		x8
(F)		x8
(H)		x4

 EN - Assembly requires 2 adults.
 DE - Die Montage erfordert 2 Erwachsene.
 ES - Para el montaje se necesitan 2 adultos.
 FR - L'assemblage nécessite 2 adultes.
 IT - Il montaggio richiede 2 adulti.



6

⑪		x1
⑫		x1
⑬		x2
Ⓓ		x2
Ⓗ		x2

 **EN** - Assembly requires 2 adults.
DE - Die Montage erfordert 2 Erwachsene.
ES - Para el montaje se necesitan 2 adultos.
FR - L'assemblage nécessite 2 adultes.
IT - Il montaggio richiede 2 adulti.

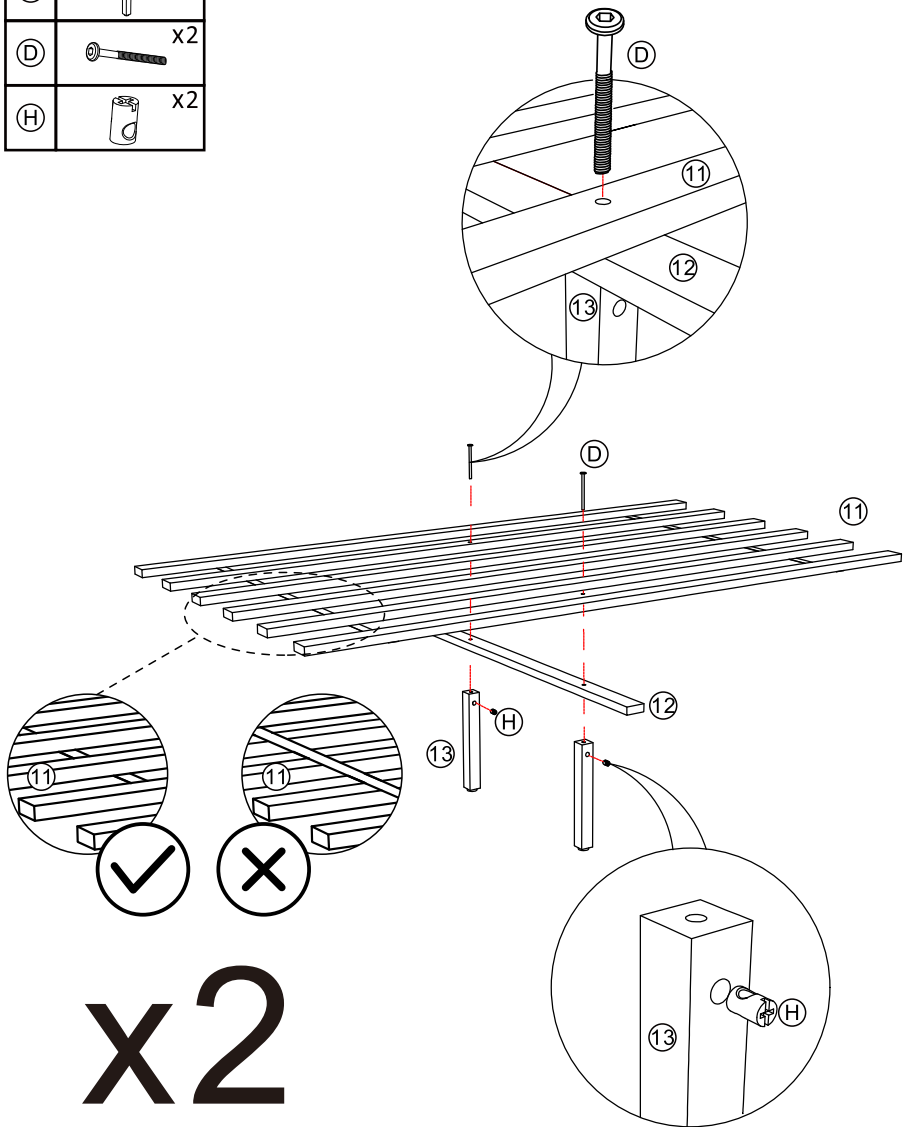

7

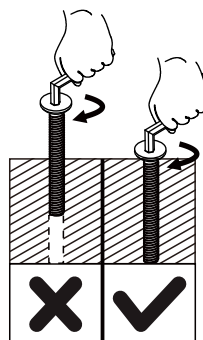
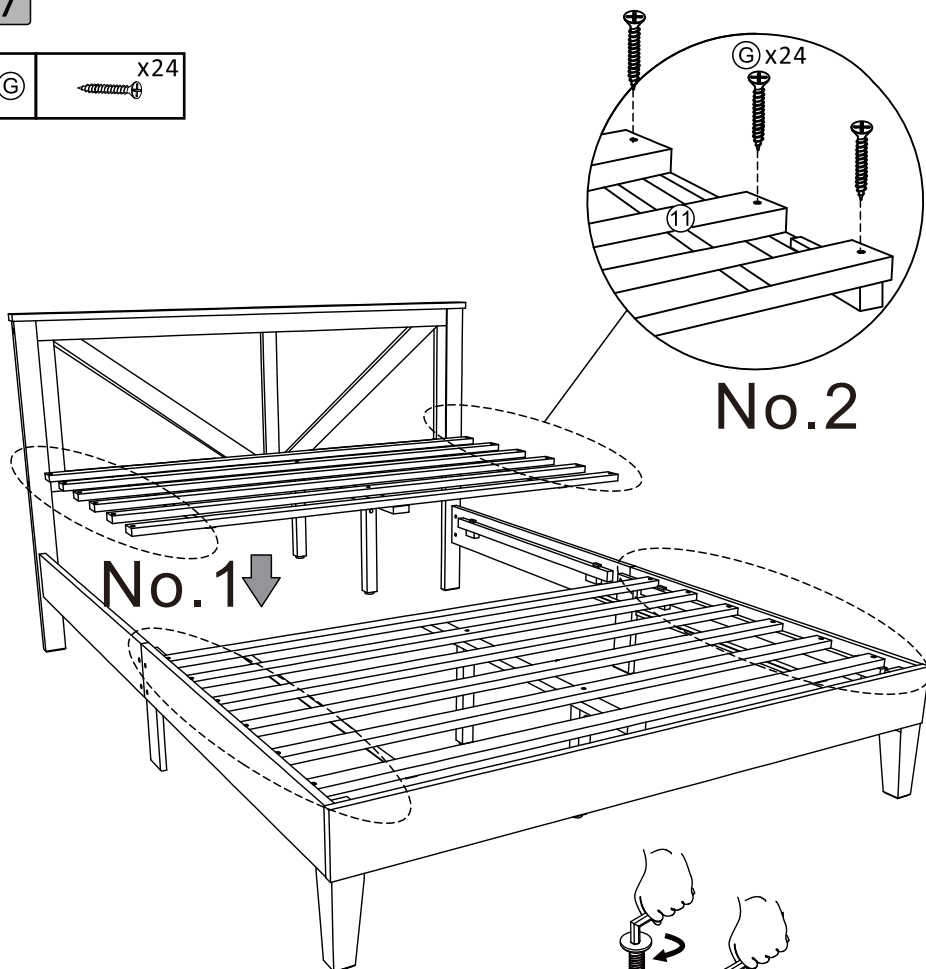

EN - Note: Tighten all screws completely after assembly.

DE - Hinweis: Ziehen Sie nach der Montage alle Schrauben vollständig an.

ES - Nota: Apretar completamente todos los tornillos después de montar.

FR - NB : Serrez les vis complètement après l'assemblage.

IT - Nota: Stringere completamente tutte le viti solo dopo l'assemblaggio.

EN - You can also download the electronic Installation Manual from the Product guides and documents section of the advertising page.

DE - Das elektronische Installationshandbuch können Sie auch im Bereich Produktführungen und Dokumente der Werbeseite herunterladen.

ES - También puede descargar el Manual de instalación electrónica de la Guía del producto y la Sección de documentación de la página de anuncios.

FR - Vous pouvez également télécharger le manuel d'installation électronique à partir de la section Guide produit et documentation de la page publicitaire.

IT - È inoltre possibile scaricare il manuale di installazione elettronico dalla guida del prodotto e dai documenti nella pagina pubblicitaria.