

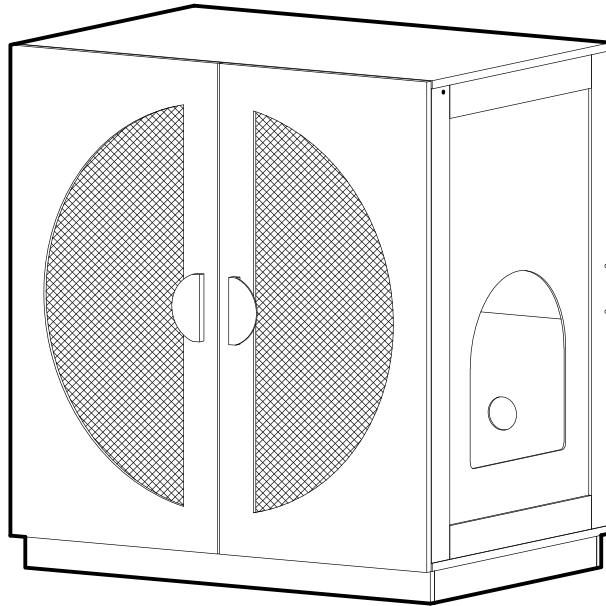

Cat Litter Box Enclosure, Grey Assembly Instructions



Universe Home Inc.

If you have any issues with the product,
please contact us.

 : +1 (877) 313 6212
(Mon–Fri, 8:00 am – 5:00 pm PT)

 : info@universeh.com (24/7)

 : unipawspro.com



Scan to submit a request
We'll reply within 1 business day

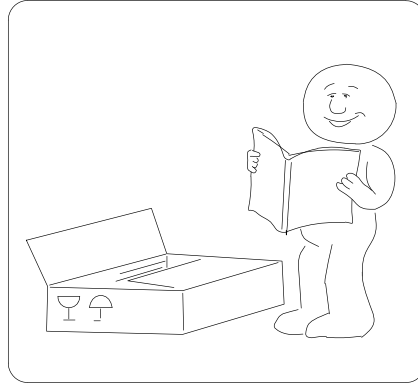
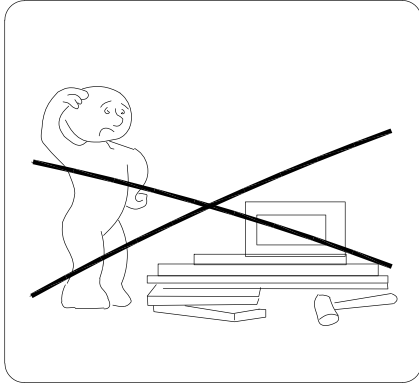

! WARNING !

1. PLEASE READ ALL INSTRUCTIONS CAREFULLY BEFORE STARTING ASSEMBLY.
2. DO NOT LET ANY SHARP OBJECTS TOUCH OR RUB THE SURFACE OF THE PRODUCT.
3. WHEN ASSEMBLING, DO NOT LET CHILDREN PLAY AROUND THE WORKING AREA.
4. PLEASE CONFIRM ALL PARTS ARE CORRECT BEFORE STARTING THE ASSEMBLY PROCESS.
5. DO NOT TIGHTEN ALL BOLTS AND SCREWS COMPLETELY UNTIL THE ENTIRE UNIT HAS BEEN ASSEMBLED AND SET UP.

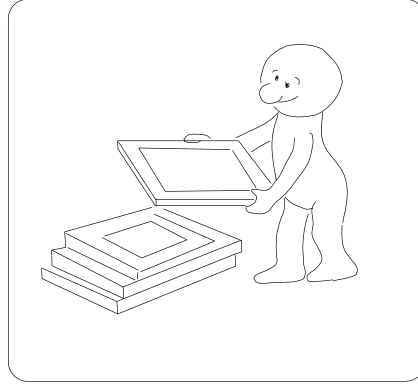
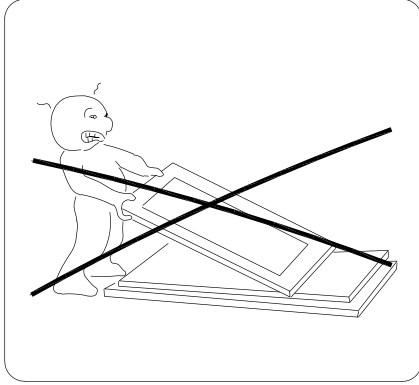

ADVISE

1. DO NOT SIT OR STAND ON THIS PRODUCT. IT IS INTENDED FOR PETS ONLY.
2. THIS PRODUCT SHOULD BE ASSEMBLED BY AN ADULT.
3. PLEASE PUT THE PRODUCT ON A SMOOTH SURFACE AFTER YOU ASSEMBLED IT.
4. PLACE ALL PARTS ON A CLEAN AND SMOOTH SURFACE SUCH AS A RUG OR CARPET TO AVOID THE PARTS FROM BEING SCRATCHED.
5. THE SCREW OF HINGE ON THE DOOR ALSO CAN BE ADJUSTABLE, TO MAKE IT EVEN THEN TIGHTEN ALL SCREWS.

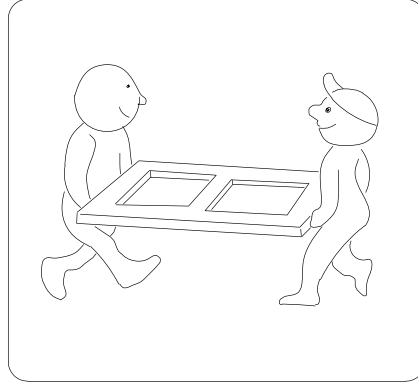
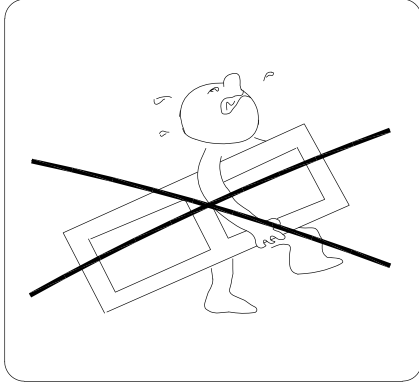

TOOL NEEDED

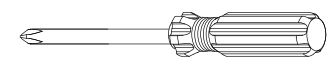

SCREWDRIVER REQUIRED
- NOT INCLUDED

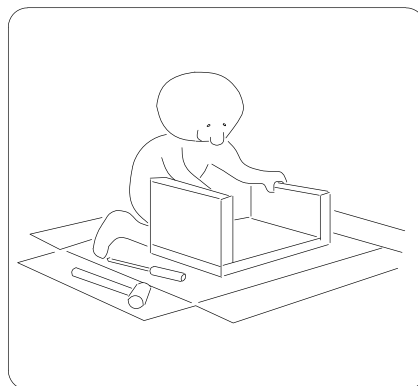
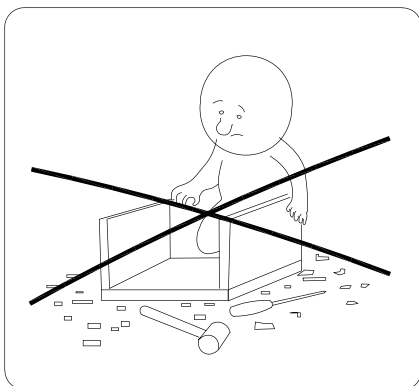
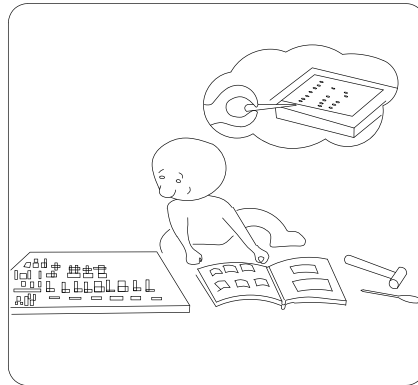
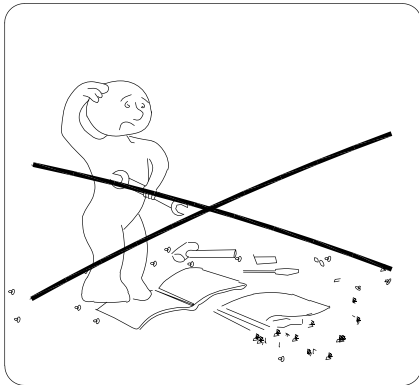

PARTS

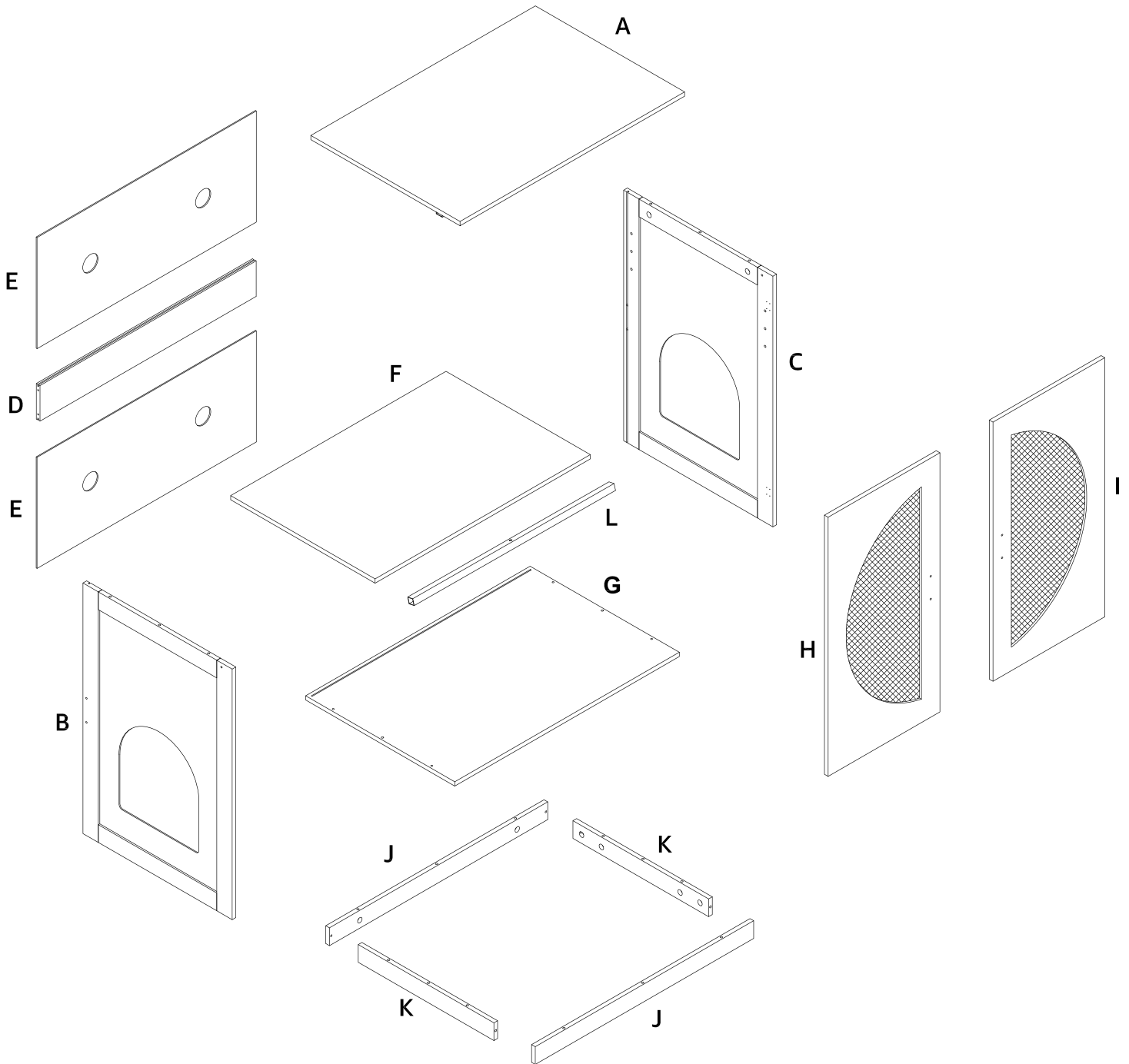

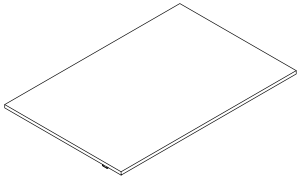

A
Top Panel
x1

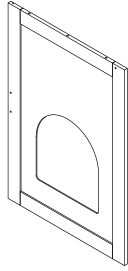

B
Side Panel
x1

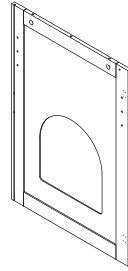

C
Side Panel
x1

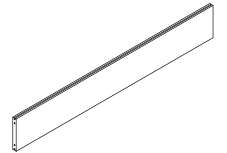

D
Back Bar
x1

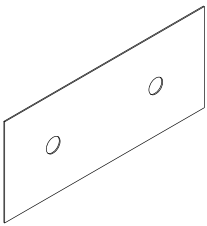

E
Rear Support Panel
x2

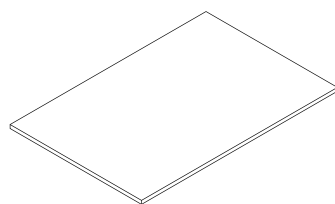

F
Inner Divider Panel
x1

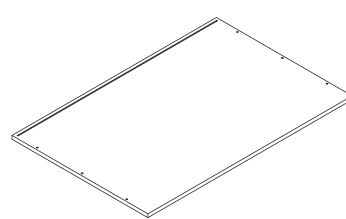

G
Bottom Panel
x1

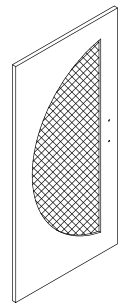

H
Left Door
x1

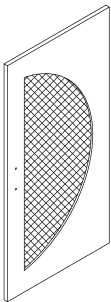

I
Right Door
x1

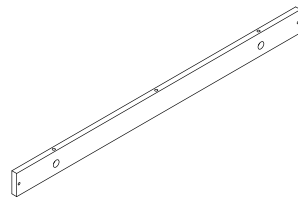

J
**Long Bottom Panel
Of Feet**
x2

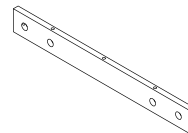



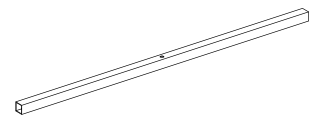











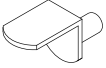

K
**Short Bottom Panel
Of Feet**
x2









L
Top Bar
x1

HARDWARE

- | | | | | | | | | |
|---|---|---|---|---|--|---|---|---|
|  |  |  |  |  |  |  |  |  |
| 1 | 2 | 3 | 4 | 5 | 6 | 7 | 8 | 9 |
| x 16 pcs | x 16 pcs | x 8 pcs | x 3 pcs | x 24 pcs | x 8 pcs | x 4 pcs | x 4 pcs | x 8 pcs |
|  |  |  |  |  |  |  |  |  |
| 10 | 11 | 12 | 13 | 14 | 15 | 16 | 17 | 18 |
| x 8 pcs | x 2 pcs | x 4 pcs | x 2 pcs | x 2 pcs | x 2 pcs | x 2 pcs | x 1 pc | x 2 pcs |

ASSEMBLY INSTRUCTIONS

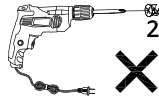
1 Connect top bar L to top panel A with screw 4, Install 4pcs of pin 1 and 2pcs of wooden dowel 3 in the holes correspondingly. Install the panel C and B on the two sides and using 4pcs of bolt 2, screw 4 for tightening.

						
1	2	3	4	17	NO!	YES!
x 4 pcs	x 4 pcs	x 2 pcs	x 3 pcs	x 1 pc		

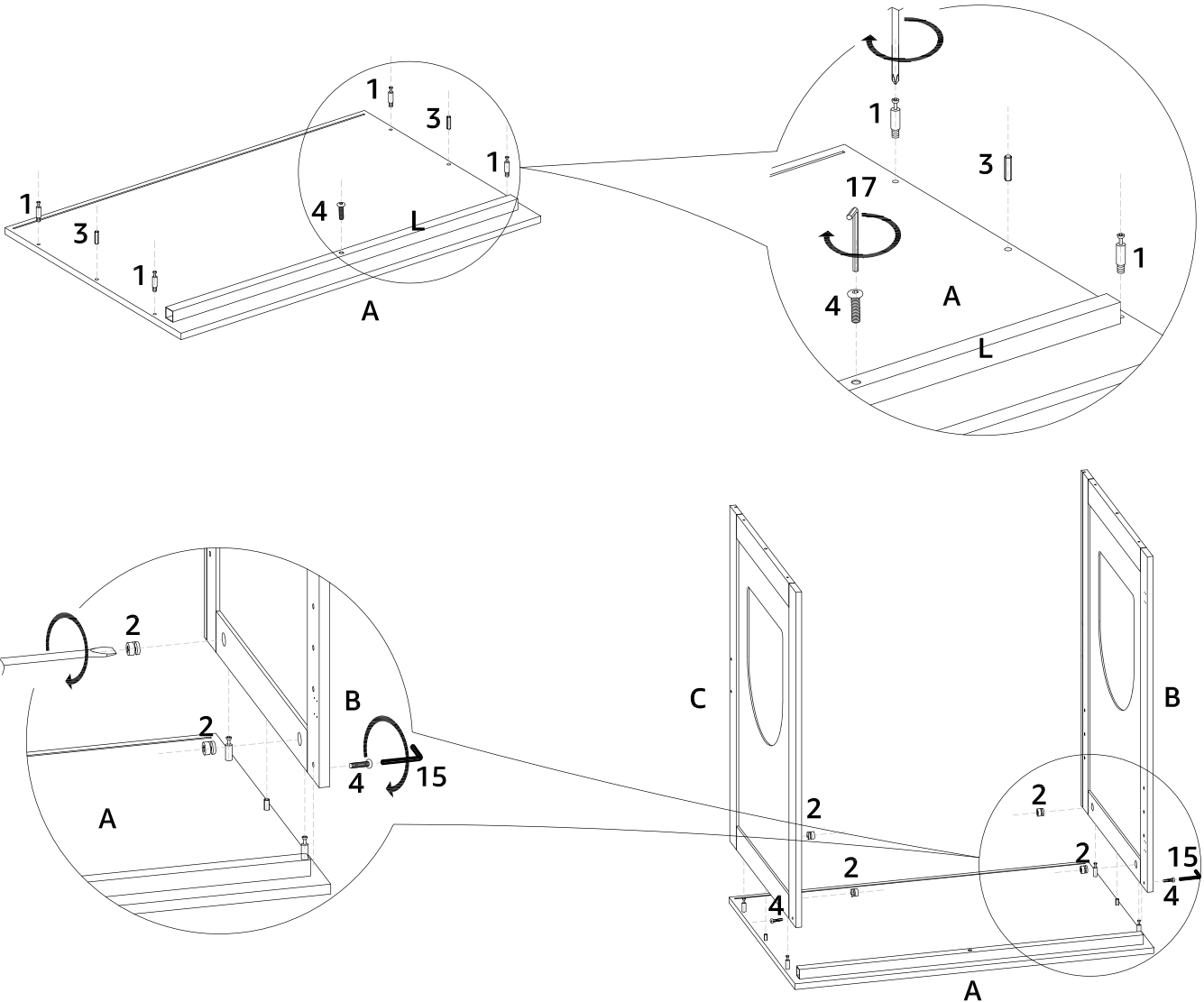

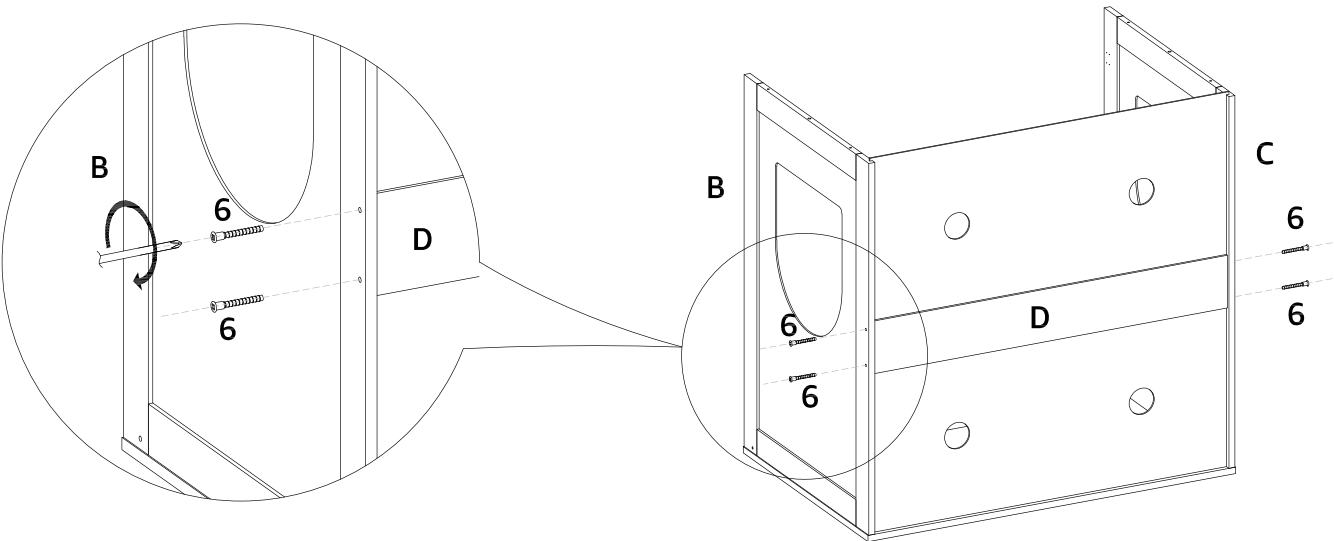
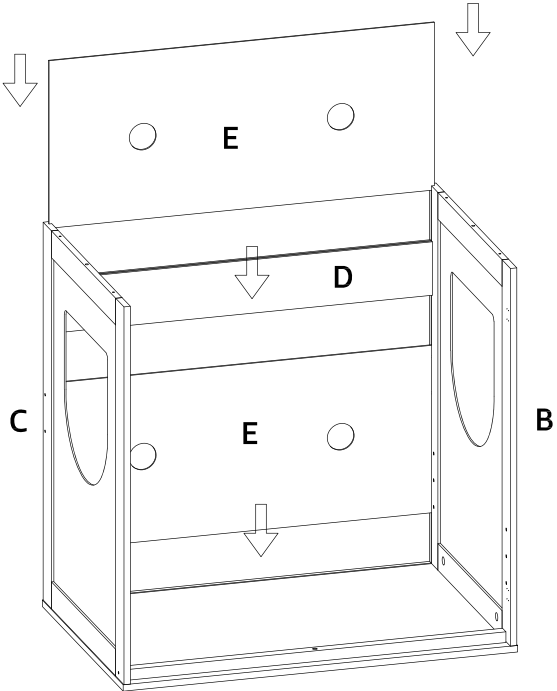
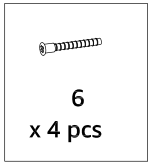

2 Install Back Bar D among panel C, B and put two pieces of Rear Support Panels E in With screw 6 tightened by Allen Wrench.



3





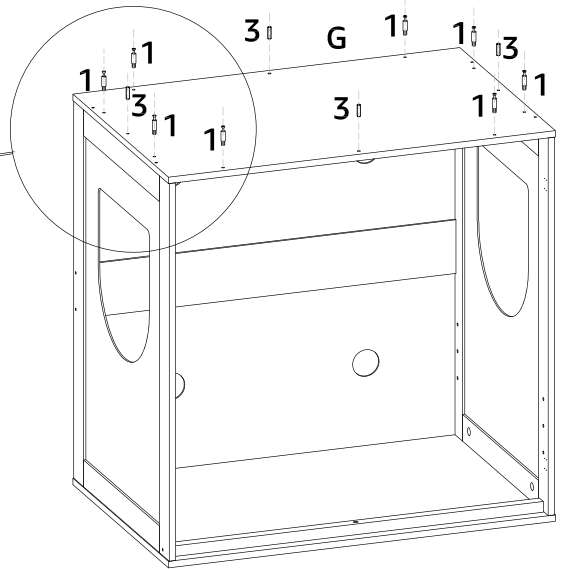
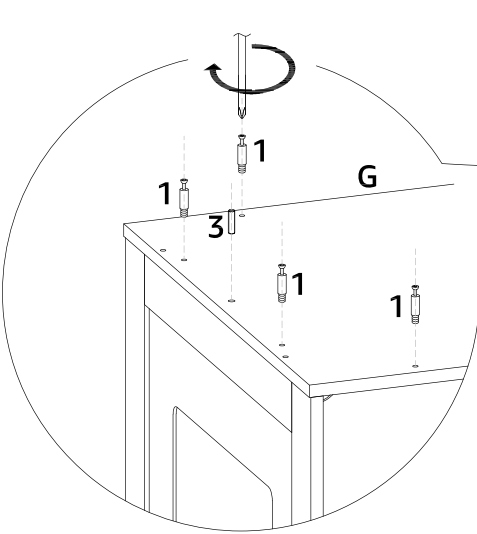
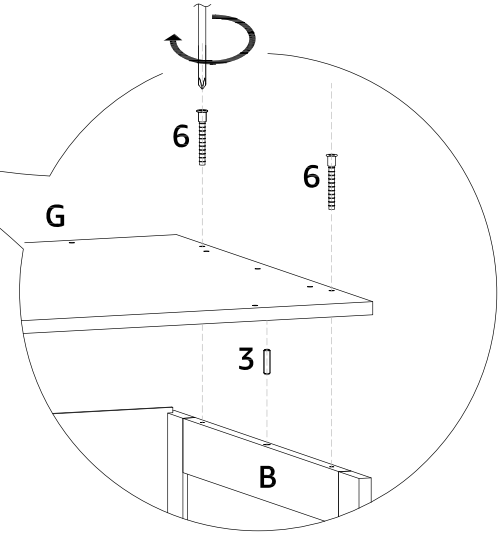
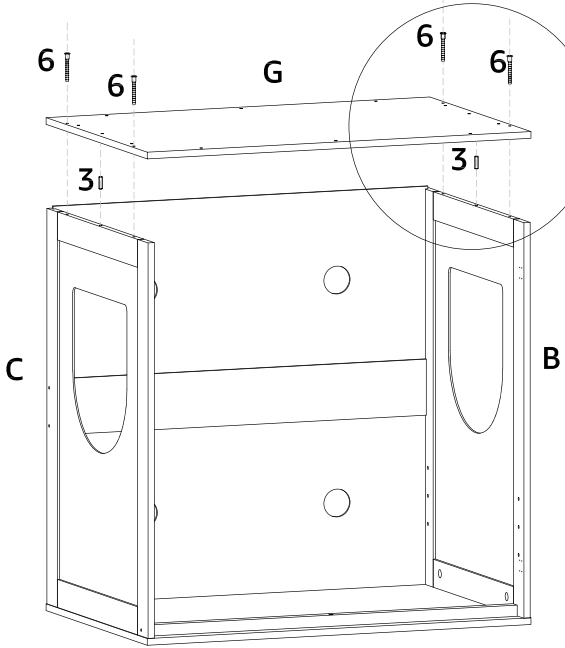

Connect the bottom panel G to panels C, B, E with screw 6 and wooden dowel 3. Install 8pcs of pin 1 and 4pcs of wooden dowel 3 into the holes of panel G correspondingly.

 1 x 8 pcs	 3 x 6 pcs	 6 x 4 pcs
---	---	---



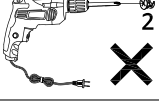

4

Secure pin 1 into the long bottom panel of feet J on both sides.
Assemble the bottom panel of feet J and K with screw 2 tightened.
Lock the assembled bottom frame with bolt 2 securely to the bottom panel G.

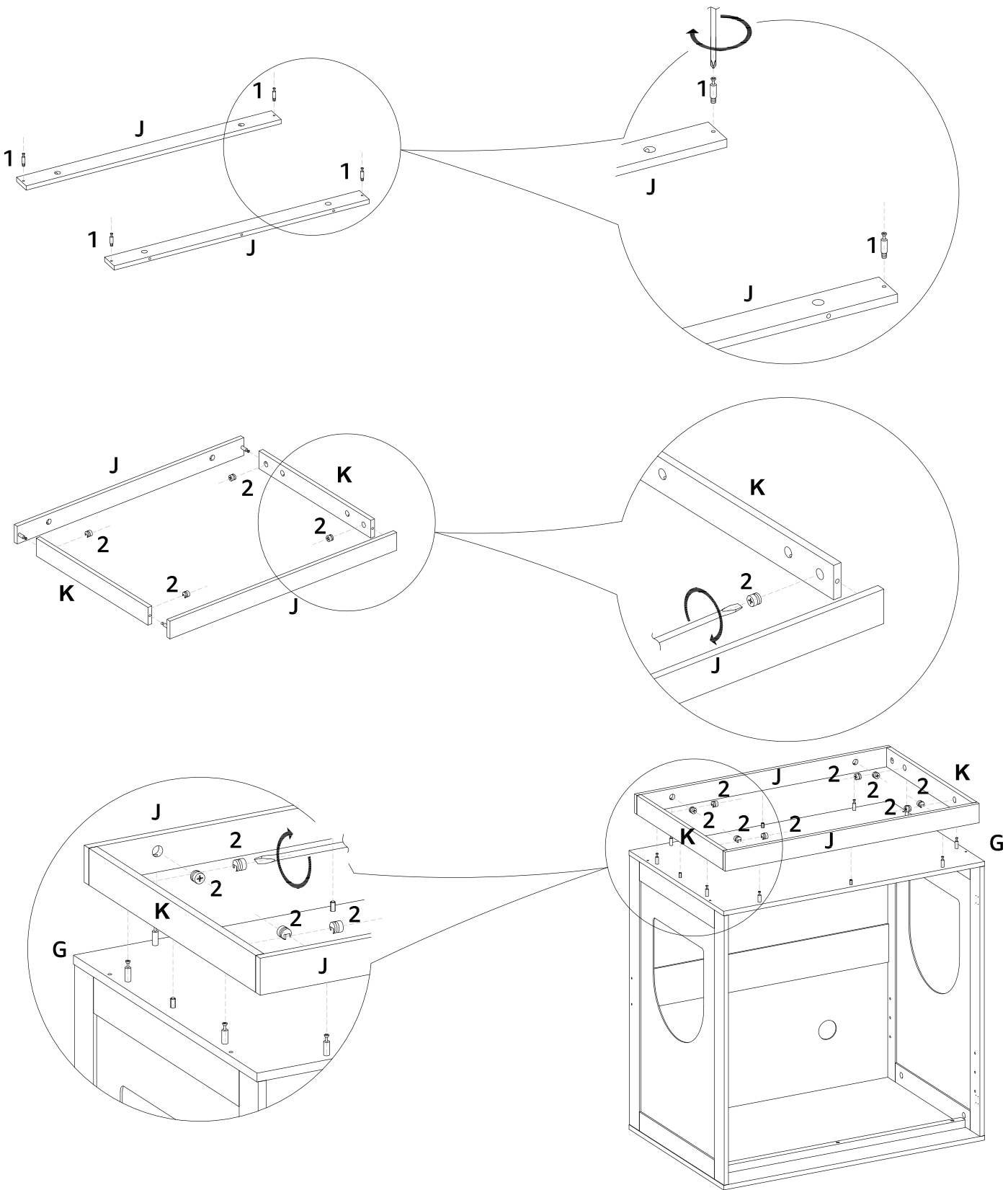
 1 x 4 pcs	 2 x 12 pcs	 	 
		NO!	YES!



5 Fixing the hinges 7 on the two side panels H, I with screw 5.
Stick mute pads 18 on the inner sides of the two doors.

		
5 x 24 pcs	7 x 4 pcs	18 x 2 pcs

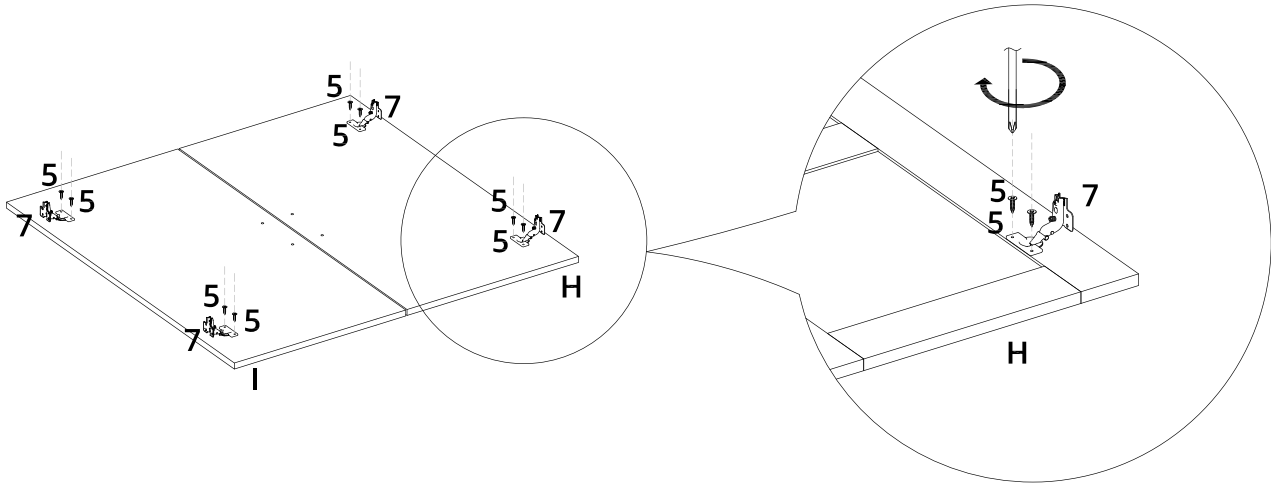

! Note: After door installation, please adjust the hinges if you notice that the door gap is too wide or too narrow. To narrow the gap, simply turn the screws clockwise to drive them inwards. Conversely, to widen the gap, turn the screws counterclockwise to draw them outwards. If you're still unsure about the adjustment process, please refer to the YouTube video link below: https://youtu.be/HjbOAZyE_s

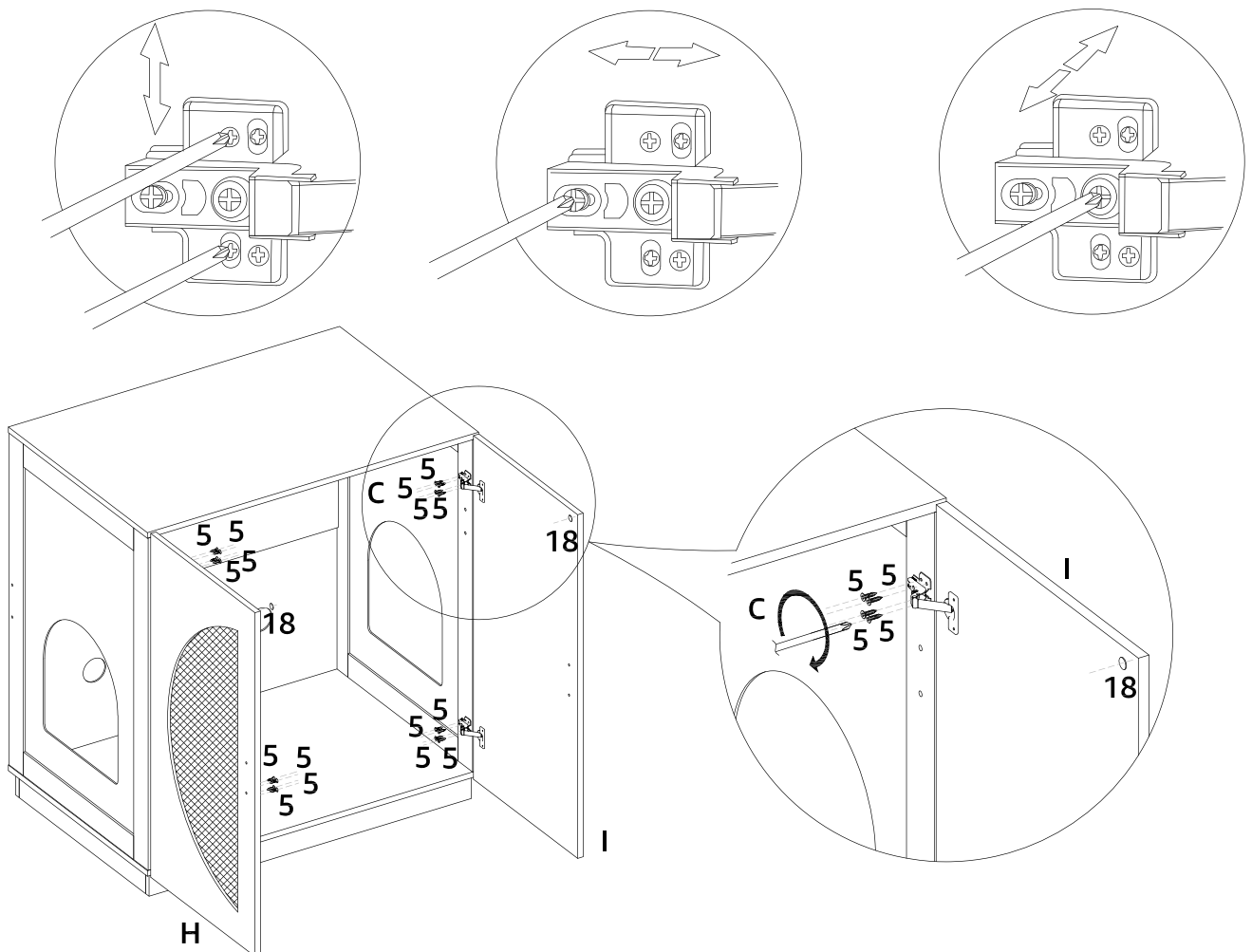



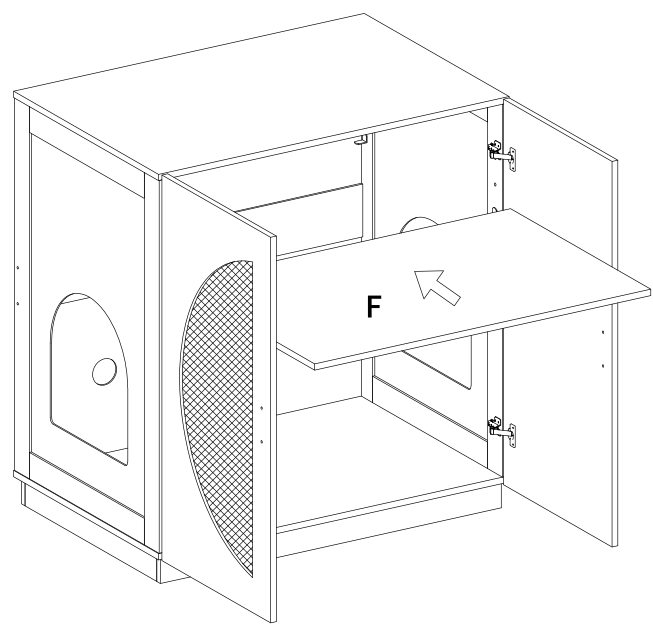
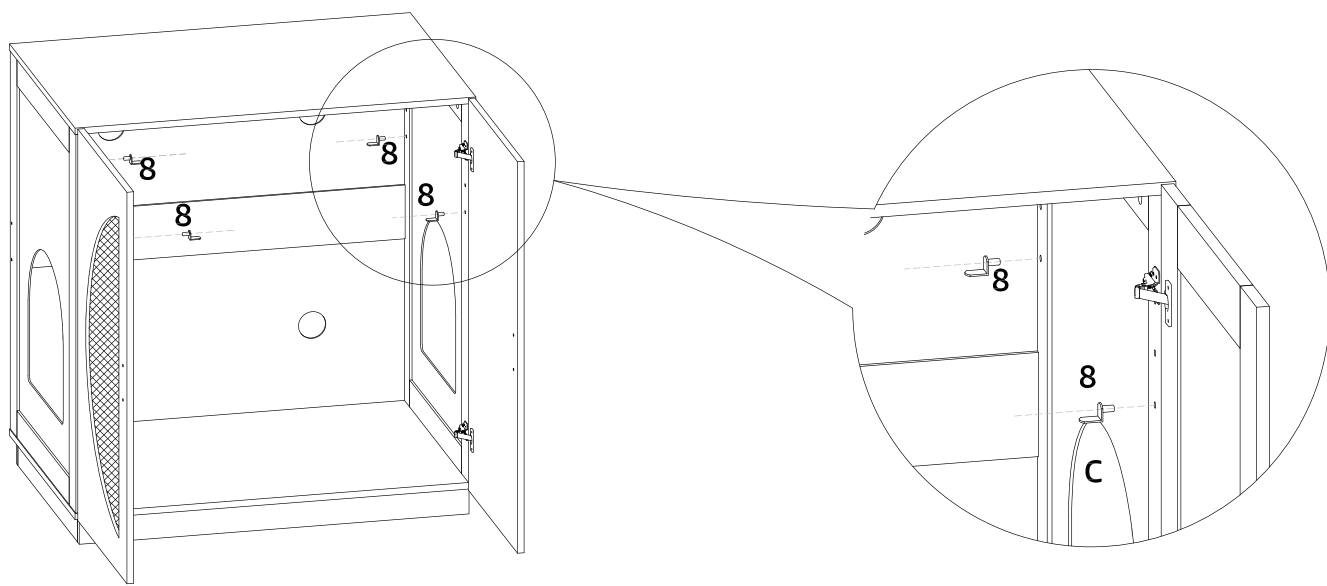
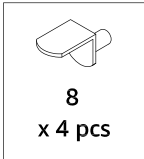

6

Insert the part 8 into the inner wall of the side panel B, C.
Connect the two sides of the panel H,I to the panels B, C with hinge and using screw 5 tightened.
Install the Inner Divider Panel F into the cabinet.





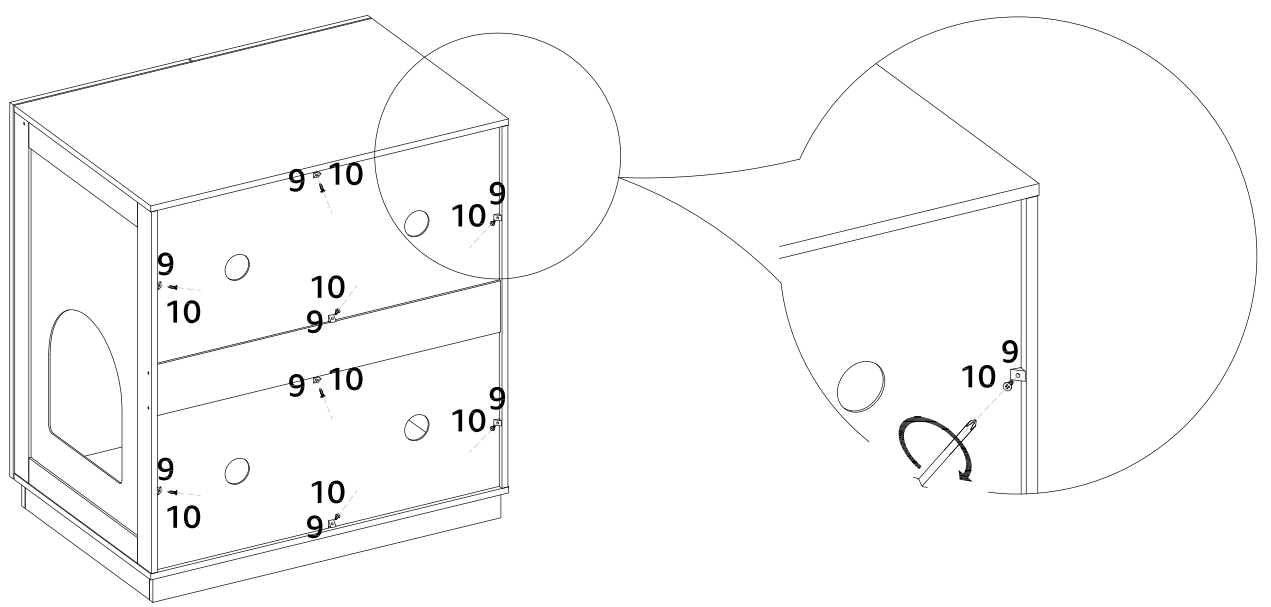
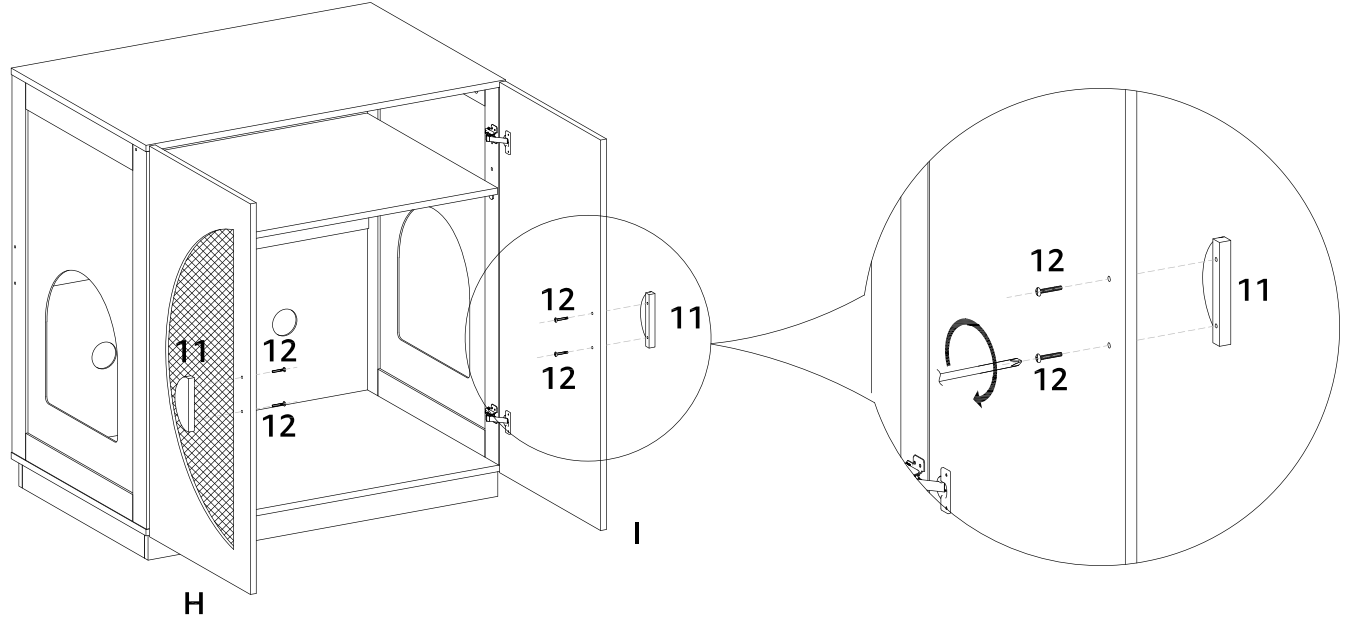

7

Secure the doorknobs 11 on the side of panel H, I.
Insert the part 9 into the specified location on the back of cabinet and using screw 10 tightened.
Then the assembly has been completed.

			
11 x 2 pcs	12 x 4 pcs	9 x 8 pcs	10 x 8 pcs



For safety use, you can secure the cabinet where you want it to be on the wall.

			
13 x 2 pcs	14 x 2 pcs	15 x 2 pcs	16 x 2 pcs

