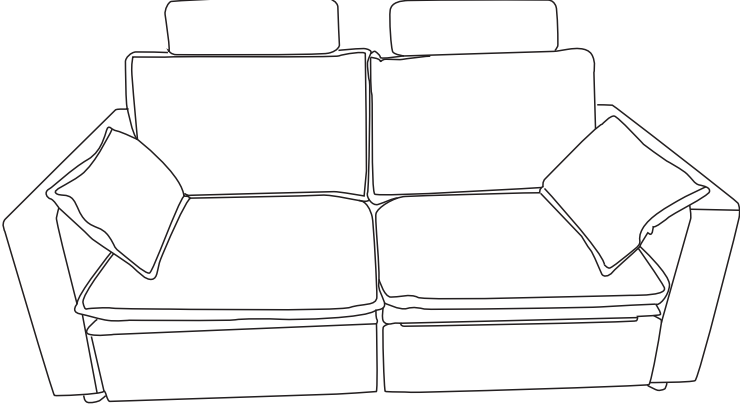
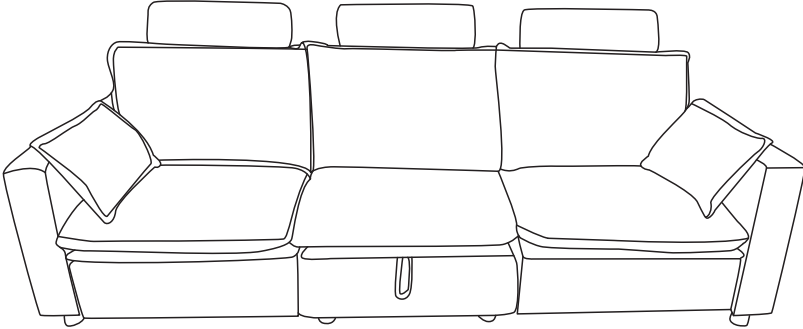

Recliner Sofa

Model	Description
<p>2 Seat Power Recliner Sofa 3 BOX(A/B/C)</p> <p>Refer to pages 1-12 of the manual for complete details</p>	
<p>3 Seat Power Recliner Sofa 4 BOX(A/B/C/D)</p> <p>Refer to pages 12-22 of the manual for complete details</p>	

Safety Instructions

1. Check Components: Before starting, ensure all parts are included and undamaged.
2. Use Proper Tools: Use the tools provided in the package to avoid damaging components.
3. Maintain a Safe Distance: Keep a gap of at least 6-10 inches between the product and walls or other objects.
4. Power Safety: Always unplug the product before moving or cleaning it.

Note:



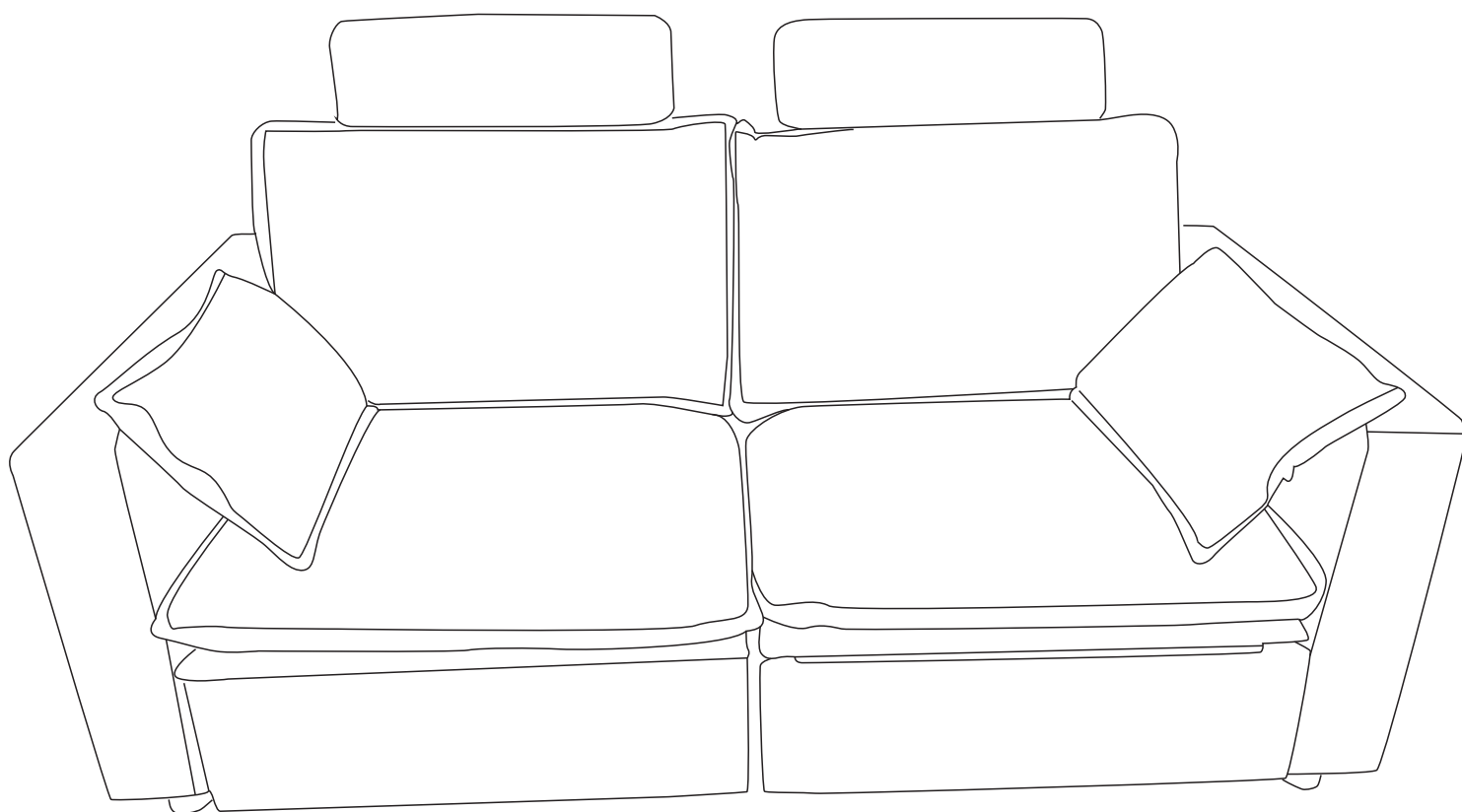

If you encounter any issues during assembly, please contact our customer service team and provide pictures for reference. We are here to assist you!

Electric 2-Seater Sofa



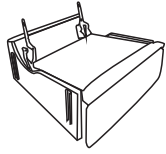

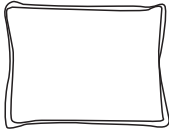
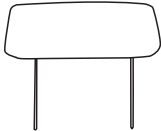

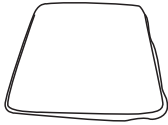
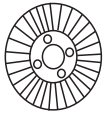
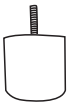
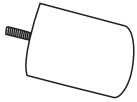
Installation instructions

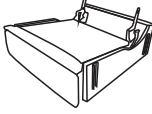
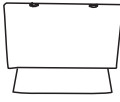
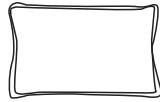
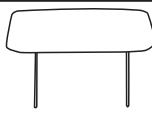

Parts Listing

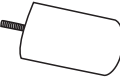
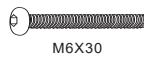
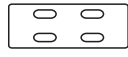

BOX-A			
NO.	DRAWING	QTY	DESCRIPTION
A		1	SEAT
B		1	BACK REST
C		1	BACKREST PADDING
D		1	PILLOW
E		1	PILLOW
F		1	SEAT PADDING
G		6	GASKETS
H		4	LEGS
I		2	LEGS

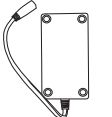
Parts Listing

BOX-B			
NO.	DRAWING	QTY	DESCRIPTION
A1		1	SEAT
B		1	BACKREST
C		1	BACKREST PADDING
D		1	PILLOW
E		1	PILLOW
F		1	SEAT PADDING
G		6	GASKETS
H		4	LEGS
I		2	LEGS
J	 M6X30	8	SCREW
K		2	CONNECTOR
L		1	ALLENKEY
M		1	POWER SOURCE

Parts Listing

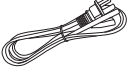
BOX-B

NO.	DRAWING	QTY	DESCRIPTION
N		1	CONNECTION WIRE
O		1	Y-CABLE

BOX-C

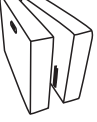
NO.	DRAWING	QTY	DESCRIPTION
P		2	ARM

Step 1

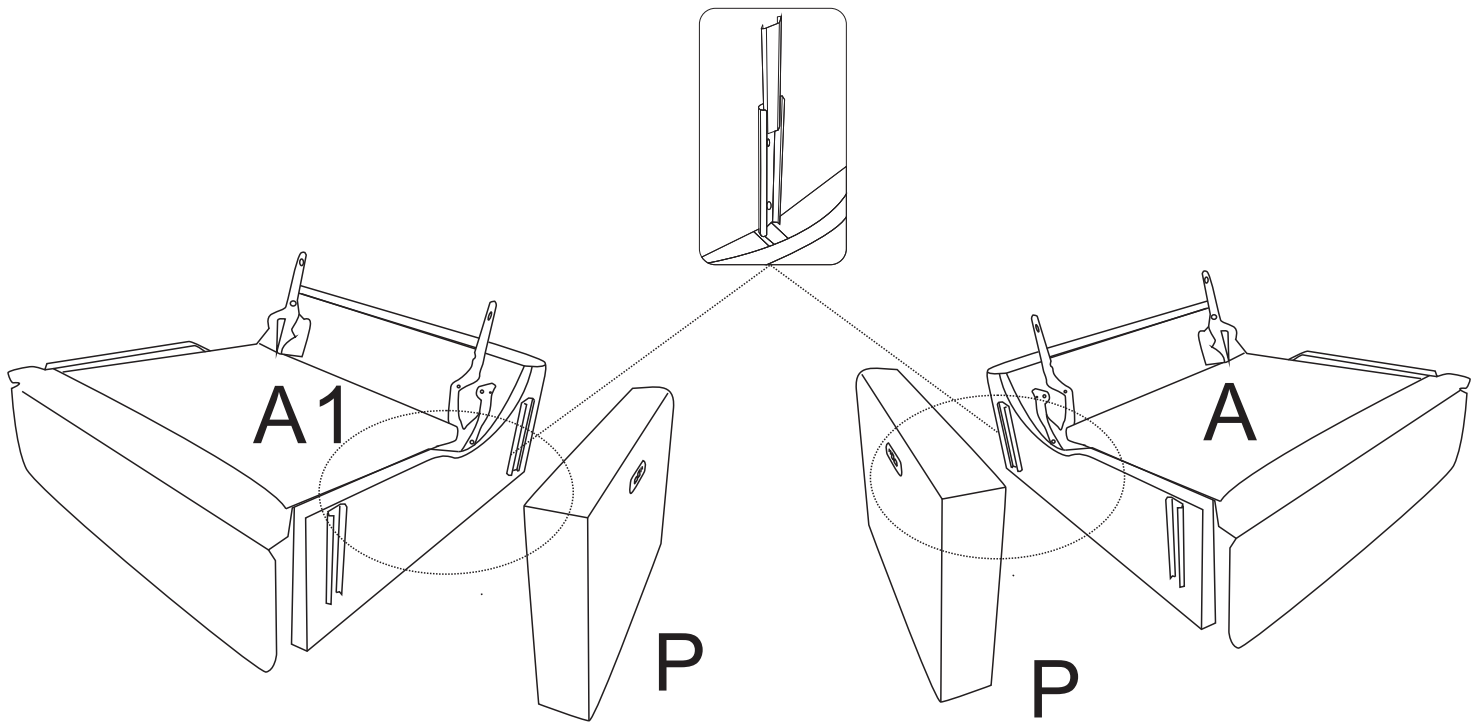

Attaching the Armrests

1. Locate the armrests (P) in BOX C.
2. Align each armrest (P) with the corresponding side of the seat (A/A1).

Step 2

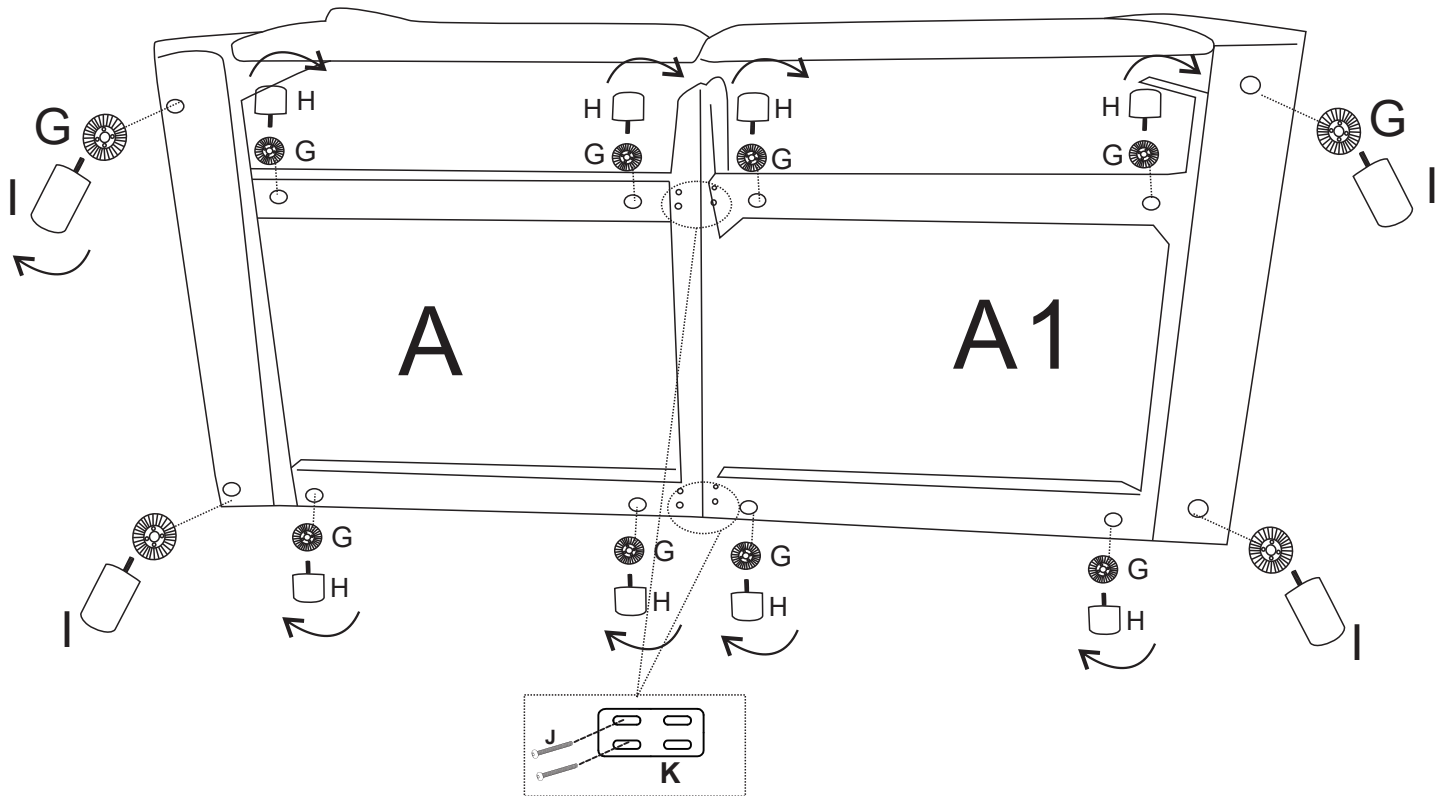

Connecting the Sofa & Installing the Legs

1. Connect the Seats: Use the provided M6X30 screws (J) and connecting plates (K) to join the two seats (A and A1) together.

Tighten the screws with the Allen Key (L).

2. Install the Legs:

- Attach the 4 long legs (I) to the bottom of the armrests (P) using the gaskets (G).

- Attach the 8 short legs (H) to the bottom of the seats (A and A1) using the gaskets (G).

Tip: Ensure the legs are properly aligned to avoid any difficulties during installation.

Step 3

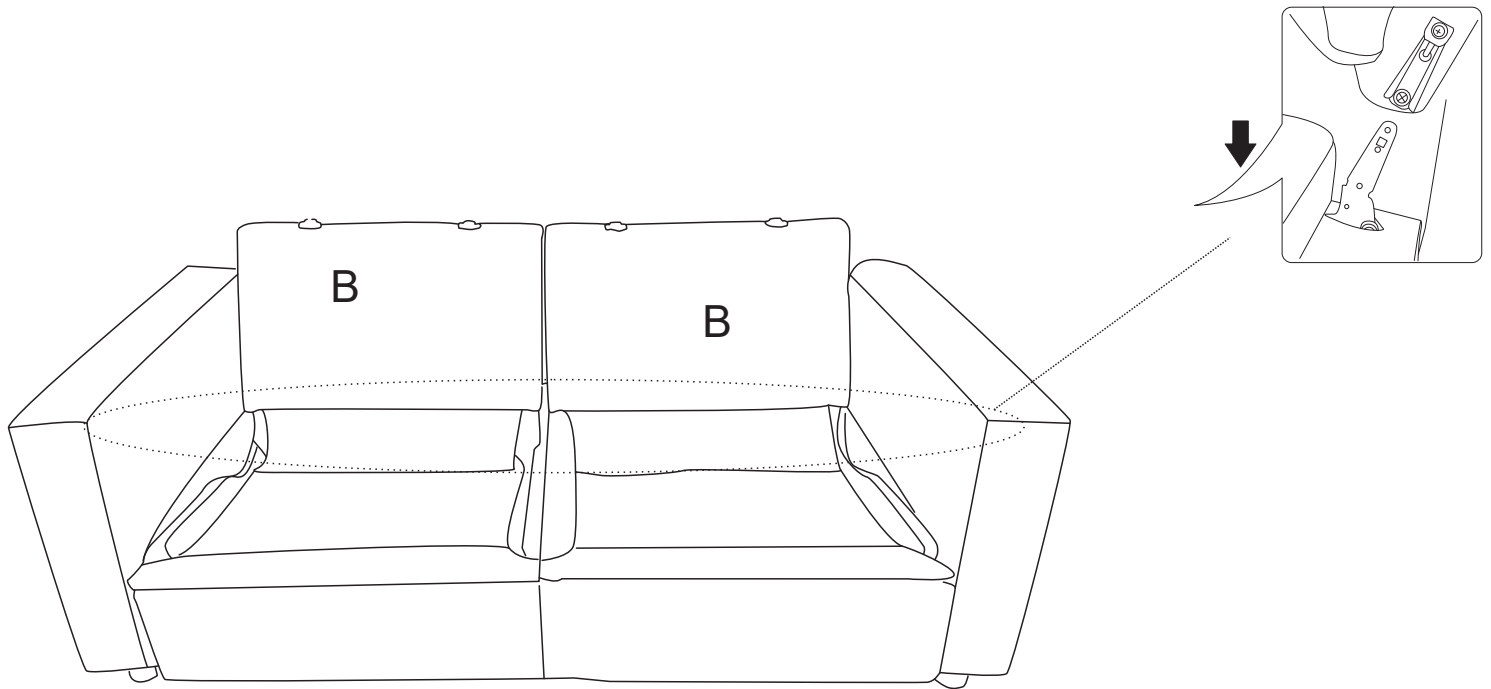

Connecting the Backrest

Attach the Backrest (B) to the Seat (A/A1) by aligning the connectors. Slide the backrest downwards until you hear a click, indicating it's securely attached.

Tip: Ensure that the backrest is properly aligned with the seat before sliding it into place.

Step 4

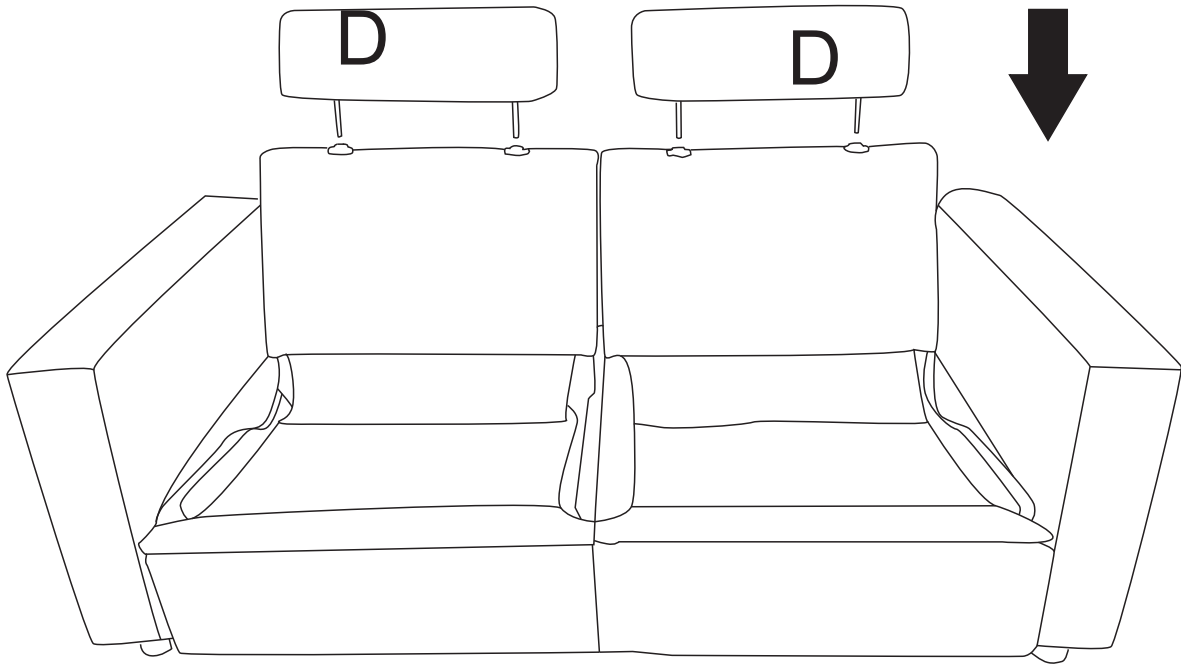

Installing the Headrest

Align the holes on the headrest (D) with the corresponding slots on the backrest (B). Once aligned, securely attach the headrest to the backrest by gently pressing it down until it clicks into place. Make sure the headrest is firmly installed before proceeding to the next step.

Step 5

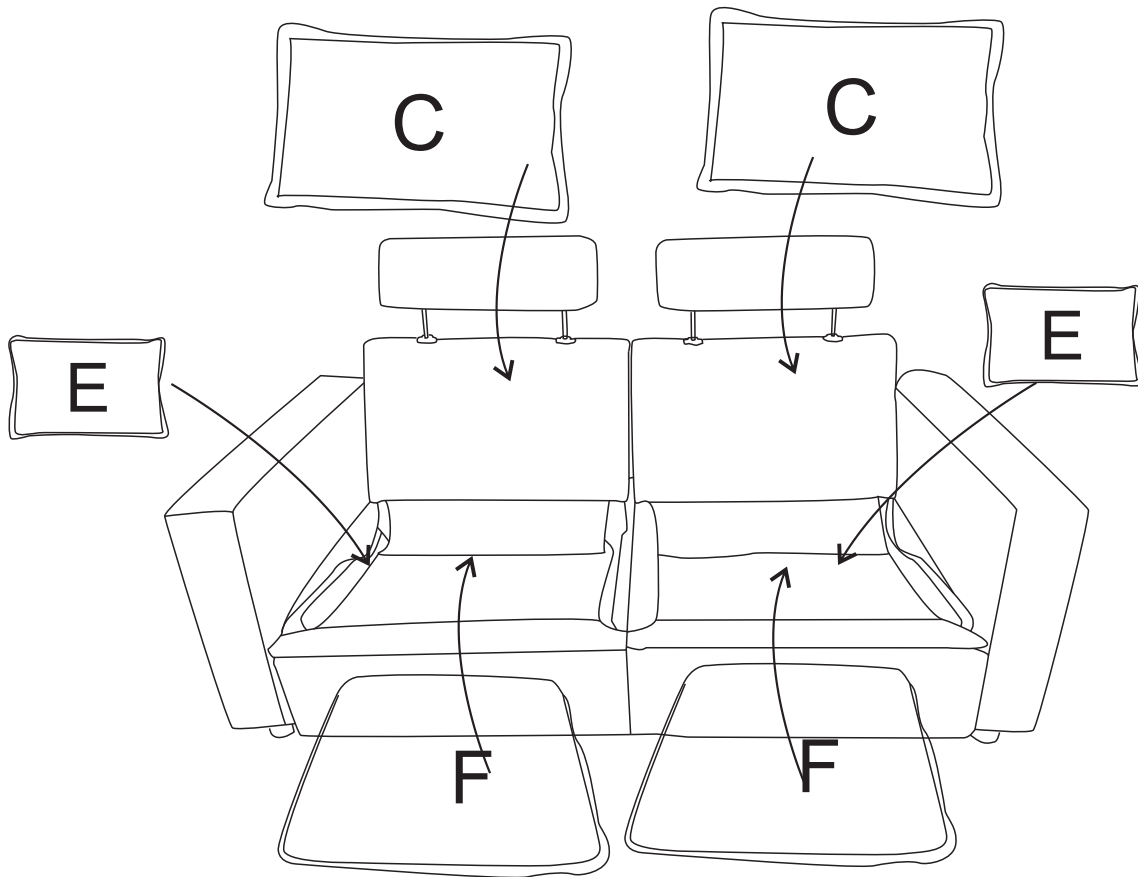

Arrange the Backrest, Cushion, and Pillows

1. Place the backrest (C) to the back of the chair as illustrated in the diagram.
2. Position the cushion (F) evenly on the seat.
3. Arrange the small pillows (E) to your liking.

Pro Tip: For a neat and polished appearance, smooth out any wrinkles in the fabric.

Step 6

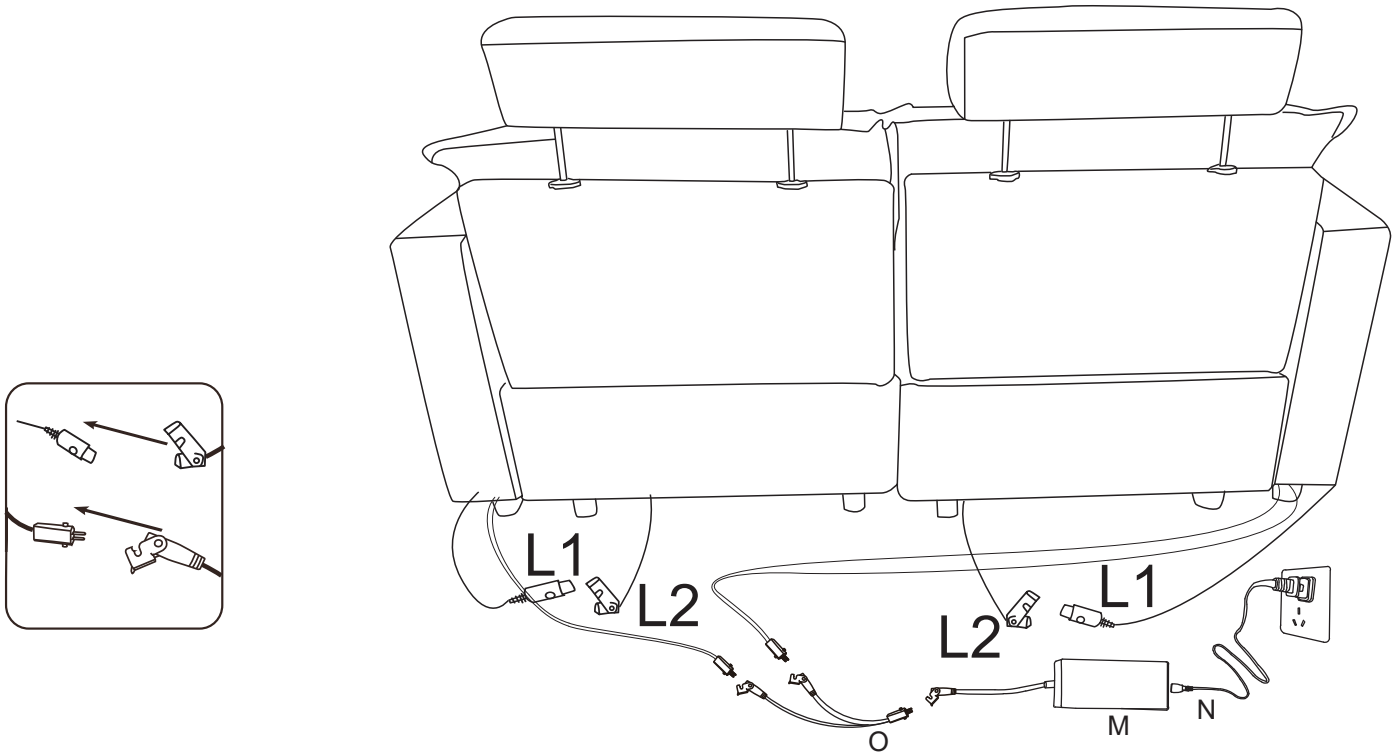

Connecting Power

1. Connecting the L1 and L2 lines behind the sofa
2. Connect the Y-Cable: Attach the Y-cable (O) to both the backrest connection cable and the power supply (M).
3. Plug in the Power Supply: Insert the power supply (M) into the cable (N), then plug the cable into a wall outlet.

TIP: Ensure all connections are firmly secured to prevent any power interruptions.

Step 7

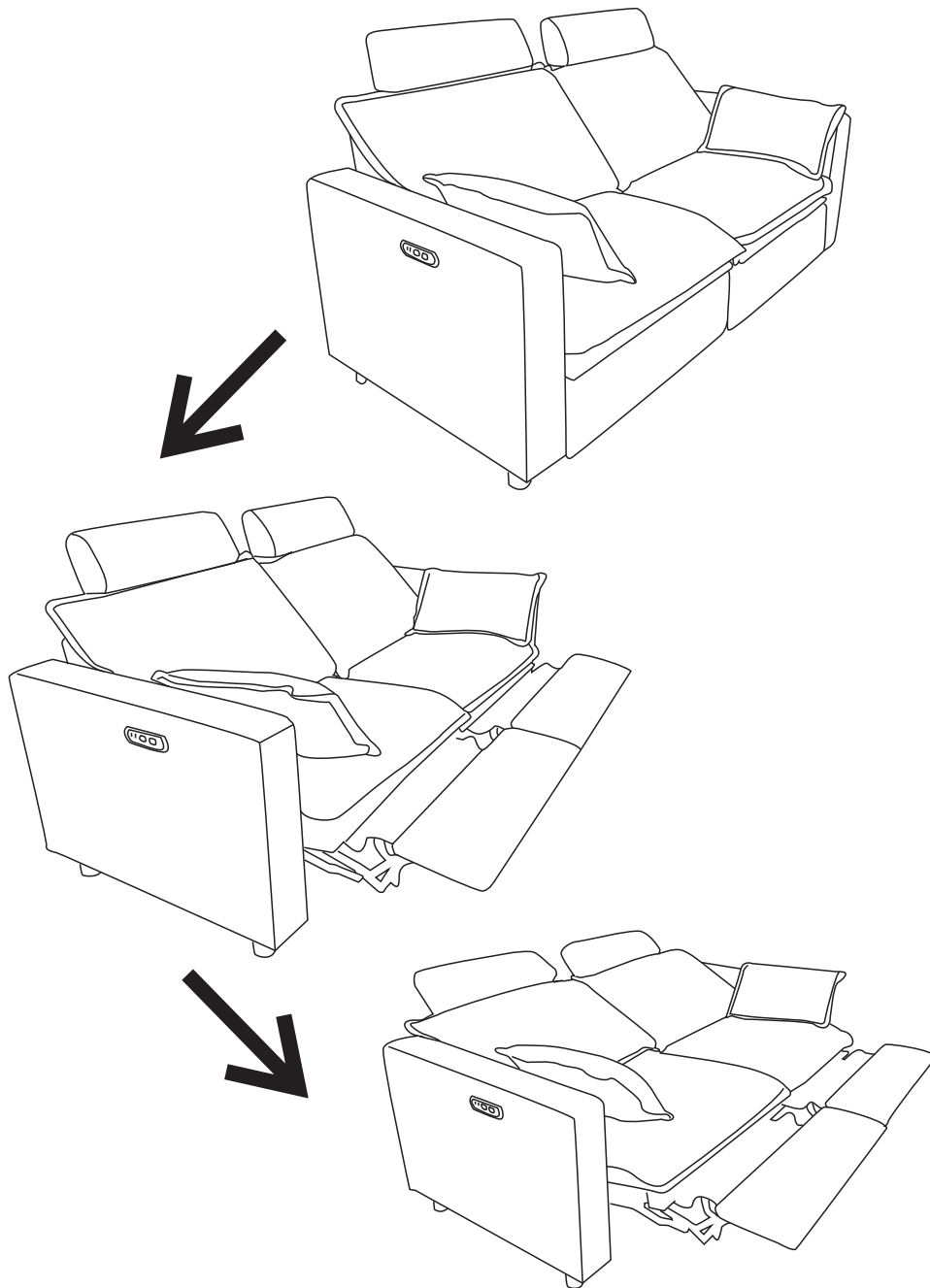

Congratulations on completing your couch installation! Now it's time to enjoy your new piece of furniture.





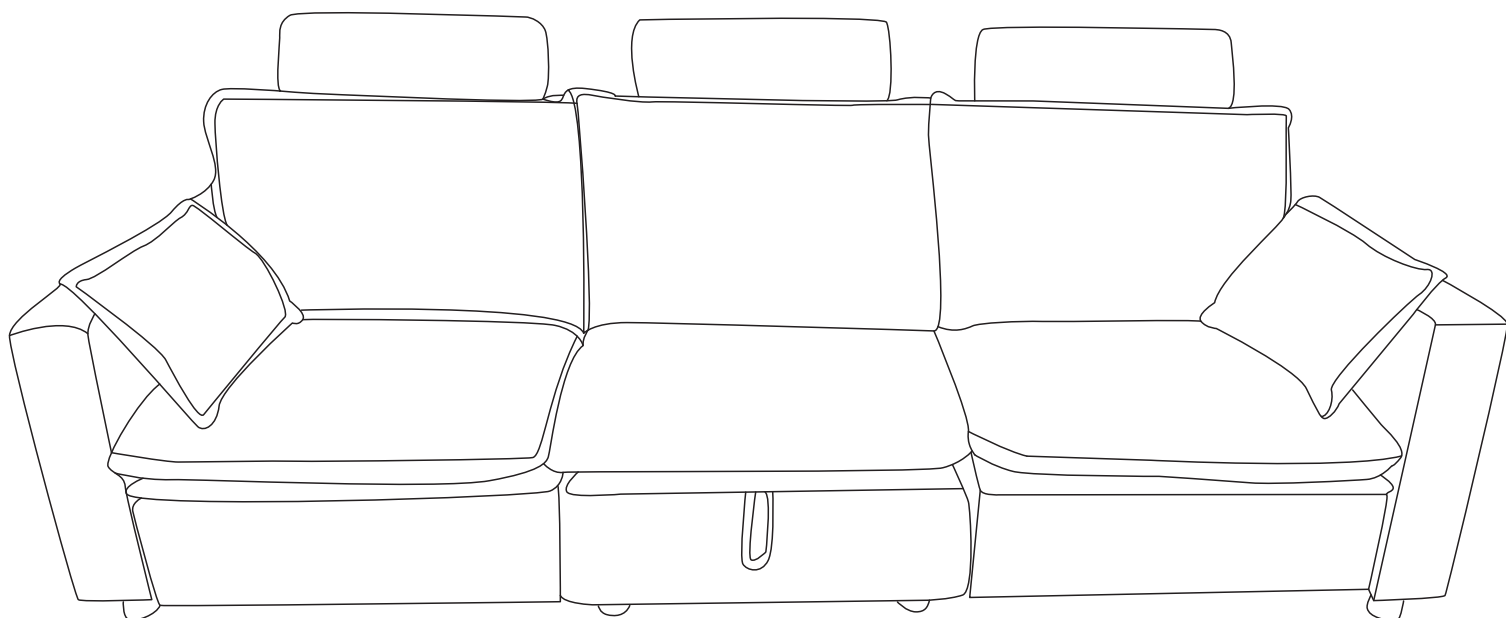

Feel free to adjust the angle to find your perfect level of comfort.

Electric 3-Seater Sofa

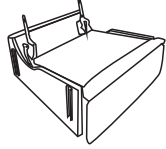

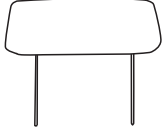

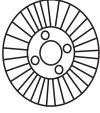

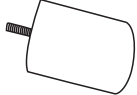

Installation instructions

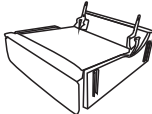

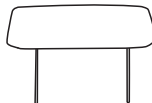

Parts Listing

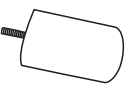
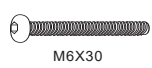
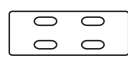
BOX-A			
NO.	DRAWING	QTY	DESCRIPTION
A		1	SEAT
B		1	BACK REST
C		1	BACKREST PADDING
D		1	PILLOW
E		1	PILLOW
F		1	SEAT PADDING
G		6	GASKETS
H		4	LEGS
I		2	LEGS





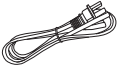

Parts Listing

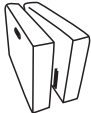
BOX-B			
NO.	DRAWING	QTY	DESCRIPTION
A1		1	SEAT
B		1	BACKREST
C		1	BACKREST PADDING
D		1	PILLOW
E		1	PILLOW
F		1	SEAT PADDING
G		6	GASKETS
H		4	LEGS
I		2	LEGS
J	 M6X30	8	SCREW
K		2	CONNECTOR
L		1	ALLENKEY
M		1	POWER SOURCE

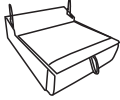
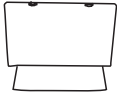
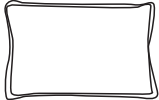
Parts Listing

BOX-B			
NO.	DRAWING	QTY	DESCRIPTION
N		1	CONNECTION WIRE
O		1	Y-CABLE

BOX-C			
NO.	DRAWING	QTY	DESCRIPTION
P		2	ARM

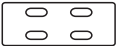
BOX-D			
NO.	DRAWING	QTY	DESCRIPTION
A2		1	SEAT
B		1	BACK REST
C		1	BACKREST PADDING
D		1	PILLOW
F		1	SEAT PADDING
G		4	GASKETS
H		4	LEGS
J	 M6X30	8	SCREW
K		2	CONNECTOR

Step 1

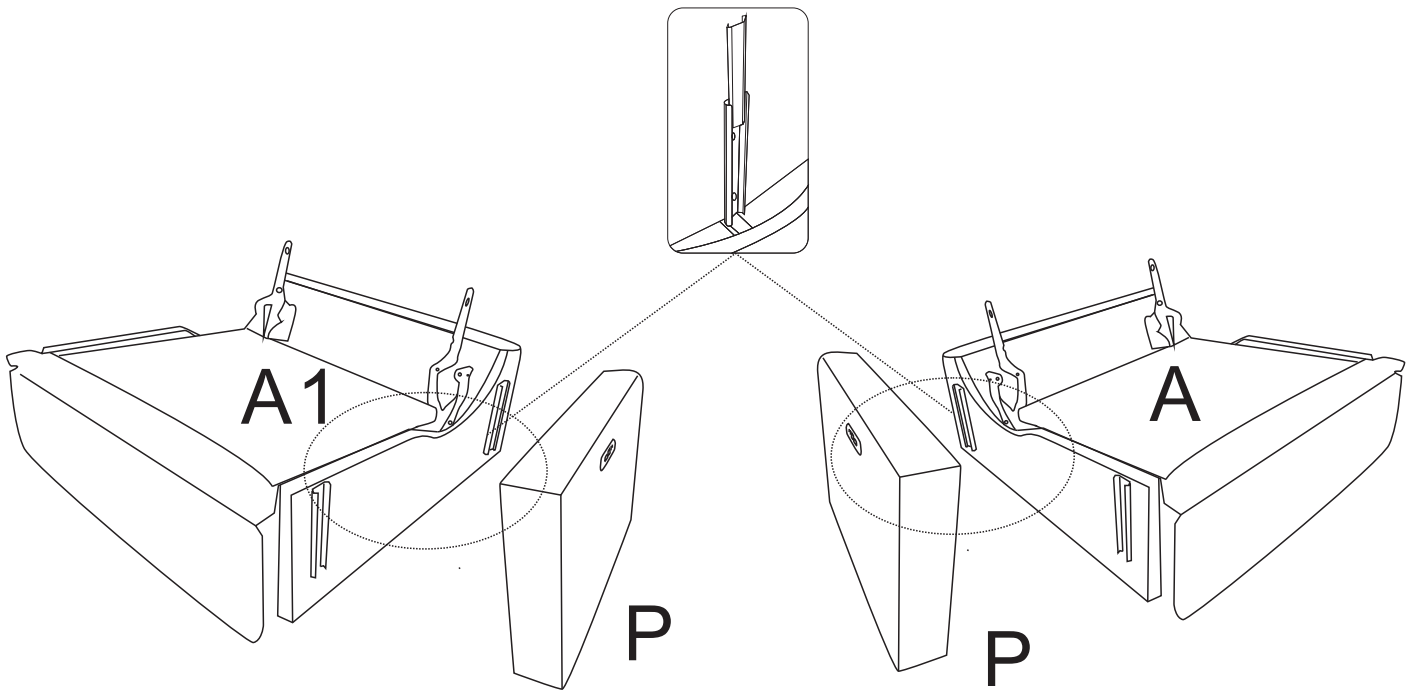

Attaching the Armrests

1. Locate the armrests (P) in BOX C.
2. Align each armrest (P) with the corresponding side of the seat (A/A1).

Step 2

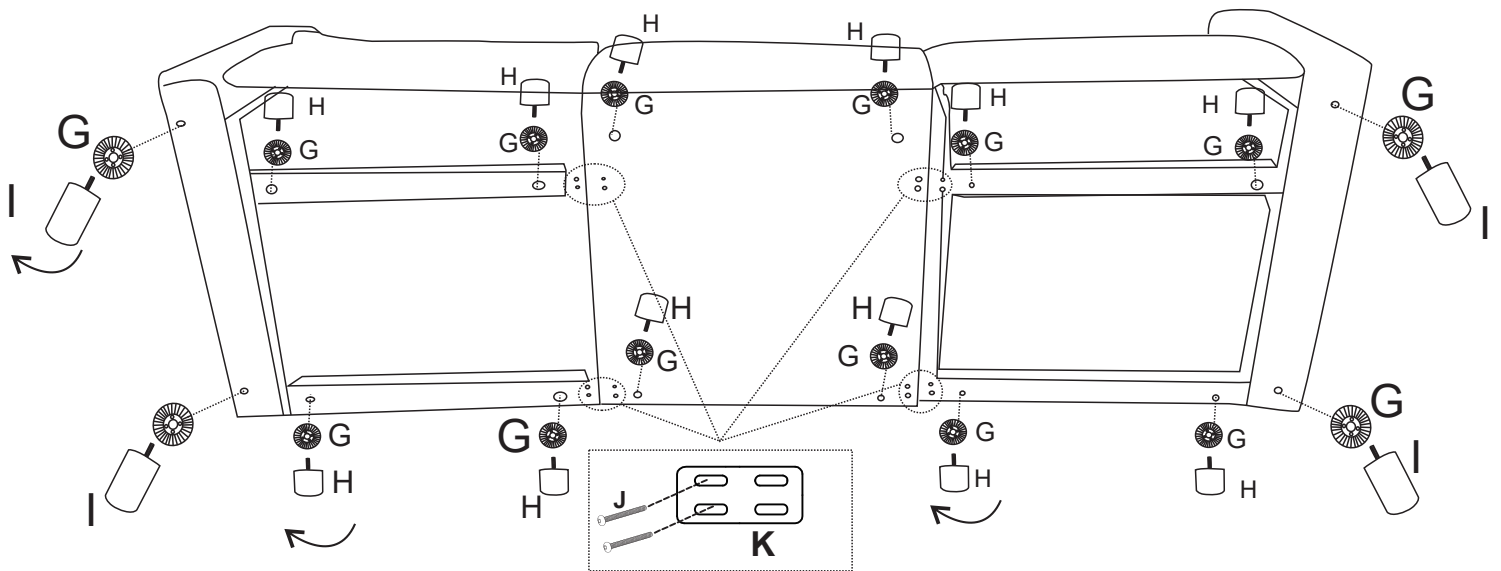

STEP 2: Connecting the Sofa & Installing the Legs

1. Connect the Seats: Use the provided M6X30 screws (J) and connecting plates (K) to join the two seats (A and A1) together. Tighten the screws with the Allen Key (L).

2. Install the Legs:

- Attach the 4 long legs (I) to the bottom of the armrests (P) using the gaskets (G).
- Attach the 12 short legs (H) to the bottom of the seats (A and A1) using the gaskets (G).

Tip: Ensure the legs are properly aligned to avoid any difficulties during installation.

Step 3

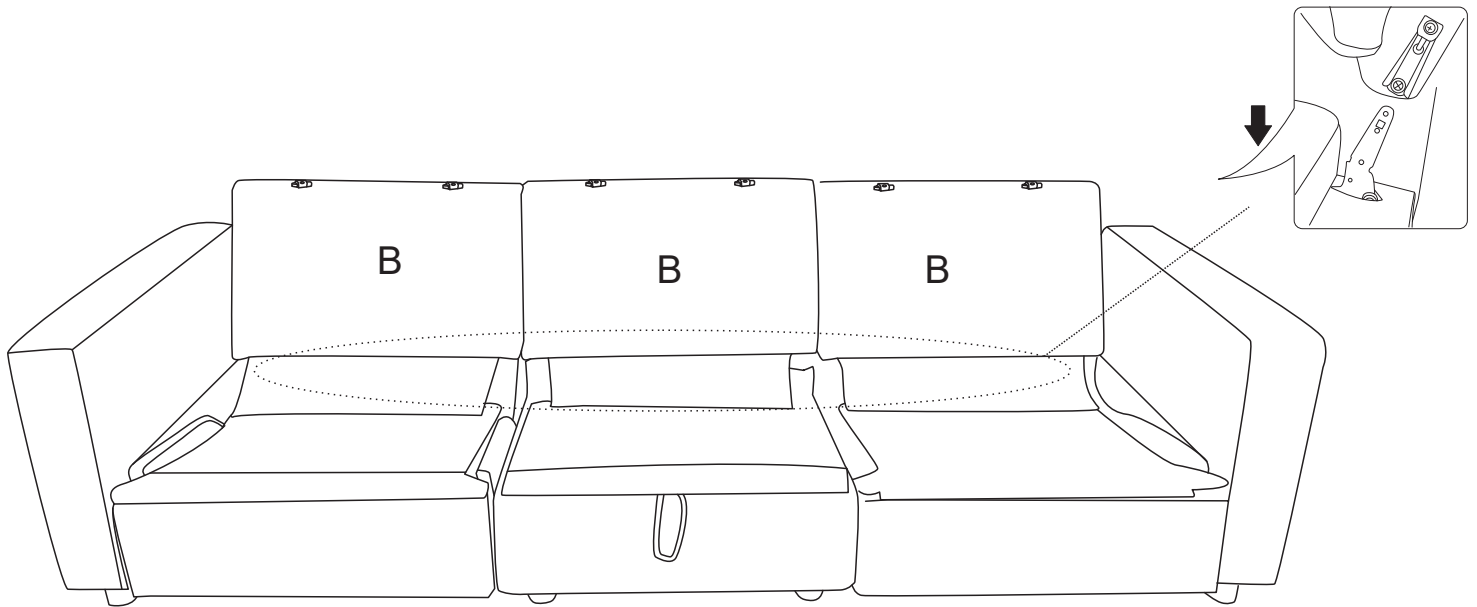

Connecting the Backrest

Attach the Backrest (B) to the Seat (A/A1/A2) by aligning the connectors.

Slide the backrest downwards until you hear a click, indicating it's securely attached.

Tip: Ensure that the backrest is properly aligned with the seat before sliding it into place.

Step 4

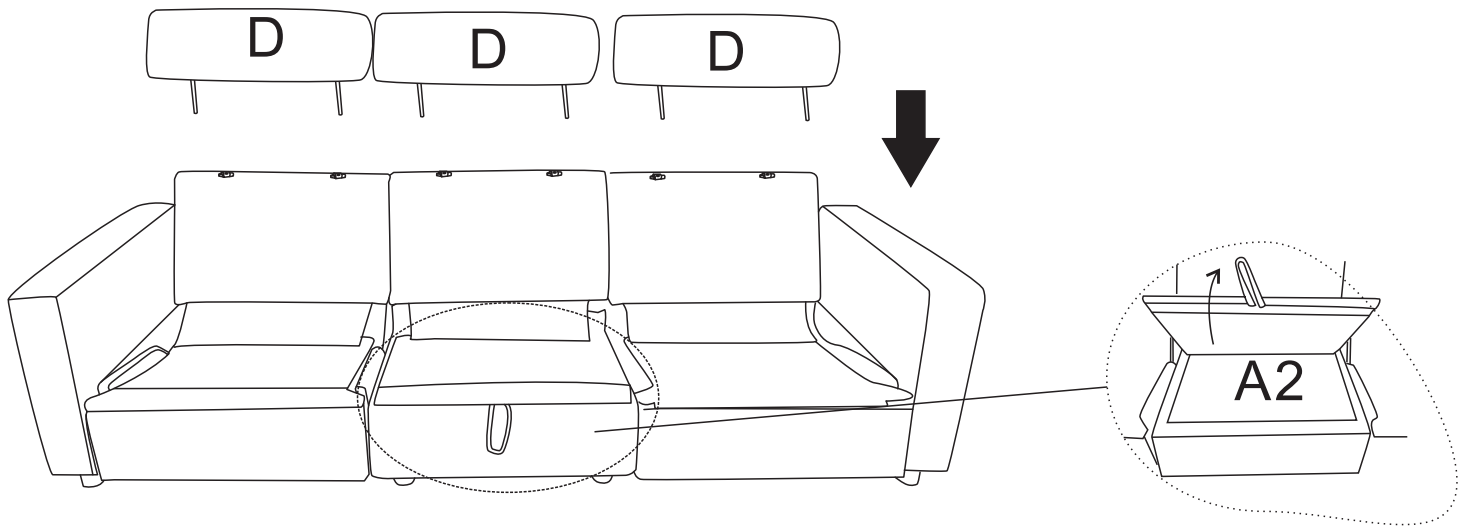

Installing the Headrest

Align the holes on the headrest (D) with the corresponding slots on the backrest (B). Once aligned, securely attach the headrest to the backrest by gently pressing it down until it clicks into place. Make sure the headrest is firmly installed before proceeding to the next step.

Note: The center seat, labeled A2, features a built-in storage box.

Step 5

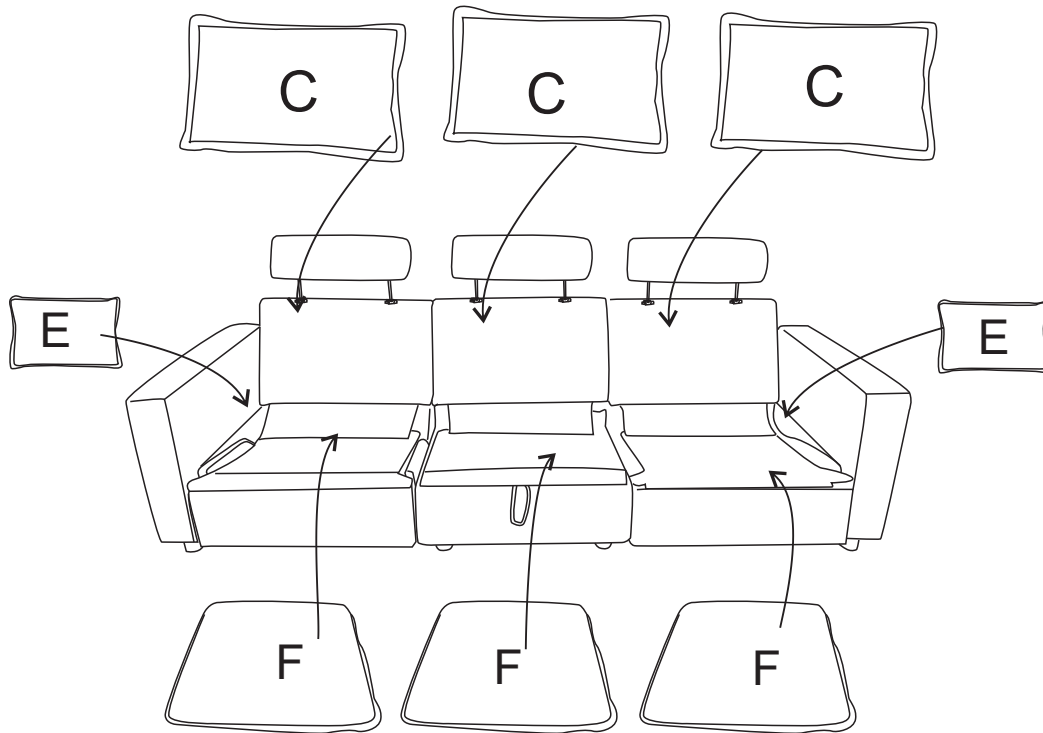

Arrange the Backrest, Cushion, and Pillows

1. Place the backrest (C) to the back of the chair as illustrated in the diagram.
2. Position the cushion (F) evenly on the seat.
3. Arrange the small pillows (E) to your liking.

Pro Tip: For a neat and polished appearance, smooth out any wrinkles in the fabric.

Step 6

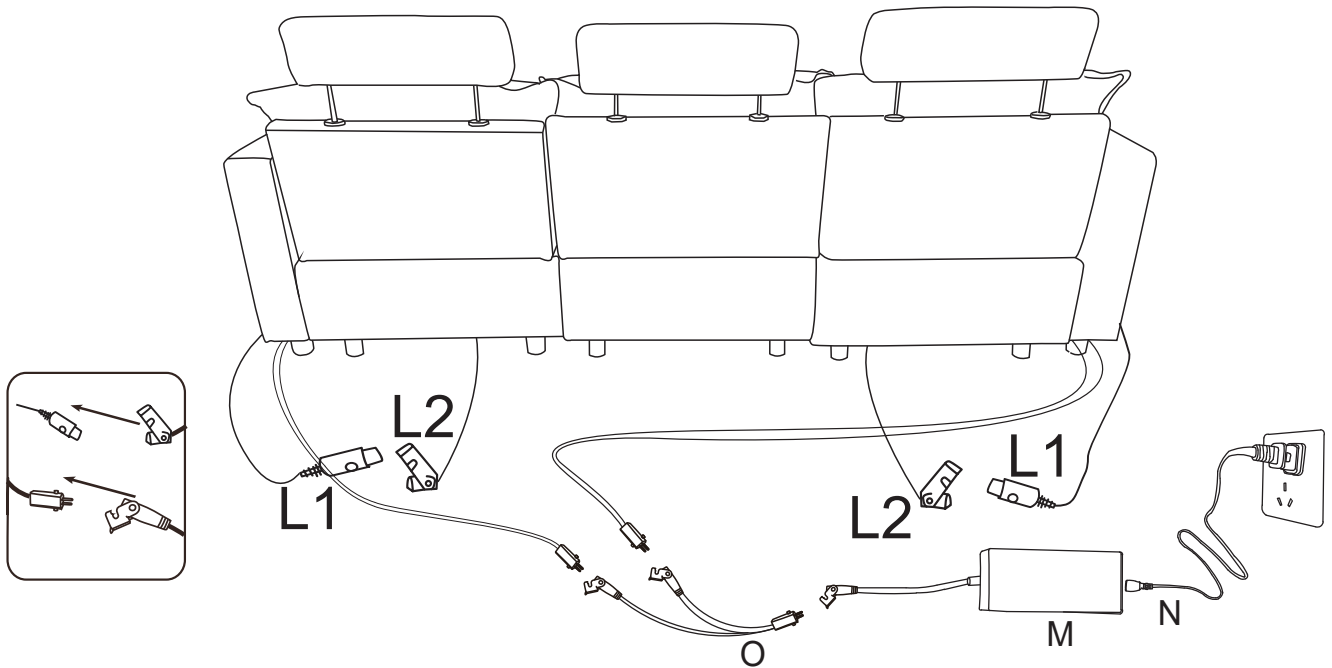

Connecting Power

1. Connecting the L1 and L2 lines behind the sofa
2. Connect the Y-Cable: Attach the Y-cable (O) to both the backrest connection cable and the power supply (M).
3. Plug in the Power Supply: Insert the power supply (M) into the cable (N), then plug the cable into a wall outlet.

TIP: Ensure all connections are firmly secured to prevent any power interruptions.

Step 7

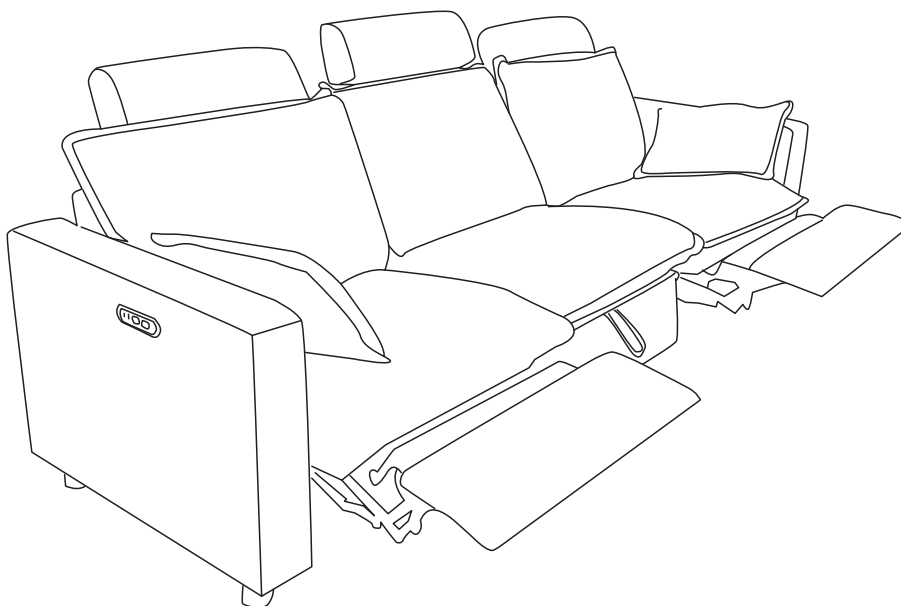
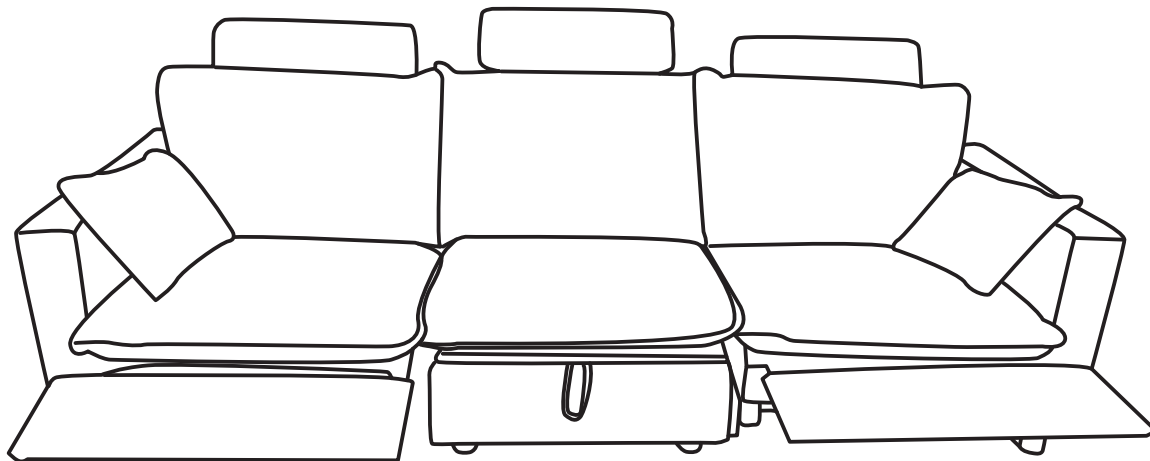

Congratulations on completing your couch installation! Now it's time to enjoy your new piece of furniture. Feel free to adjust the angle to find your perfect level of comfort.