

# ASSEMBLY INSTRUCTION

(1) x 1

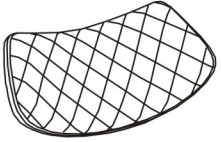

(6) x 1

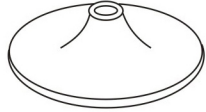

(2) x 1

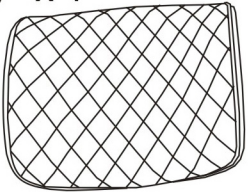

(7) x 7+1EXTRA

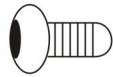

6x20MM

(3) x 1



(8) x 4+1EXTRA

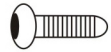

6x16MM

(4) x 1

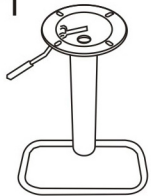

(9) x 1

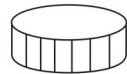

(5) x 1



(10) x 1



1

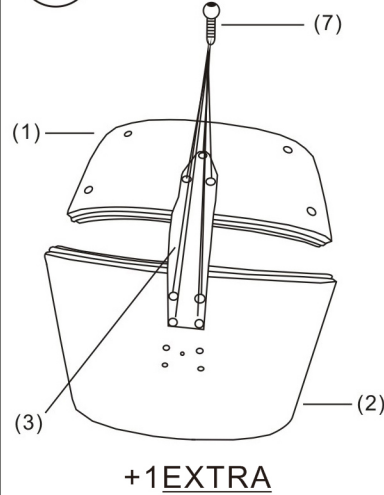

2

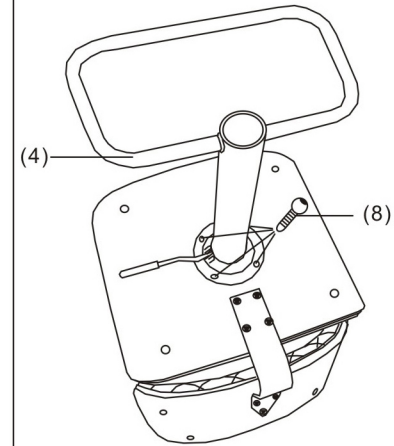

3

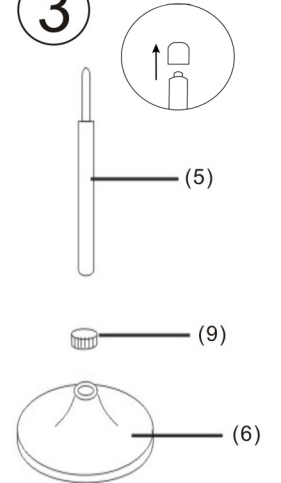

4

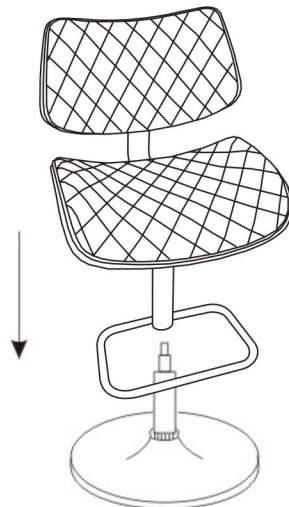

5

