

5-6/8

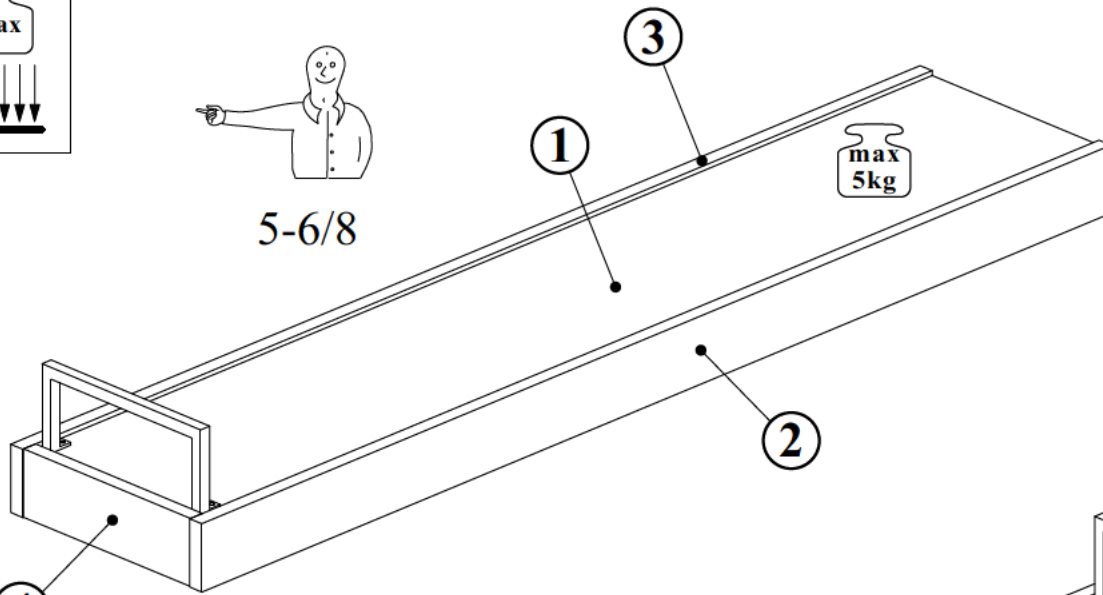

7-8/8

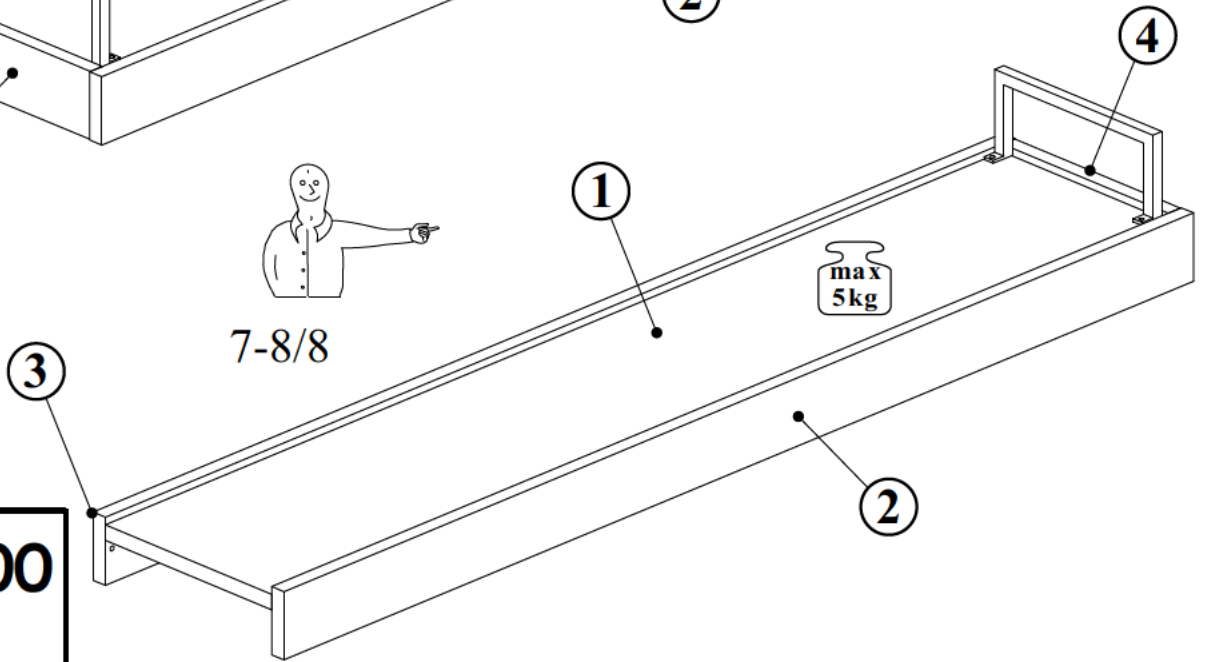

→ 1200
 ↑ 70
 ↗ 252

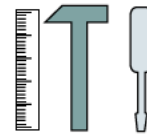

NO	Dim.		Col.-No	Qty	
1	1183	220	16	1/3	1
2	1200	70	16	1/3	1
3	1200	70	16	1/3	1
4	220	70	16	1/3	1

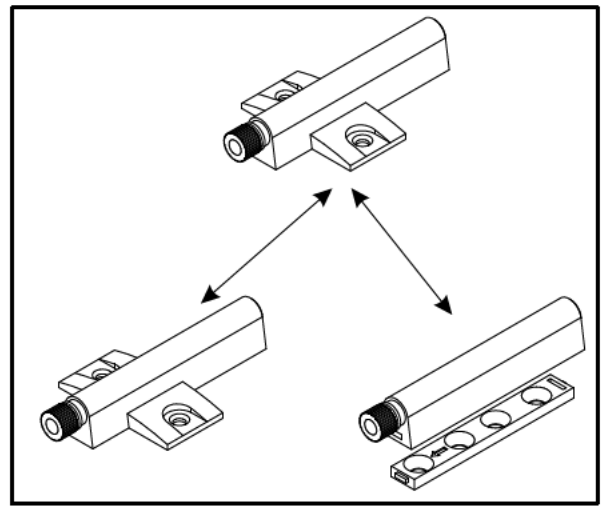
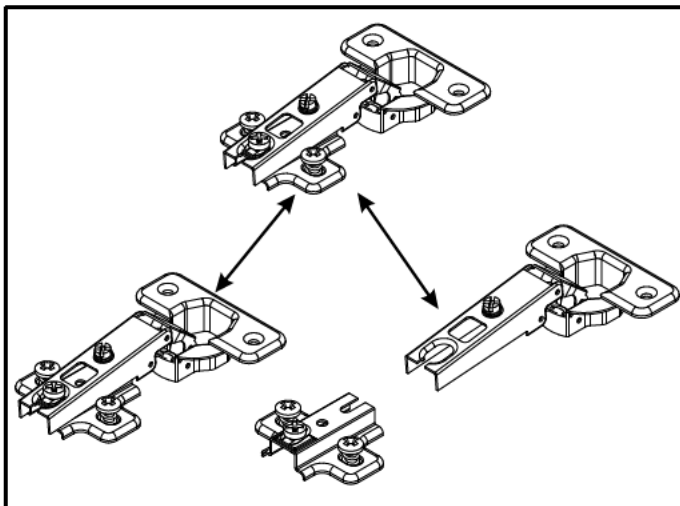
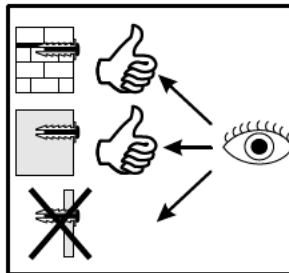
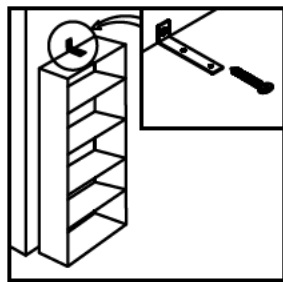
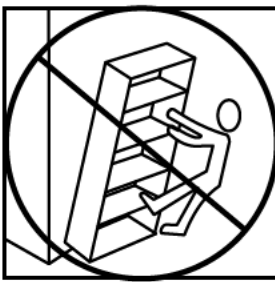
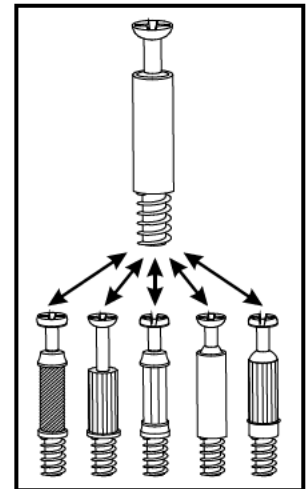
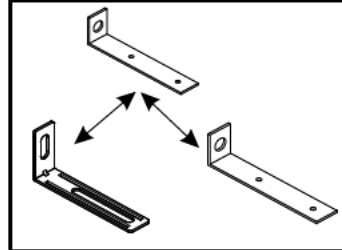
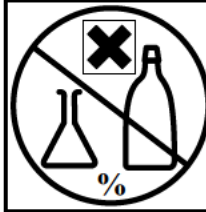
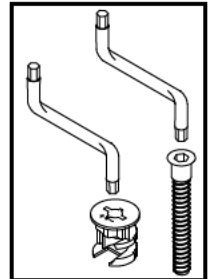
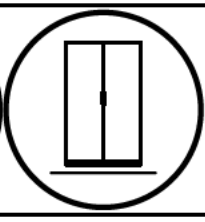
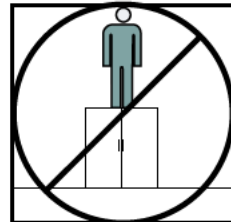
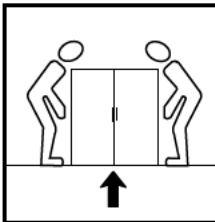
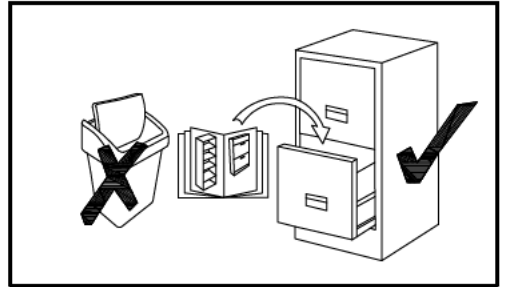
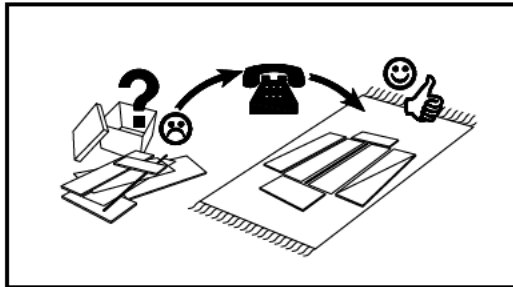
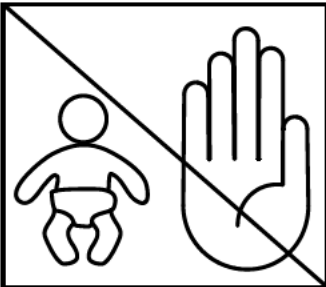
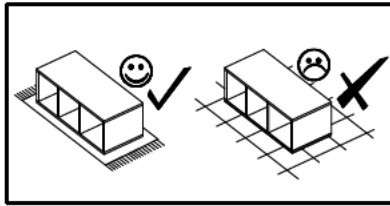
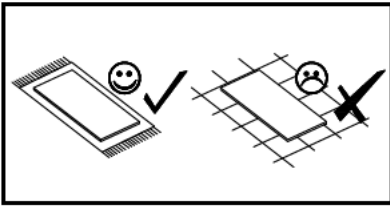

45 min

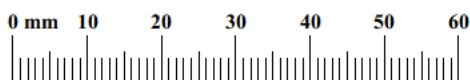
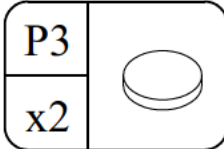
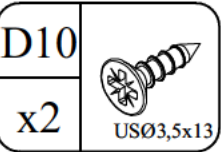
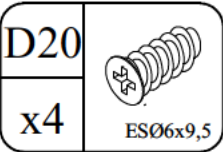
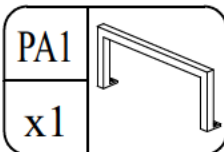
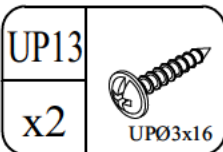
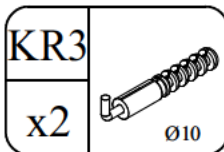
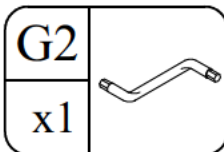
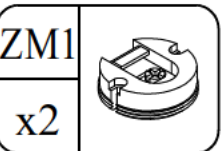
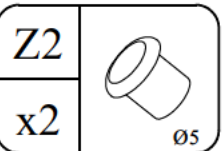
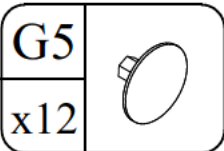
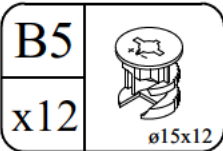
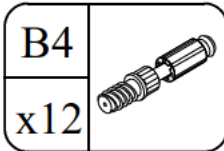
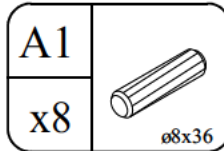

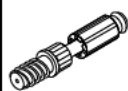

B4		B5		A1	
x2		x12	ø15x12	x8	ø8x36

1

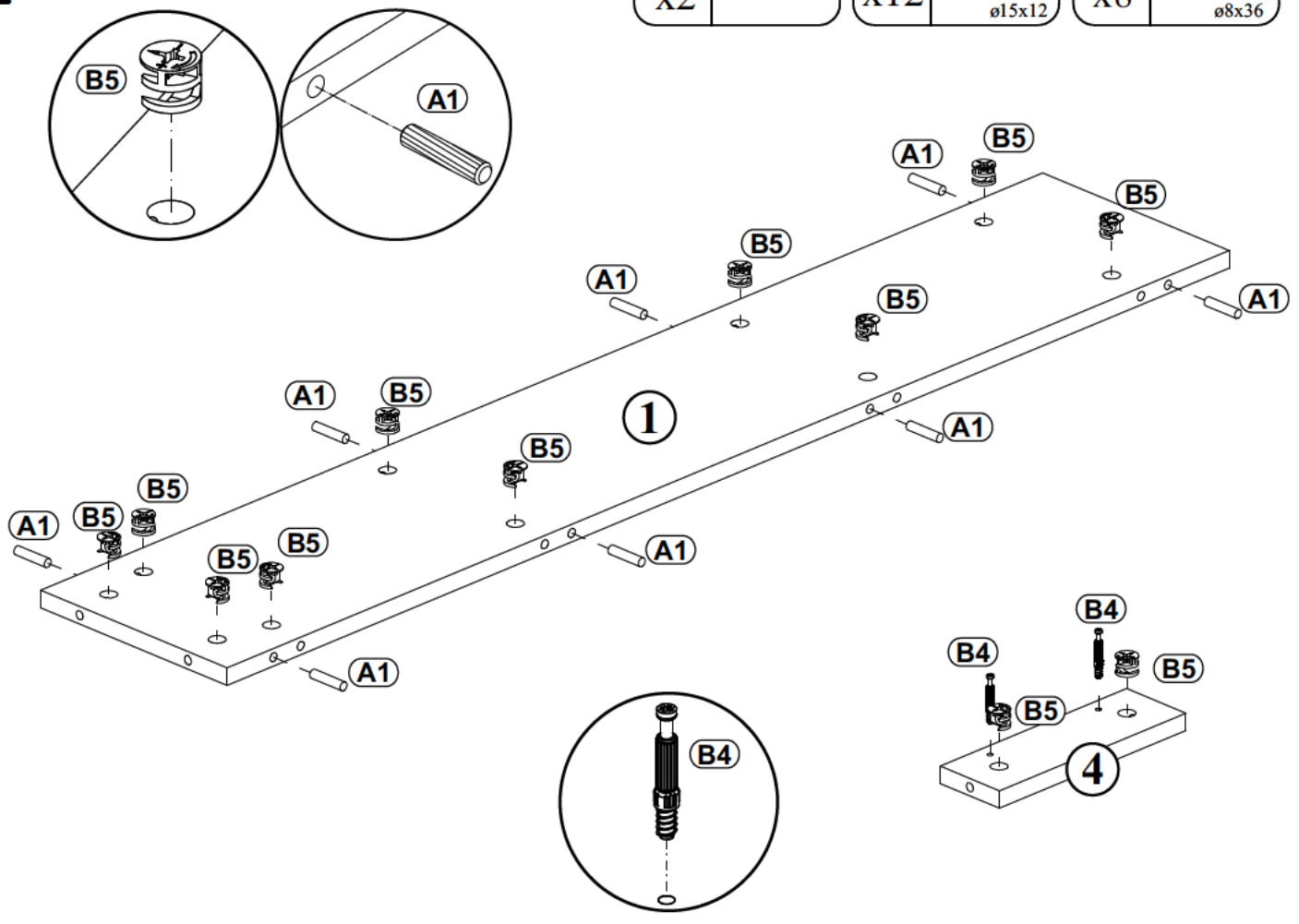

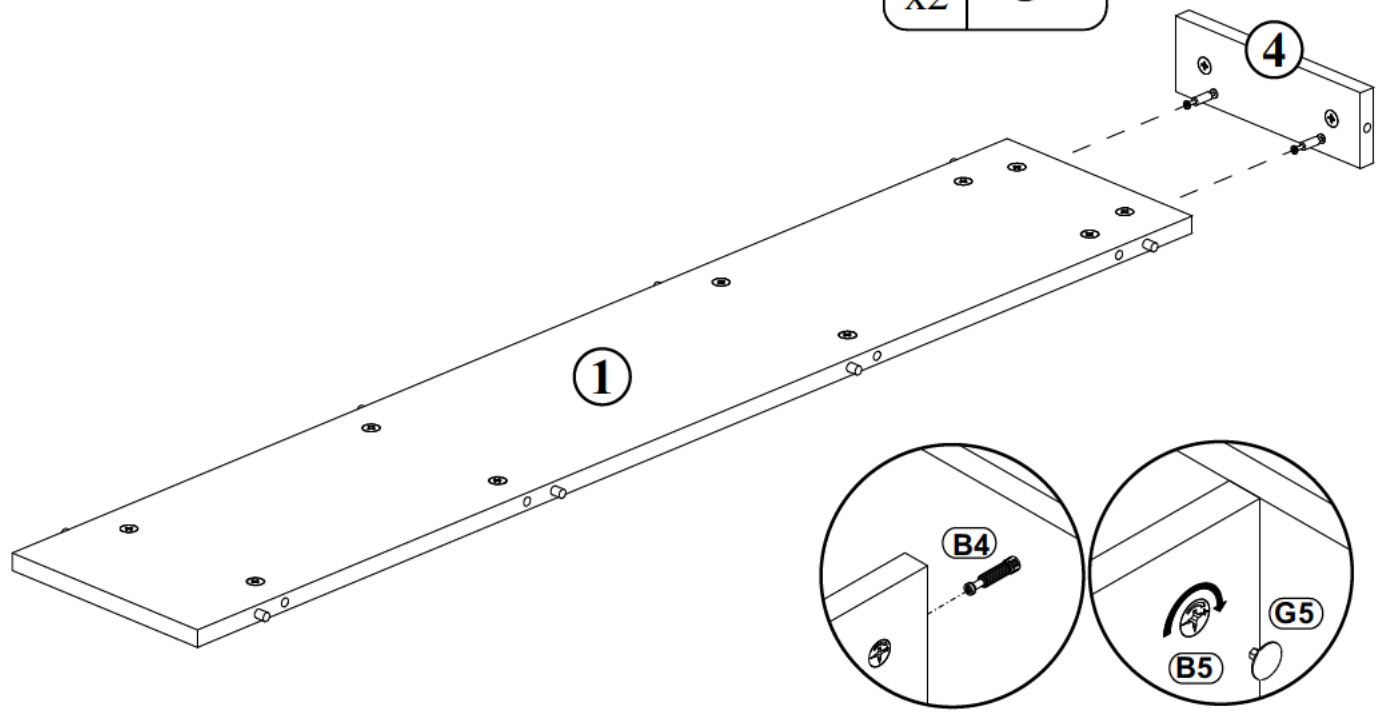

2

G5	
x2	





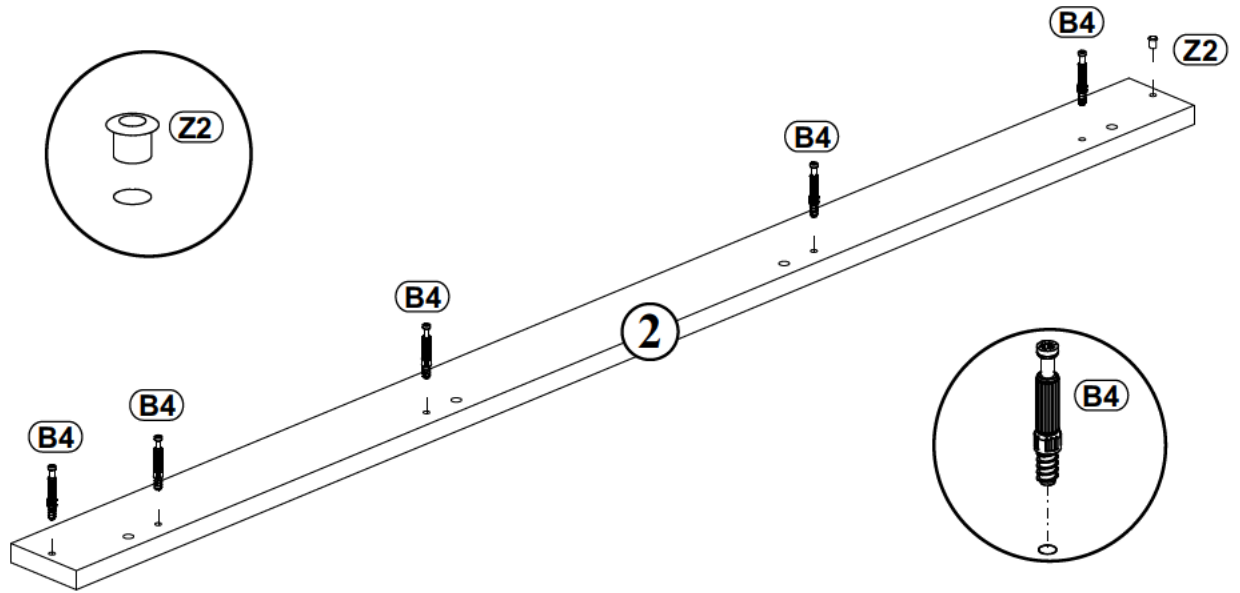

3

Z2		B4	
x1	ø5	x5	

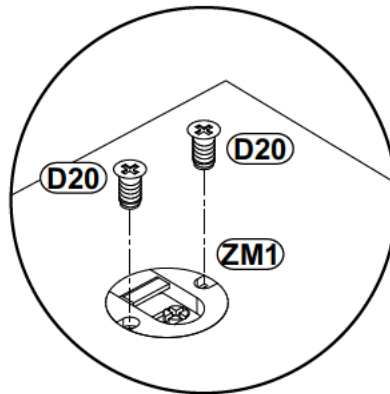
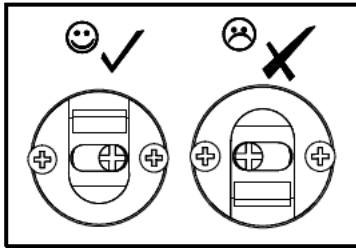

4



ZM1		D20	
x2		x4	ESØ6x9,5
D10		P3	
x2	USØ3,5x13	x2	

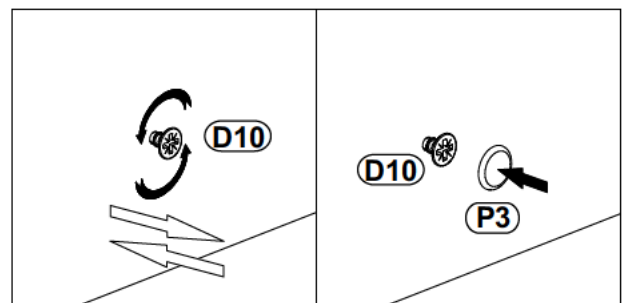
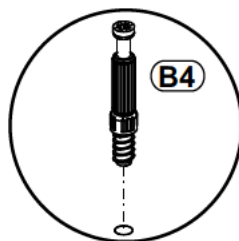
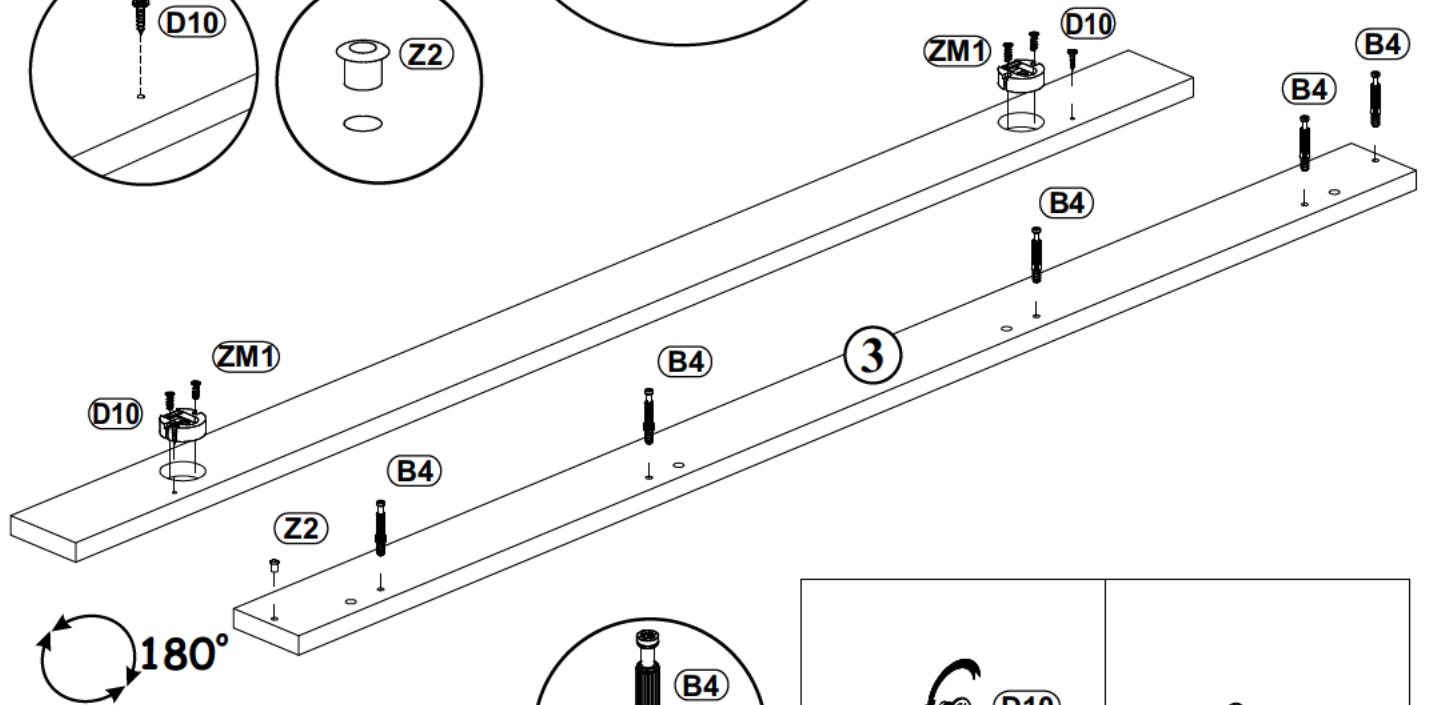
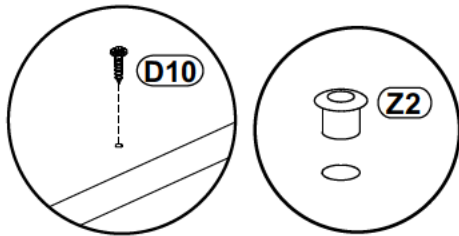

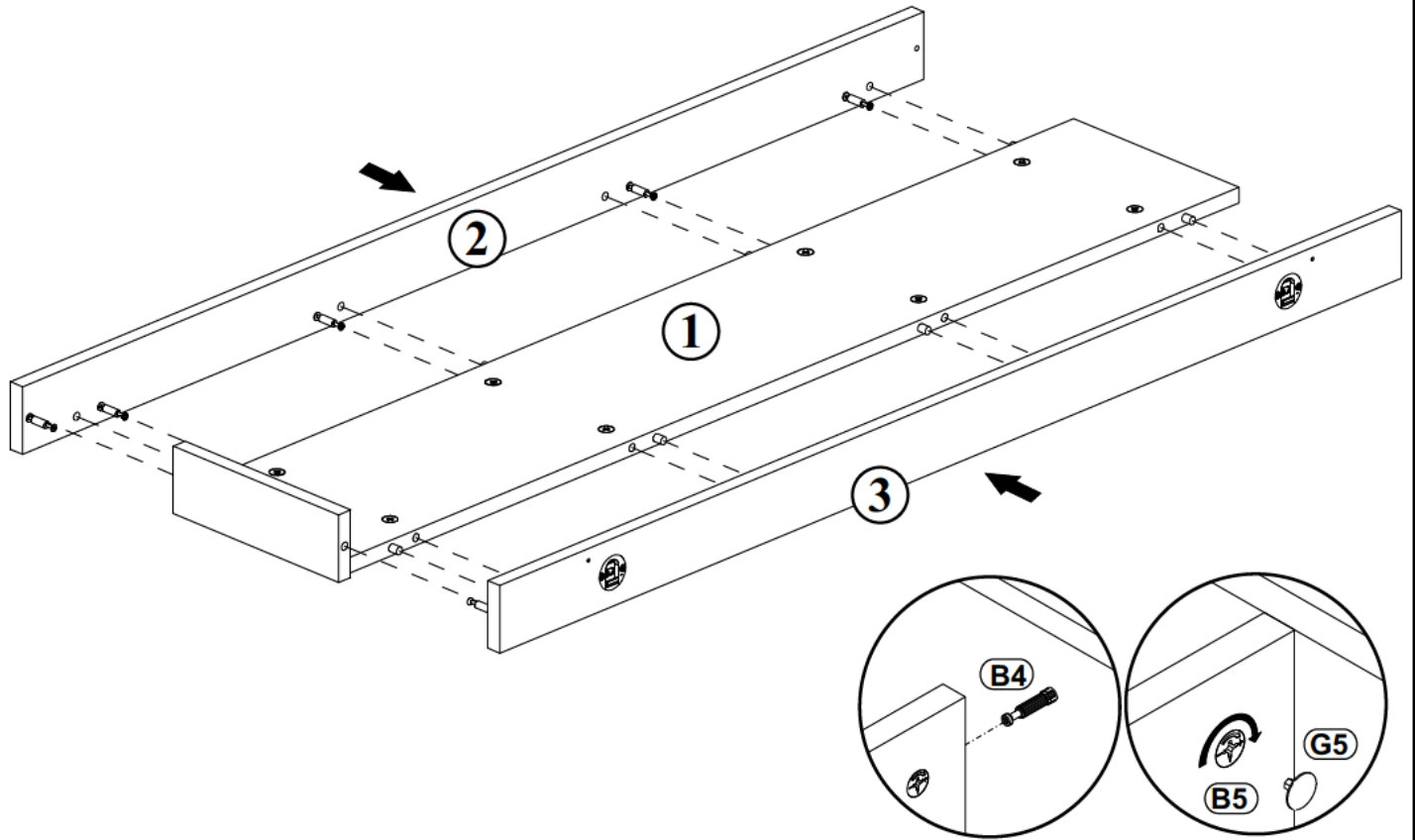

5

G5	
x10	



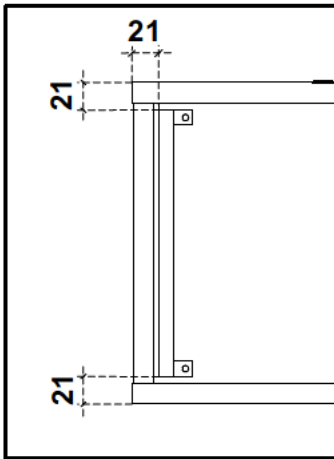

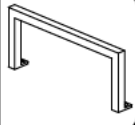
6

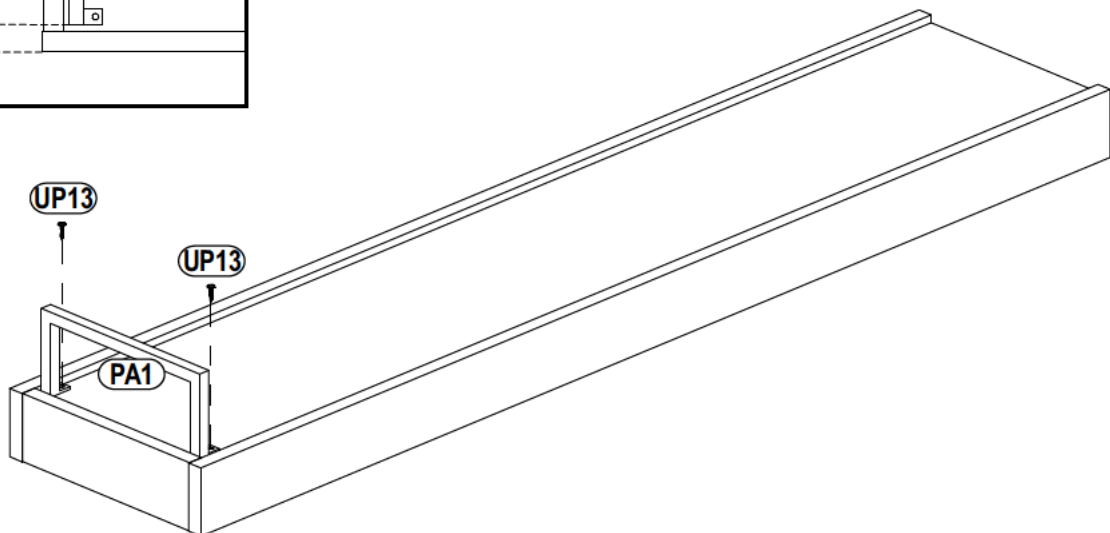

PA1		UP13	
x1		x2	





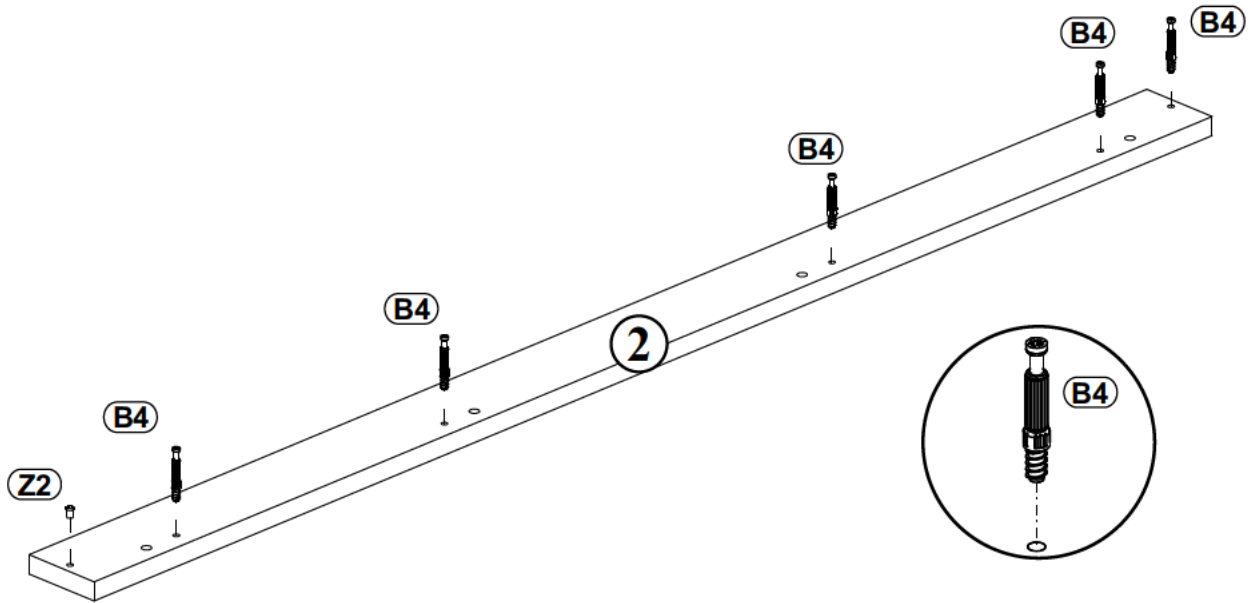

7

Z2		B4	
x1	ø5	x5	

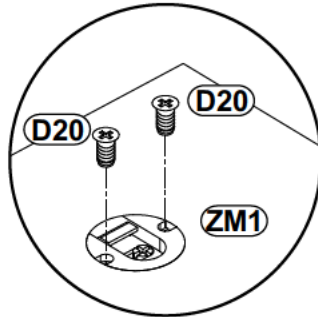
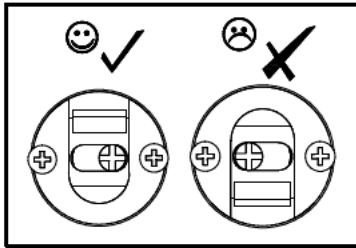

8



ZM1		D20	
x2		x4	ESØ6x9,5
D10		P3	
x2	USØ3,5x13	x2	

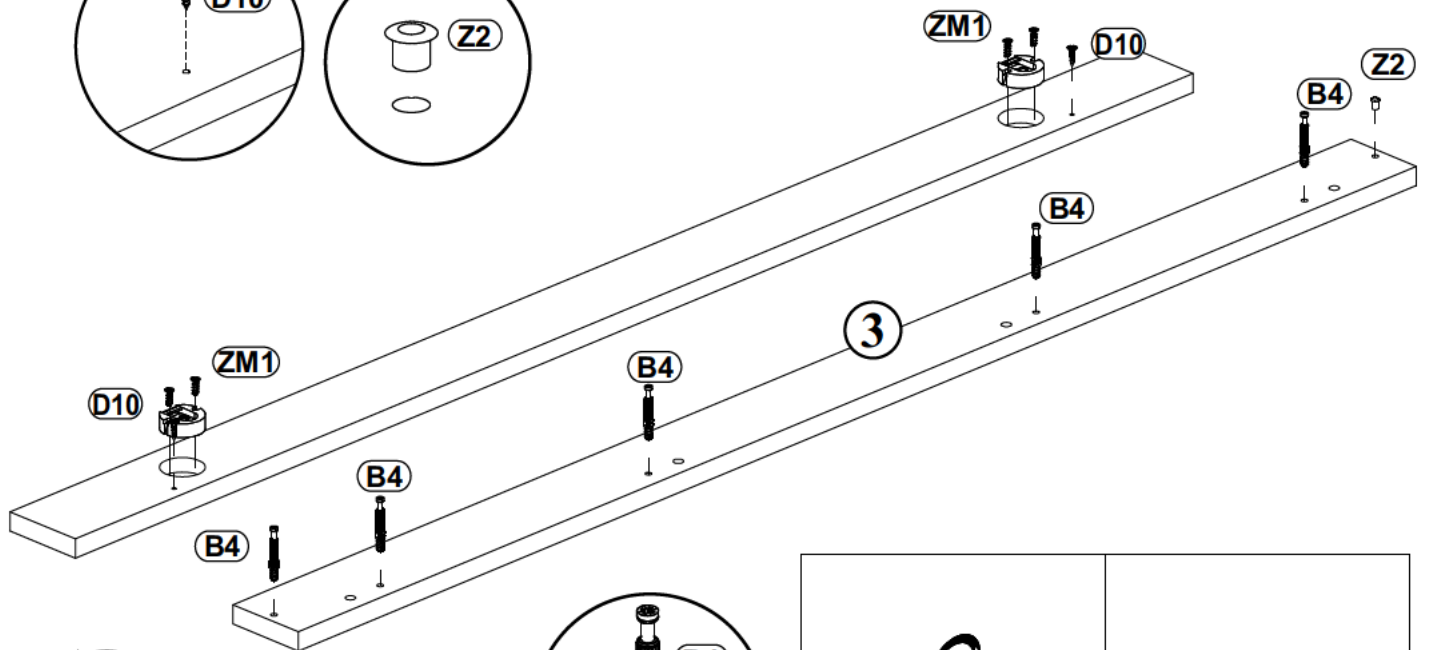
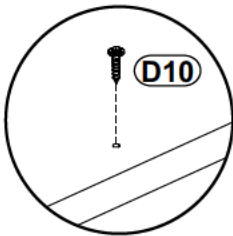

180°

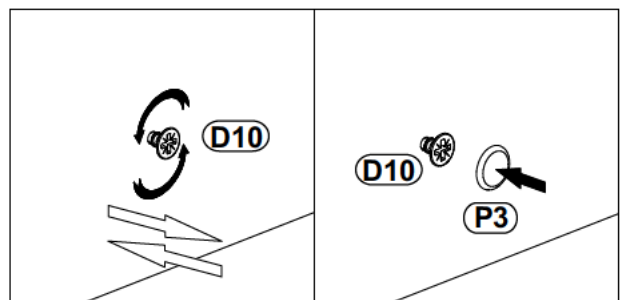
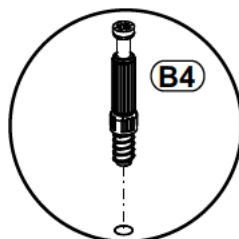

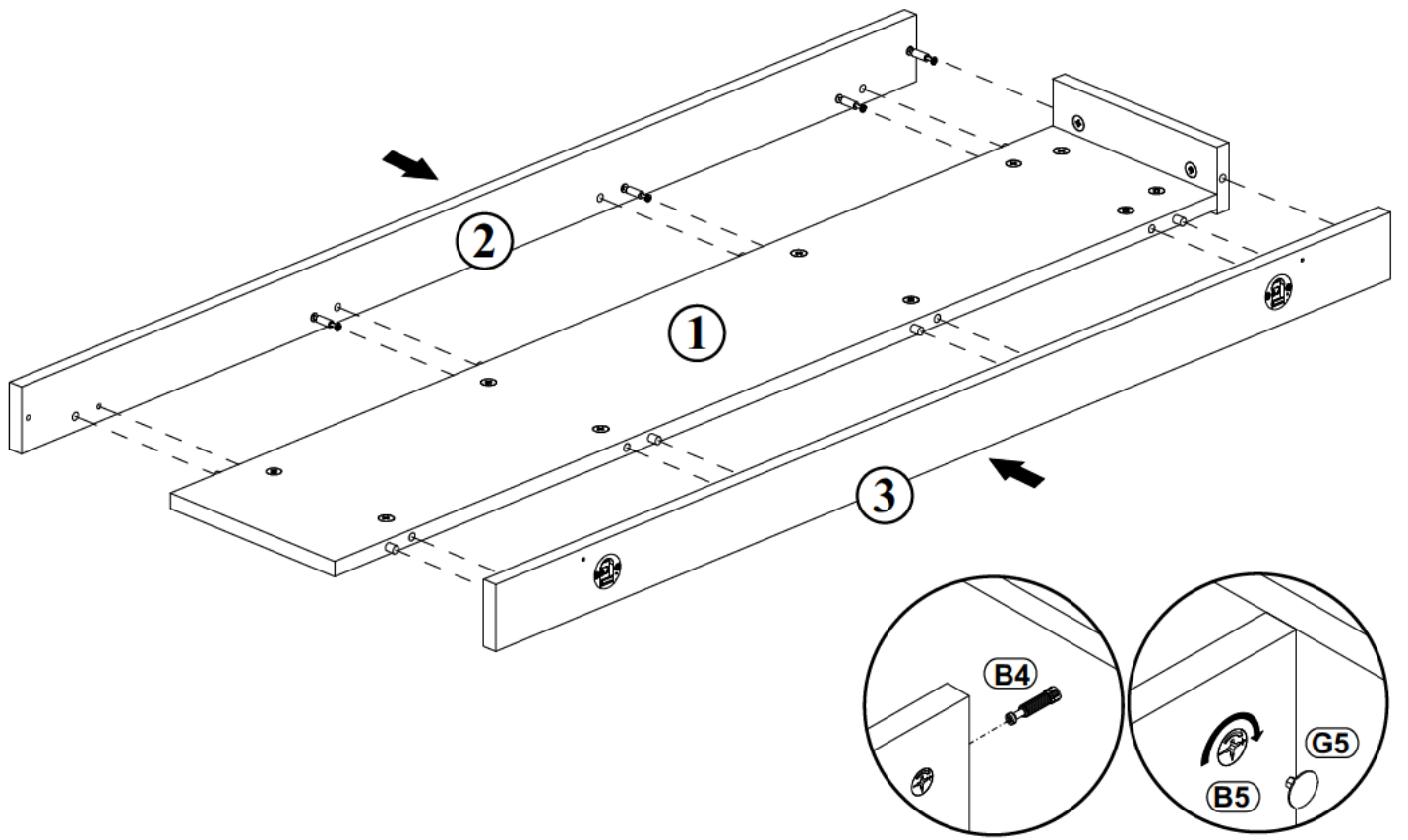

9

G5	
x10	

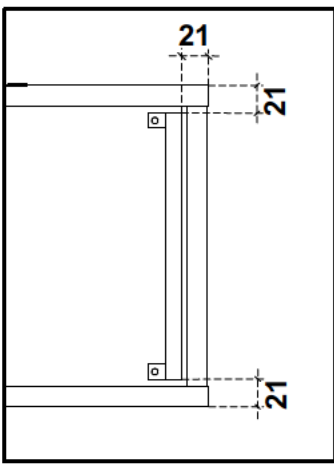

10

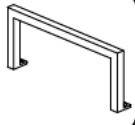

PA1		UP13	
x1		x2	UPØ3x16

