

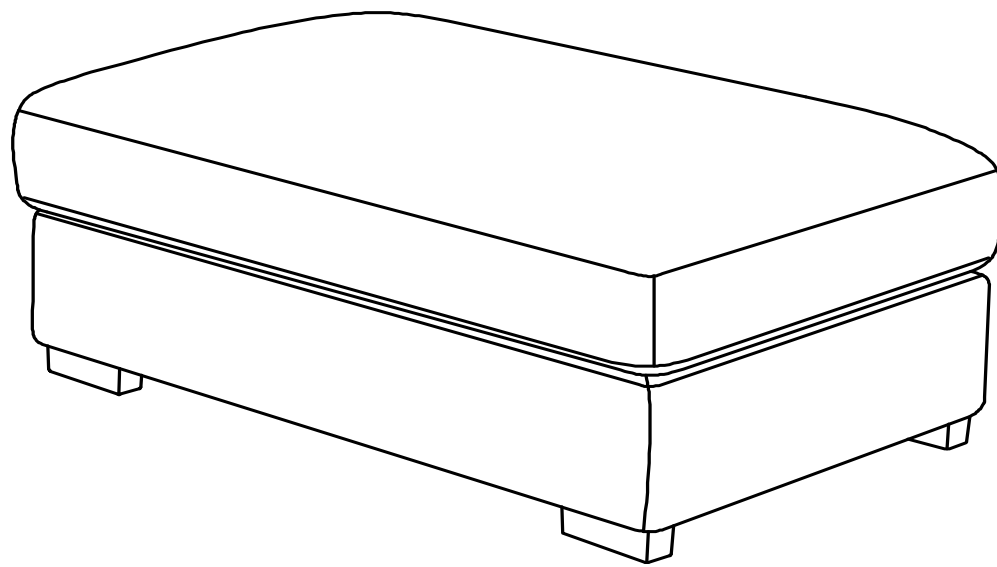

ASSEMBLY INSTRUCTION

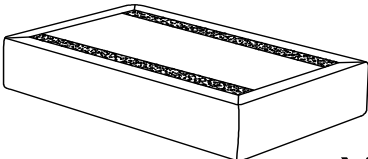
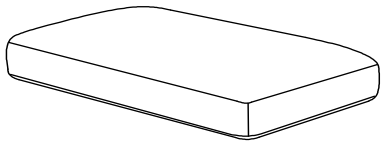
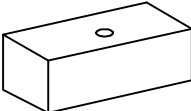
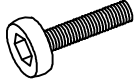

PARTS LIST

A  X1	B  X1	C  X4	D  X4	E  X4
F  X1				

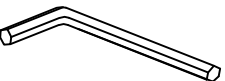
Packing list:

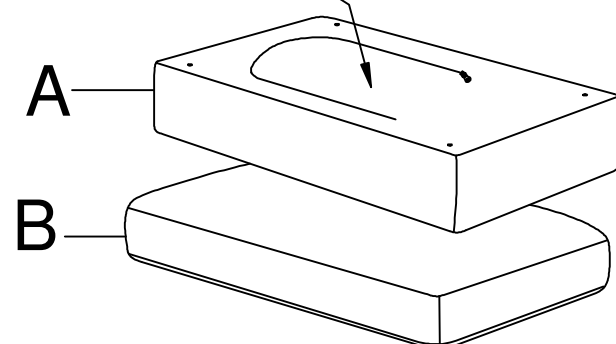
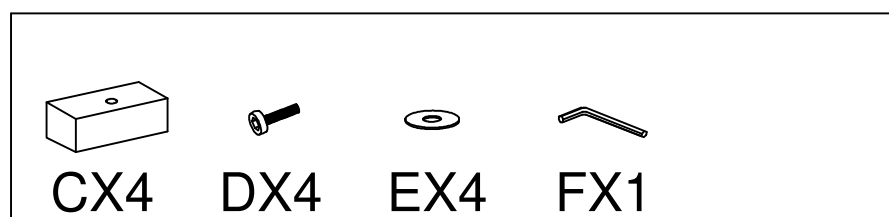

Carton 8/8

STEP 1:

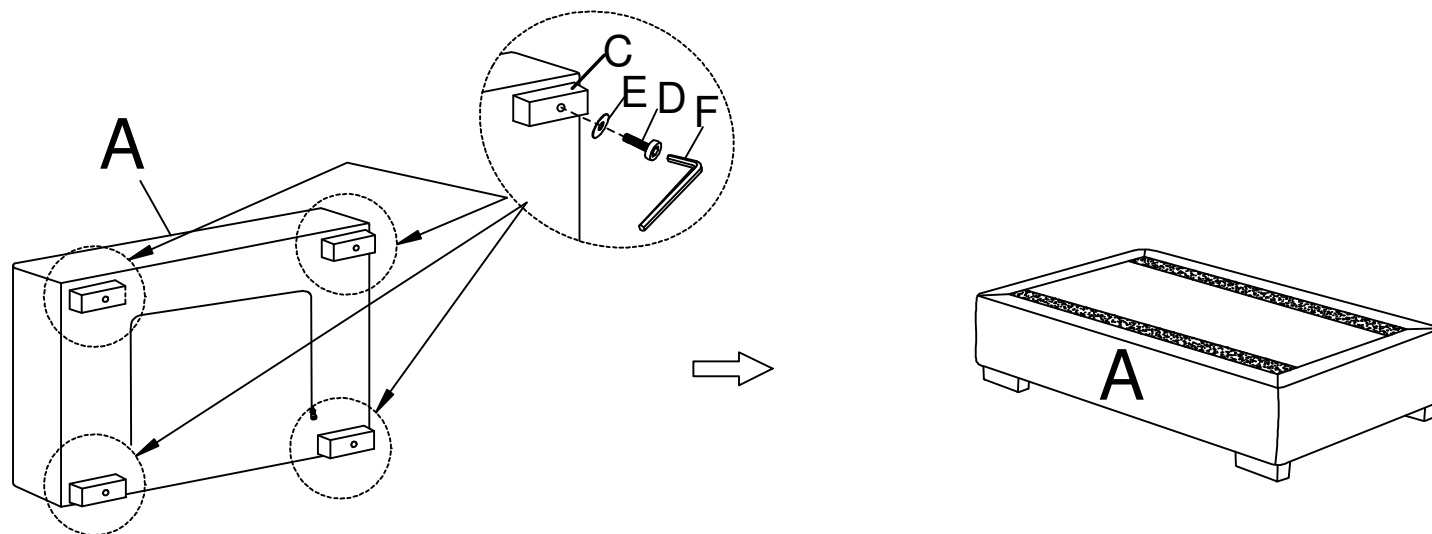

STEP 2:

