

MAINTENANCE

WARNING! Risk of electric shock! DO NOT OPEN! No user-serviceable parts inside!

Electrical and Moving Parts:

- The fan motors are lubricated at the factory and will not require lubrication.
- Electrical components are integrated in the fireplace and are not serviceable by the consumer.

LIMITED WARRANTY

This warrants to the original purchaser that this product is free from defects in material and workmanship as of the date of purchase and that it will, under normal use and proper care, remain so for one year from the date of purchase. Missing or initially defective parts will be replaced free of charge during the period of this limited warranty. If parts are unavailable, comparable replacement or refund will be given. **The original dated sales receipt is required for all warranty claims.** This warranty does not cover damage which has occurred during transport from the point of purchase to the consumer's home. This warranty does not cover glass, light bulbs, batteries, transportation, labor, or other issues not associated with the manufacture of the product.

This product is for residential use only. Any and all commercial use of this product voids all warranties, and frees the manufacturer from all liability.

AK0001/AK0002 INSTRUCTION MANUAL

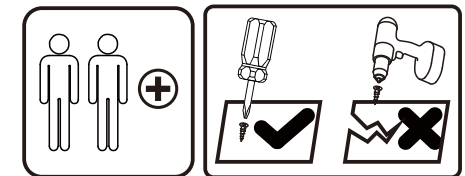
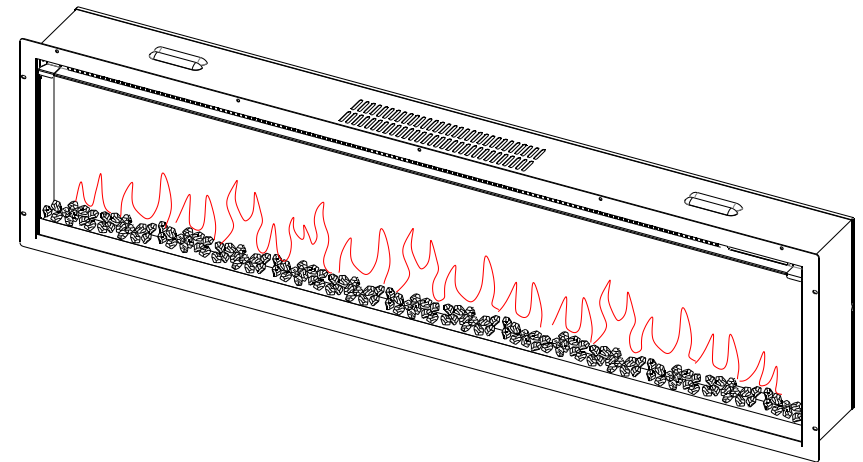

Tools Recommended

This Instructions Contains Important Safety Information. Please Read Before Assembly And Keep For Future Reference.
Need Parts Or Assistance? Email Us At Riching@nbrehome.com

IMPORTANT SAFETY INFORMATION

- Read all of the instructions before using this appliance.
- This heater is hot when in use. To avoid burns, do not let bare skin touch hot surfaces. If provided, use handles when moving this heater. Keep combustible materials, such as furniture, pillows, bedding, papers, clothes, and curtains at least a 3 feet (a 0.9m) from the front of the heater and keep them away from the sides and rear.
- Extreme caution is necessary when any heater is used by or near children or invalids and whenever the heater is left operating and unattended.
- Always unplug heater when not in use.
- Do not operate any heater with a damaged cord or plug or after the heater malfunctions, has been dropped or damaged in any manner. Discard heater, or return to authorized service facility for examination and/or repair.
- Do not use outdoors
- This heater is not intended for use in bathrooms, laundry areas and similar indoor locations. Never locate heater where it may fall into a bathtub or other water container.
- Do not run cord under carpeting. Do not cover cord with throw rugs, runners, or similar coverings. Do not route cord under furniture or appliances. Arrange cord away from traffic area and where it will not be tripped over.
- To disconnect heater, turn controls to off, then remove plug from outlet.
- Connect to properly grounded outlets only.
- Do not insert or allow foreign objects to enter any ventilation or exhaust opening as this may cause an electric shock or fire, or damage the heater.
- To prevent a possible fire, do not block air intakes or exhaust in any manner. Do not use on soft surfaces, like a bed, where openings may become blocked.

CLEANING

WARNING! ALWAYS turn the heater OFF and unplug the power cord from the outlet before cleaning, performing maintenance, or moving this fireplace. Fail to do so could result in electric shock, fire, or personal injury.

WARNING! NEVER immerse in water or spray with water. Doing so could result in electric shock, fire, or personal injury.

METAL:

- Buff using a soft cloth, slightly dampened with a citrus oil-based product.
- DO NOT use brass polish or household cleaners as these products will damage the metal trim.

GLASS:

- Use a good quality glass cleaner and dry thoroughly with a paper towel or lint-free cloth.
- NEVER use abrasive cleansers, liquid sprays, or any cleaner that could scratch the surface.

PLASTIC:

- Wipe gently with a slightly damp cloth and a mild solution of dish soap and warm water.
- NEVER use abrasive cleansers, liquid sprays, or any cleaner that could scratch the surface.

Vents:

- Use a vacuum or duster to remove dust and dirt from the heater and vent areas.
- Clean the exterior of the fireplace with a slightly damp cloth or duster.

OPEN WINDOW DETECTION

Open Window Detection is an innovative eco feature that detects a rapid drop in room temperature caused by an open window. The warning word "oP" will be displayed on the appliance and the heater will be turned off. If the room temperature rises or the remote control is operated manually, the heater will return to its normal working state.

ADAPTIVE START CONTROL

Learning from the previous heating cycle enables the appliance to judge the appropriate advance time to turn on the heater to ensure that the set temperature is reached at the set time. For example, if your timer is set to start at 18:00 and temperature is set to 23°C, the fire may for example come on at 17:30 to ensure the room is 23°C at 18:00.



RESETTING THE THERMAL CUT OUT

1. The appliance is fitted with an Electronic Safety Control (E.S.). This is a safety device, which switches off the fire if, for any reason, the appliance overheats, e.g. when covered. If the heater stops operating while the flame effect continues working normally, this indicates that the E.S. Control is in operation. The E.S. Control can only be re-set after the appliance has cooled down, and the appliance has been reset. Resetting of the E.S. Control proceeds as follows:
2. Press button STAND BY on the appliance to turn it off and leave it off for approximately 10-15 minutes.
3. Remove any obstruction to the fan heater outlet or fan blades etc. Make sure that the power supply is disconnected with the plug socket outlet while doing this.
4. Switch on the appliance and the E.S. Control will be reset.
5. Ensure that the appliance is functioning correctly. If the E.S. Control operates again, the appliance should be checked by a competent electrician.







- A heater has hot and arcing or sparking parts inside. Do not use it in areas where gasoline, paint, or flammable liquids are used or stored.
- Use this heater only as described in this manual. Any other use not recommended by the manufacturer may cause fire, electric shock, or injury to persons.
- Always plug heaters directly into a wall outlet/receptacle. Never use with an extension cord or relocatable power tap (outlet/power strip).
- This heater may include an audible (a visual) alarm to warn that parts of the heater are getting excessively hot. If the alarm sounds (flashes), immediately turn the heater off and inspect for any objects on or adjacent to the heater that may cause high temperatures. **DO NOT OPERATE THE HEATER WITH THE ALARM SOUNDING (FLASHING).**
- Hyperthermia can result in death. Symptoms of hyperthermia include high body temperature, headache, nausea, vomiting, tiredness, dizziness, fainting, and rapid pulse. If you begin to experience symptoms related to hyperthermia, turn off the heater and seek medical attention.
- To avoid excessive room temperatures which can cause hyperthermia: **DO NOT** leave product running unattended in a confined space around infants, or individuals with reduced physical, sensory, or mental capabilities.
- **DO NOT** place the heater near a bed because objects such as pillows or blankets can fall off the bed and be ignited by the heater.
- **AVOID FIRE!** Regularly inspect all air vents to make sure they are free from dust, lint, or other blockage. Unplug the unit and clean with a vacuum **ONLY**. **DO NOT** rinse or get wet.
- **WARNING: REDUCE THE RISK OF FIRE OR ELECTRIC SHOCK---DO NOT USE THIS HEATER WITH ANY SOLID STATE SPEED CONTROL DEVICES.**

- For residential use only! NOT for commercial use! Any commercial or public use of this heater voids all warranties, and could cause injury.
- This product is not intended to be a primary heat source. It is for supplemental heat only.
- NEVER modify this heater. Doing so could result in personal injury or property damage. Modification of this fireplace completely voids all warranties.
- ALWAYS disconnect this unit from the power supply before performing any assembly or cleaning, or before relocating the electric fireplace.
- NEVER leave this heater unattended. ALWAYS unplug this heater when not in use.
- ALWAYS store this heater in a dry location. NEVER use the fireplace if it has become wet.
- ONLY use this heater on a 120V AC 15-Amp circuit. NEVER overload the circuit. If this heater trips the circuit breaker, unplug all other appliances on the same circuit before the next use. Avoid plugging other appliances into the same circuit as this heater.
- NEVER plug this heater into an outlet that is old, cracked, or has any loose wires or connections. Plugging this heater into a faulty outlet could result in electric arcing within the outlet that could cause the outlet to overheat or catch fire.
- ALWAYS check your heater cord and plug connections with each use! MAKE SURE the plug fits tight in the outlet! Faulty wall outlet connections or loose plugs can cause the outlet to overheat.









SAVE THESE INSTRUCTIONS!







	TIMER	Set the time desired for the fireplace to run. The timer can be set from 0.5 hour up to nine (9) hours in one (1) hour increments.	30, 1H, 2H, 3H, 4H, 5H, 6H, 7H, 8H, 9H, 0H
	TIME	Press to set up the heating start and end time under 7 days timer; Keep press to set current time.	The number shows on the display.

SET UP CURRENT DAY AND TIME

Hold time button  on the remote to enter date and time setting mode; Repeatedly press time button  to select date, D1-D7 will show on the display which represents Monday-Sunday. Press button  to confirm, and then automatically enter hour setting. Press button  to set the hour, and press button  to save and then automatically enter minute setting. Press button  again to set minute and then press  to save.

SET UP 7 DAYS TIMER

- Hold the button  on the remote until the 7 days timer indicator on the firebox flashes to enter 7 days timer setting mode.
- D1 (Monday) will show on the display and then press  to confirm; then 00 will show on the display. Press button  to set the time for turning on the heater and then press  to confirm; The 00 will show on the display, press  to set the time for turning off the heater and then press  to confirm. **PLEASE NOTE: There is only one period each day for heating on and off.**
- Repeat the steps above to set the timer for D2 to D7 (Tuesday to Sunday). The display on fire will show the time for turning on and off the heater as same as the time of last day. If you want to change the time, press the button .
- If you don't want to set for a certain day, just set both start and end time as 00.
- Hold 7 days timer button  to save all settings after you finish the setting for Sunday. The indicator will stop to flash.
- The weekly timer will be set only when you finish the setting from Monday to Sunday completely. During the setting process, the pause of more than 20 seconds will terminate the entire weekly timer setting.

Icon	Title	Function	Fireplace Response
	STANDY-BY	Press to turn on /off the flame effects and heater.	Turn on:F1,...F9 ,F0 Turn off: no display
	FLAME	Cycle through 9 flame colours and off setting.	F1, F2,...F9,F0
	BRIGHTNESS	Cycle through 5 settings of brightness of flame and fuel bed.	L5, L4,L3,L2,L1,L0.
	HEATING	Cycle through low heater, high heater and off setting.	Lo=low heat setting HI=high heat setting The heater indicator will turn off after 10 seconds if the flame effect is on
	TEMPERATURE	Adjust the heaters response to the ambient temperature conditions in the room. Temperature adjusts from 16 °C - 28 °C (60 °F - 84 °F) and then 58°F (99°F). Hold for 3 seconds to switch between °C/°F.	16,17,18,19,20,21,22,23,24,25,26,27,28,58 in Celsius degree 60,62,64,66,68,70,72,74,76,78,80,82,84,99 in Fahrenheit degree.
	7 DAYS TIMER	Press to Turn on/off 7 days timer; Keep press to start the setting for 7 days timer.	Indicator lights on

IMPORTANT NOTICE

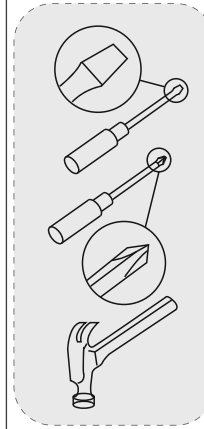

- This product contains small components, please ensure that they are kept away from small children.
- THIS INSTRUCTIONS CONTAINS IMPORTANT SAFETY INFORMATION. PLEASE READ BEFORE ASSEMBLY AND KEEP FOR FUTURE REFERENCE.
- Read each step carefully. It is very important that each step of instruction is performed in the correct order. If these steps are not followed in sequence, assembly difficulties will occur.
- Make sure all parts are included. Most parts are labeled or stamped on the raw edge.
- Work in spacious area, preferably on a carpet, near the place the unit will be used.
- Do not use power tools to assemble your furniture. Power tools may strip or damage the parts.
- Move your new furniture carefully, with two people lift and carry the unit to its new location.
- Never push, drag or pull your furniture (especially on carpet).

PLEASE DO NOT RETURN PRODUCT TO US IMMEDIATELY

- If any parts are missing or damaged, do not return the damaged item to your dealer, contact Customer Service. We will gladly ship you replacement parts FREE of charge!
- Need Parts or Assistance? Email us at riching@nbrehome.com
- Thank you for choosing our products.
- For Prompt, Reliable Customer Service, Please have your assemble instruction ready.



WARNING (Death or serious injury may occur when children climb on audio and/or video equipment furniture.)

To reduce the risk of furniture tipover:



- NEVER attempt to move this furniture without first removing all equipment.
- NEVER placing remote control or toys on the furniture, may encourage a child to climb on the furniture and as a result the furniture may tip over onto the child.
- Please contact us using the details shown for further advice

TECHNICAL SPECIFICATIONS

MODEL NO.: AK0001(EF529A)/AK0002(EF530A)







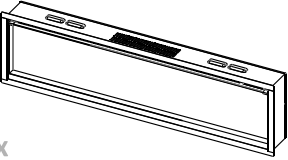

Supply Voltage: AC 120 V 60Hz

Maximum power consumption: 1.5 KW

Power for flame and fuel bed effect: 11 w/11 w

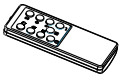
PARTS

- Unpack the fire carefully, make sure that the appliance is intact with no signs of damage caused by transport and no part has been exposed to water. If in doubt, do not use the appliance and contact an authorized service center.
- Keep plastic wrapping away from children.
- Save the original packaging as this may be required in the event of service complaint with product.
- Check that all parts are removed from the packaging.

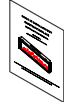
<p>A.</p>  <p>1x</p>	<p>B.</p>  <p>4x</p>	<p>C.</p>  <p>4x</p>	<p>D.</p>  <p>4x</p>	
Fireplace		Rubber Feet	Screw ST4*8	Screw ST4*12
<p>E.</p>  <p>1x</p>	<p>F.</p>  <p>2x</p>	<p>G.</p>  <p>1x</p>	<p>H.</p>  <p>1x</p>	<p>I.</p>  <p>1x</p>
Remote	Battery	Log Set	Crystal	Manual

- 1. STAND-BY:** Turns on the appliance with the last used settings including heater. Place the appliance into standby mode with all features turned off.
- 2. FLAME:** Press to cycle through 9 flame colours and off setting.
- 3. HEATER:** Press to cycle through low heater, high heater and off setting.
- 4. TEMPERATURE:** Press to adjust the heaters response to the ambient temperature conditions in the room. Temperature adjusts from 16 °C - 28 °C (60 °F - 84 °F) and then 58°C (99°F).

NOTE:

- The manual button controls basic functions, not a full range of controls. Use the remote handset to carry out all functions.
- In order to prevent the product becoming too hot, there is a 10s delay when turning on the heater and a 10s delay when turning off the heater fan.

REMOTE CONTROL

NOTE:

- Ensure that the handset batteries are new and inserted correctly.
- Aim the remote control at the remote receiver which is behind the right side of the flame screen.

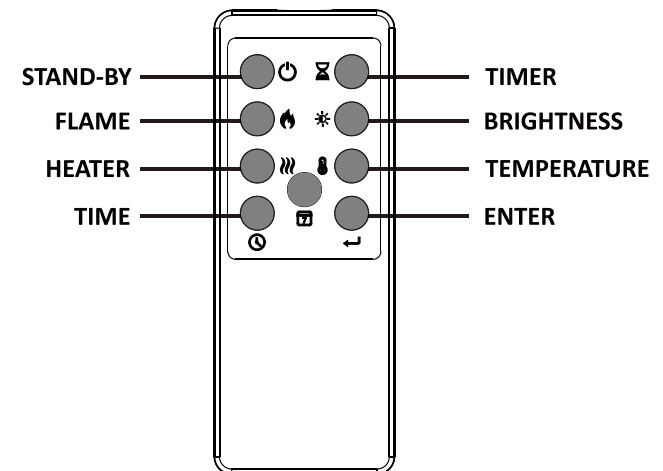

OPERATING INSTRUCTION

BEFORE OPERATION

WARNING! Do not operate the appliance if it is damaged or has mal-functioned. If you suspect the appliance is damaged or has malfunctioned, call a qualified service engineer to inspect the appliance, and replace any part of the electrical system if necessary, before re-use.

WARNING! To reduce the risk of fire, keep textiles, curtains, or any other flammable material a minimum distance of 3 feet from the air outlet.

- MAKE SURE the plug fits tight in the outlet. Faulty wall outlet connections or loose plugs can cause the outlet to overheat.
- DO NOT disconnect the power at the mains supply whilst the appliance is running. Use the functions on the remote to turn the fire off and ensure the mains switch has been moved to the off position before disconnecting.

OPERATION METHOD

- The appliance can be operated conveniently in 2 different ways: manually or via the remote control handset.

MANUAL CONTROL

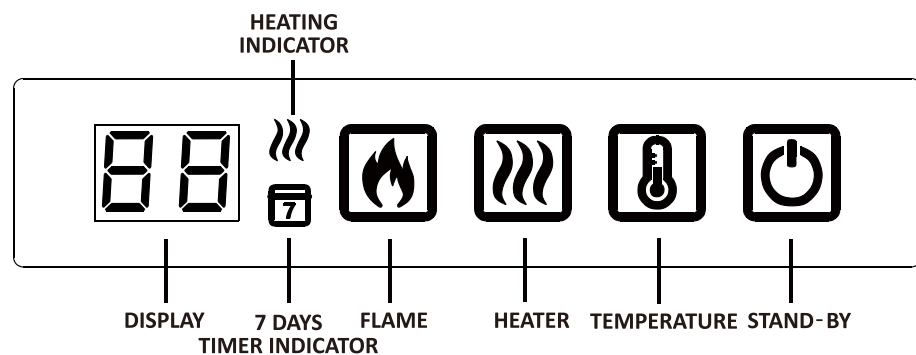

APPLIANCE DIMENSIONS

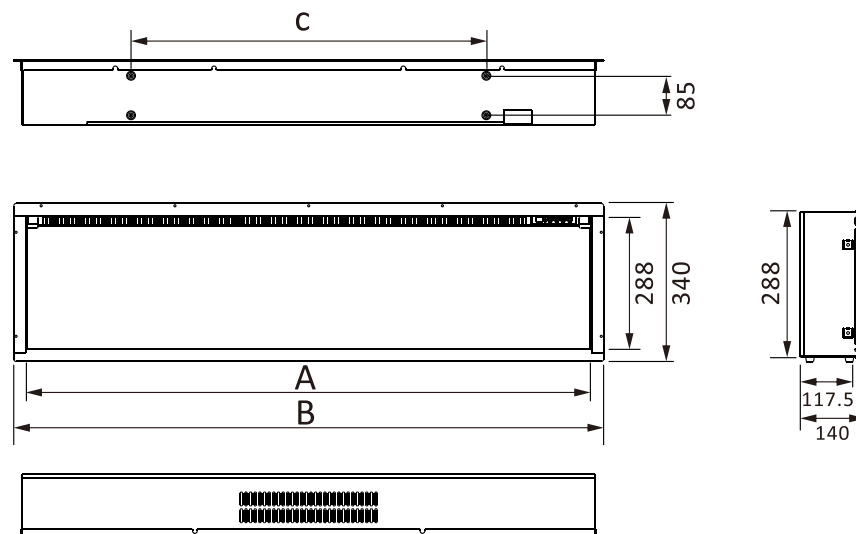

Model	Unit	A	B	C
Ak0001	Inch	47 ⁶¹ / ₆₄	50	30 ¹ / ₈
	mm	1218	1270	765
Ak0002	Inch	58	60	40 ⁵ / ₃₂
	mm	1473	1525	1020

INSTALLATION INSTRUCTIONS

- Remove 2 screws and 2 glass holder. (Not necessary to install it back after removing.)

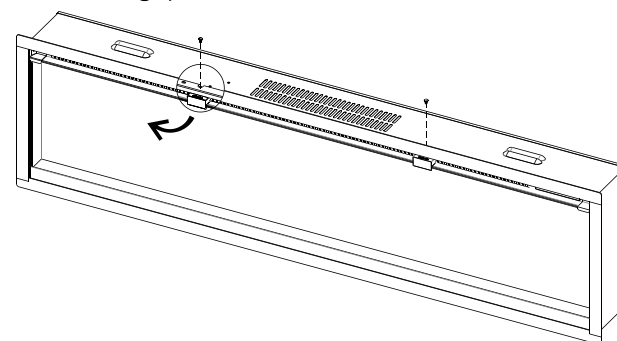

- Fix the rubber feet (Part B) on the bottom panel with four 4*8 screws (Part C).

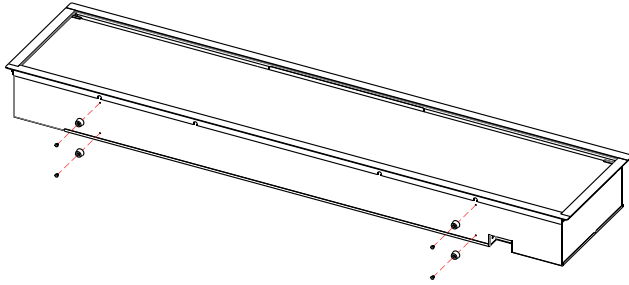

- Push the firebox into the fireplace wood mantel.

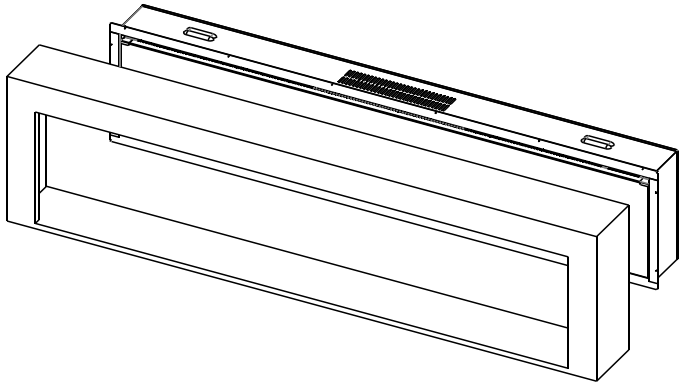

- Tape the firebox to the inside of the fireplace wood mantel with 4x ST4*12 screws (Part D).

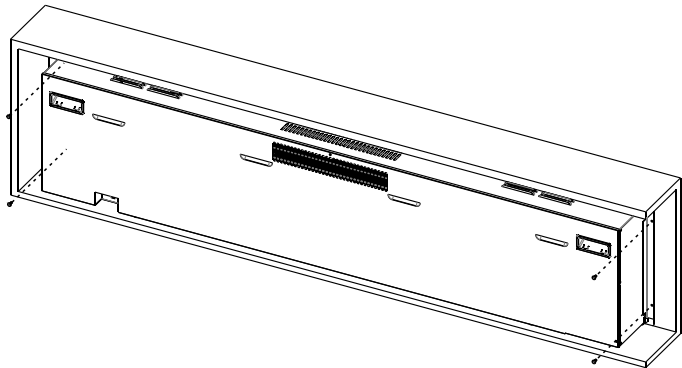

- Remove 2 screws and 2 brackets on both side.

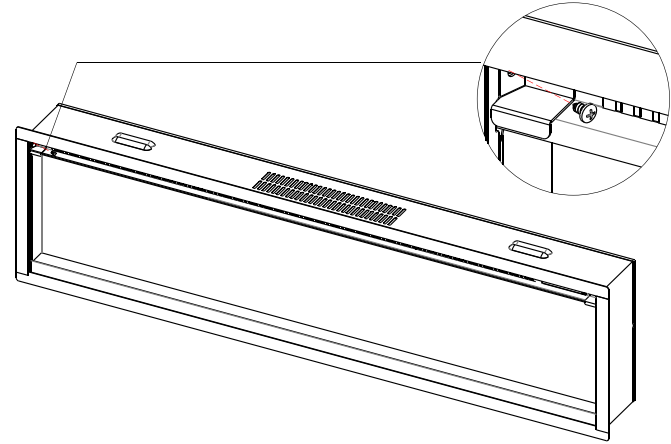

- Take off the glass and put it in safe place.

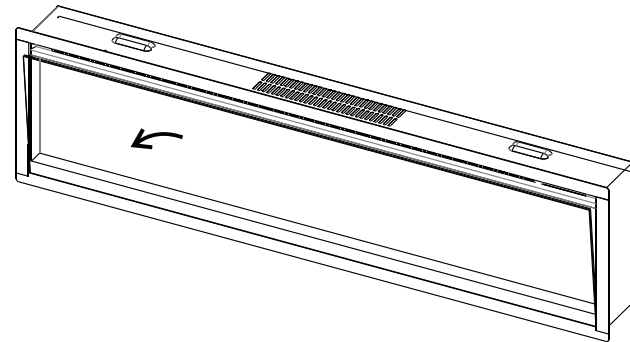

- Evenly scatter the crystal (Part H) on the fuel bed then put on the logs (Part G). Then fix the 2 screws and 2 brackets back on both side.

