

















# ASSEMBLY INSTRUCTIONS

NO.	Parts List		Q' TY
A		Chair Back	1
B		Upholstered Seat with Frame	1
C		Left Front Leg	1
D		Right Front Leg	1
E		Left Side Stretcher	1
F		Right Side Stretcher	1

NO.	Parts List		Q' TY
1		1/4" x 3 1/8 Allen Bolts	4
2		1/4" x 2" Allen Bolts	4
3		1/4" x 1 9/16 Allen Bolts	2
4		14 mm x 1.5 mm Lock Washers	10
5		22 mm x 1.5 mm Flat Washers	10
6		1/6" x 3" Allen Key	1
7		1/6" x 1 3/4 Wood Screws	4
8		Glue	1
Tools Required (Not Included)			
		Phillips Head Screwdriver	1

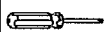
**Important Note**  
Do not use power tool for assembly  
All bolts must fasten either by Wrench or Allen Key.



## STEP 2 Do not fully tighten the bolt

### STEP 1

Do not fully tighten the bolt

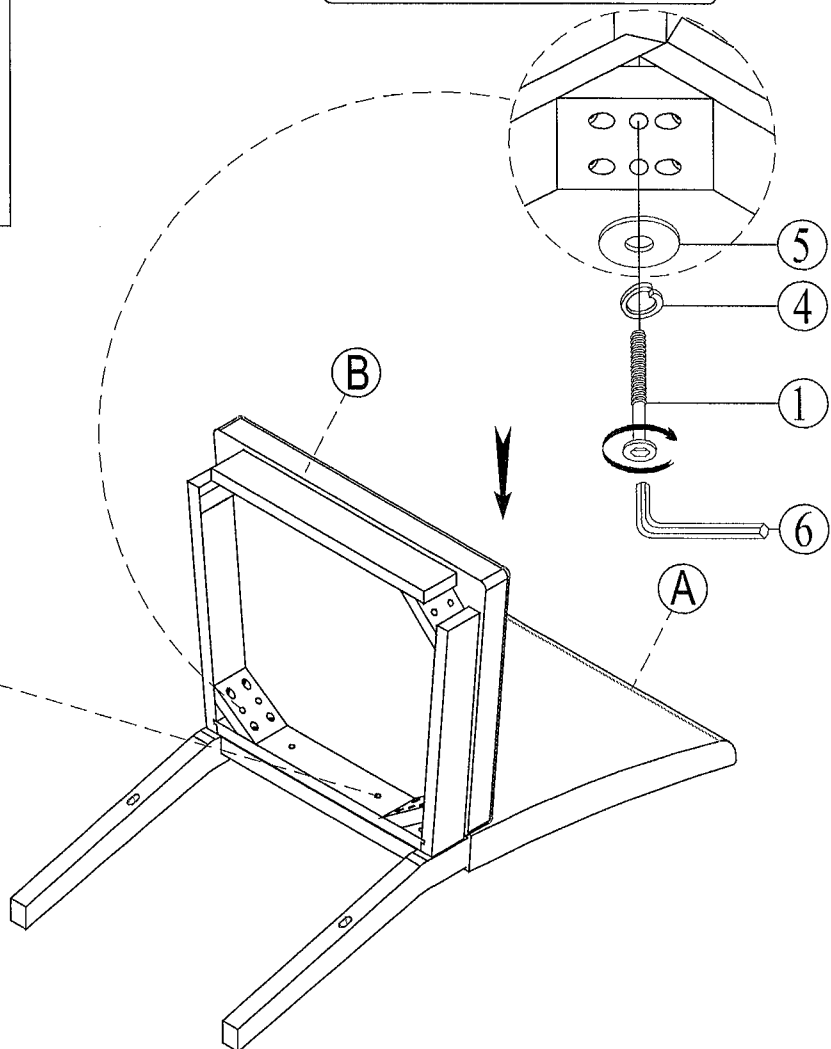
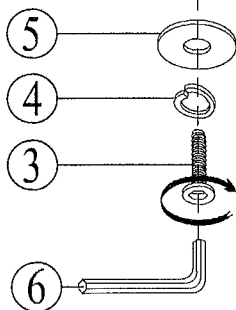
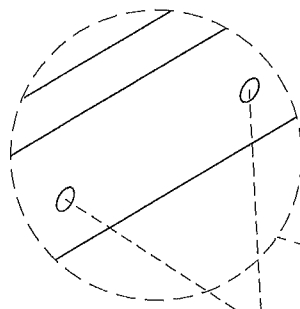

## STEP 4

Do not fully tighten the bolt

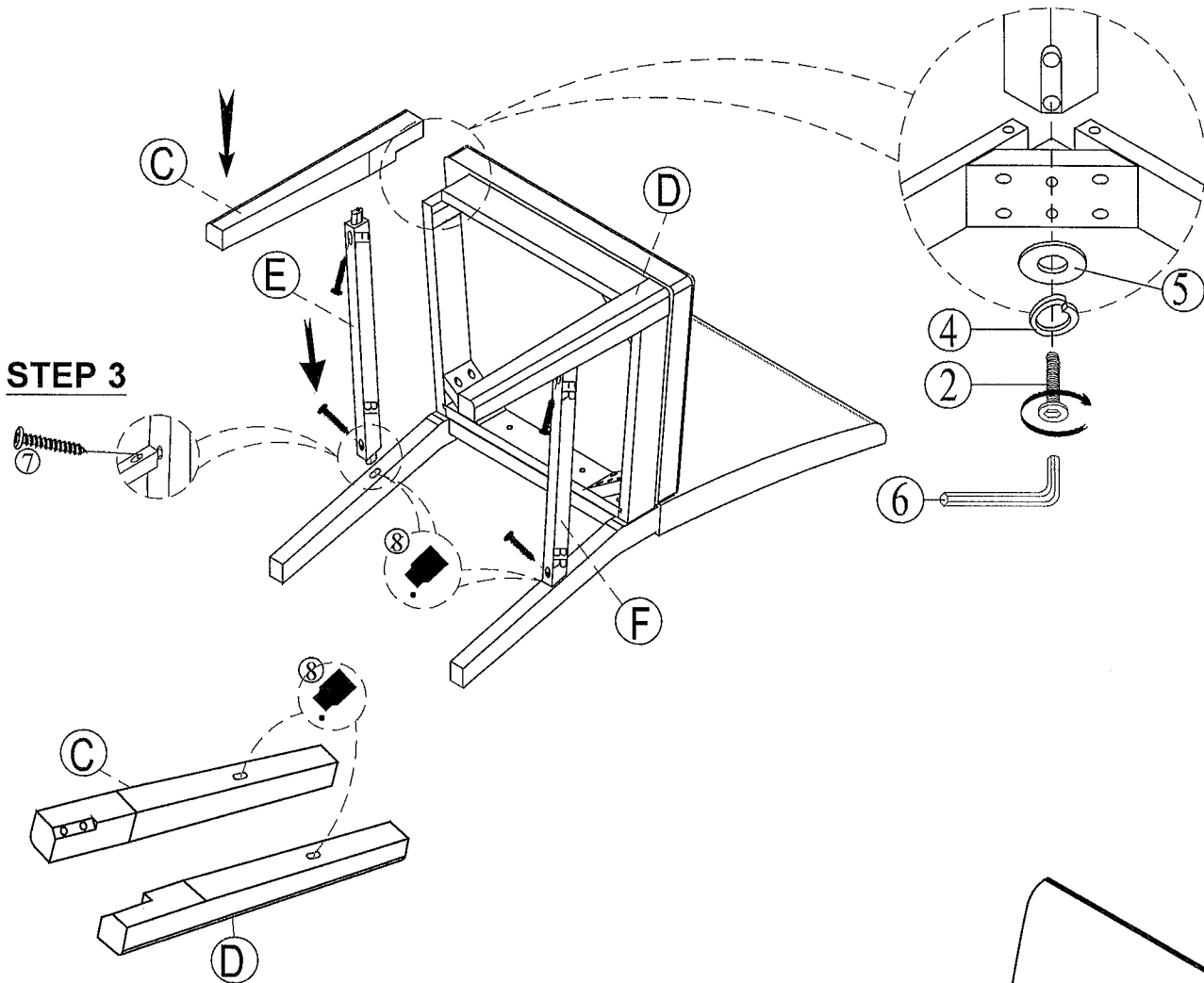

## STEP 3

Levelling solution: Loosen each bolt in the seat box (front leg, back corner blocks and back apron) to the point where it can be turned with our fingers. Place the Chair/Stool upright on the floor and make sure Chair/Stool back and seat frame are well connected. Sit in the Chair/Stool, but do not lean against the Chair/Stool back. Gently sway back and forth, left and right. Carefully turn the Chair/Stool upside down, and tighten each bolt. The Chair/ Stool will now be levelled.

