

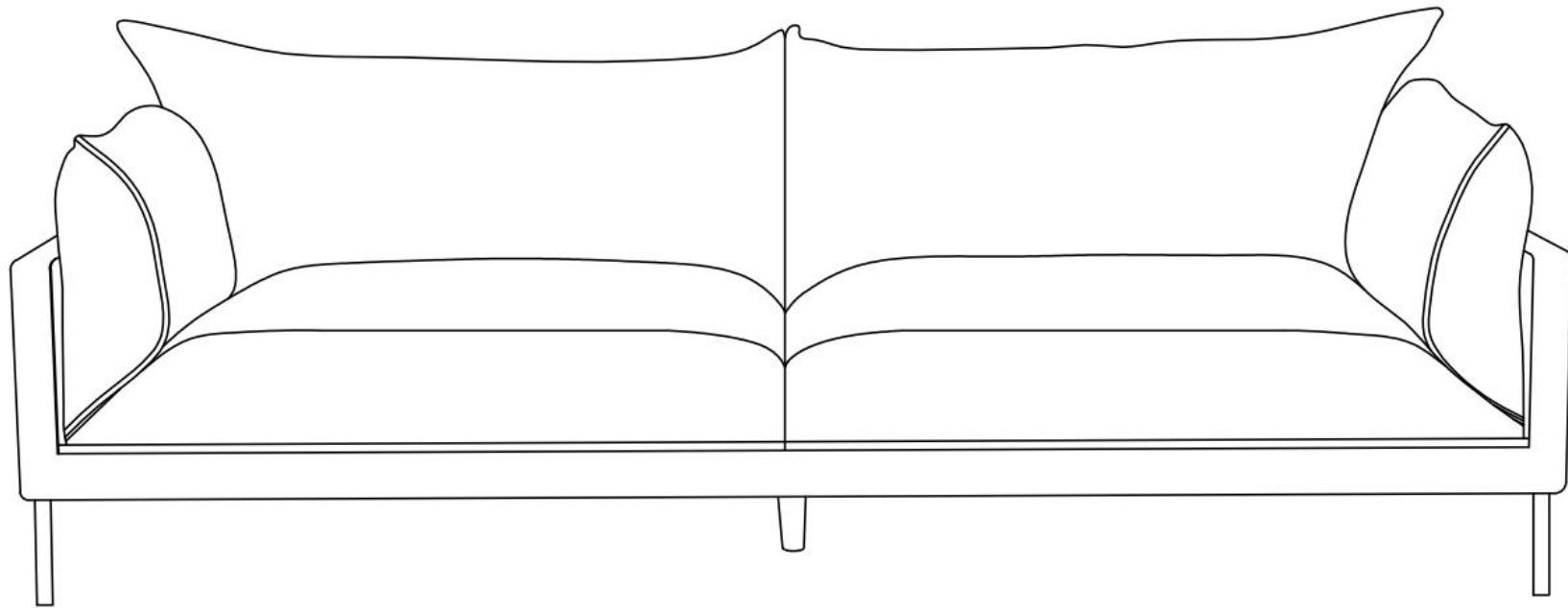



ASSEMBLY INSTRUCTIONS.

JAMARA SOFA BURNT AUBURN

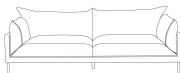

THANK YOU FOR YOUR PURCHASE!

PARTS AND HARDWARE.

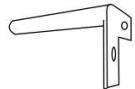
No.	Description	IMAGE	QTY
P1	sofa		1
P2	Middle leg		1
P3	SCREW		8
P4	Flat		8
P5	Wrench		1
P6	Metal leg		4

NOTES.

Thank you for purchasing this quality product! Be sure to check all packing material carefully for small part that may have come loose inside the carton during shipping.

CAUTION: The item is heavy, assembly should be performed by two people.

STEP 1.

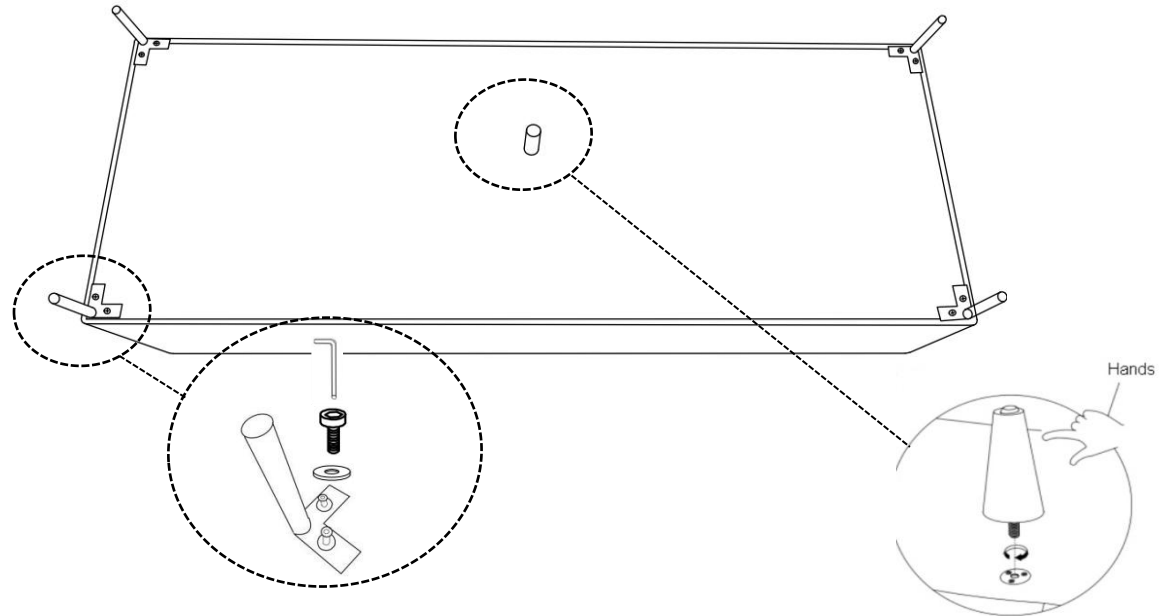

STEP 2.

