

ASSEMBLY INSTRUCTIONS

TWIN SIZE BED

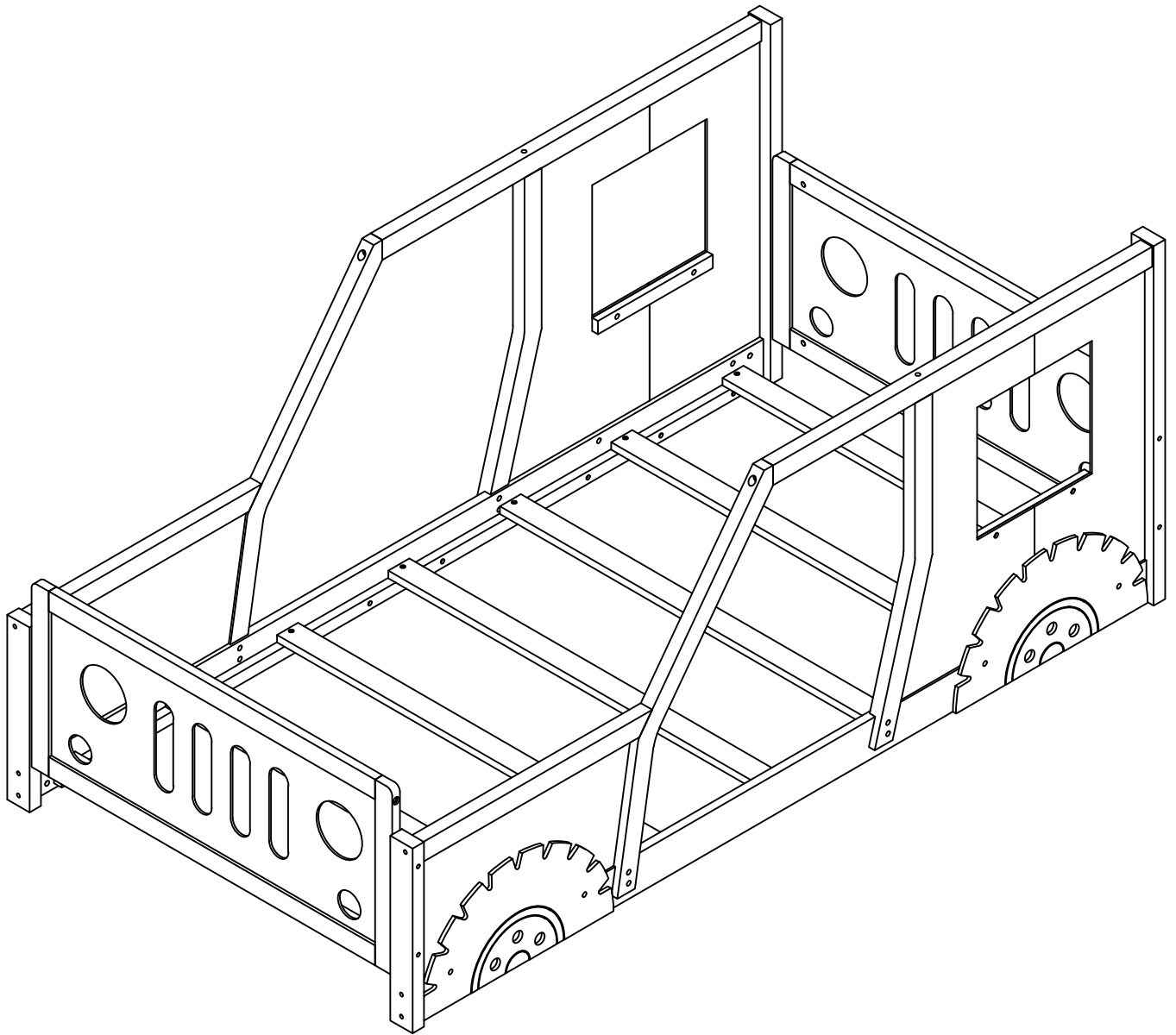

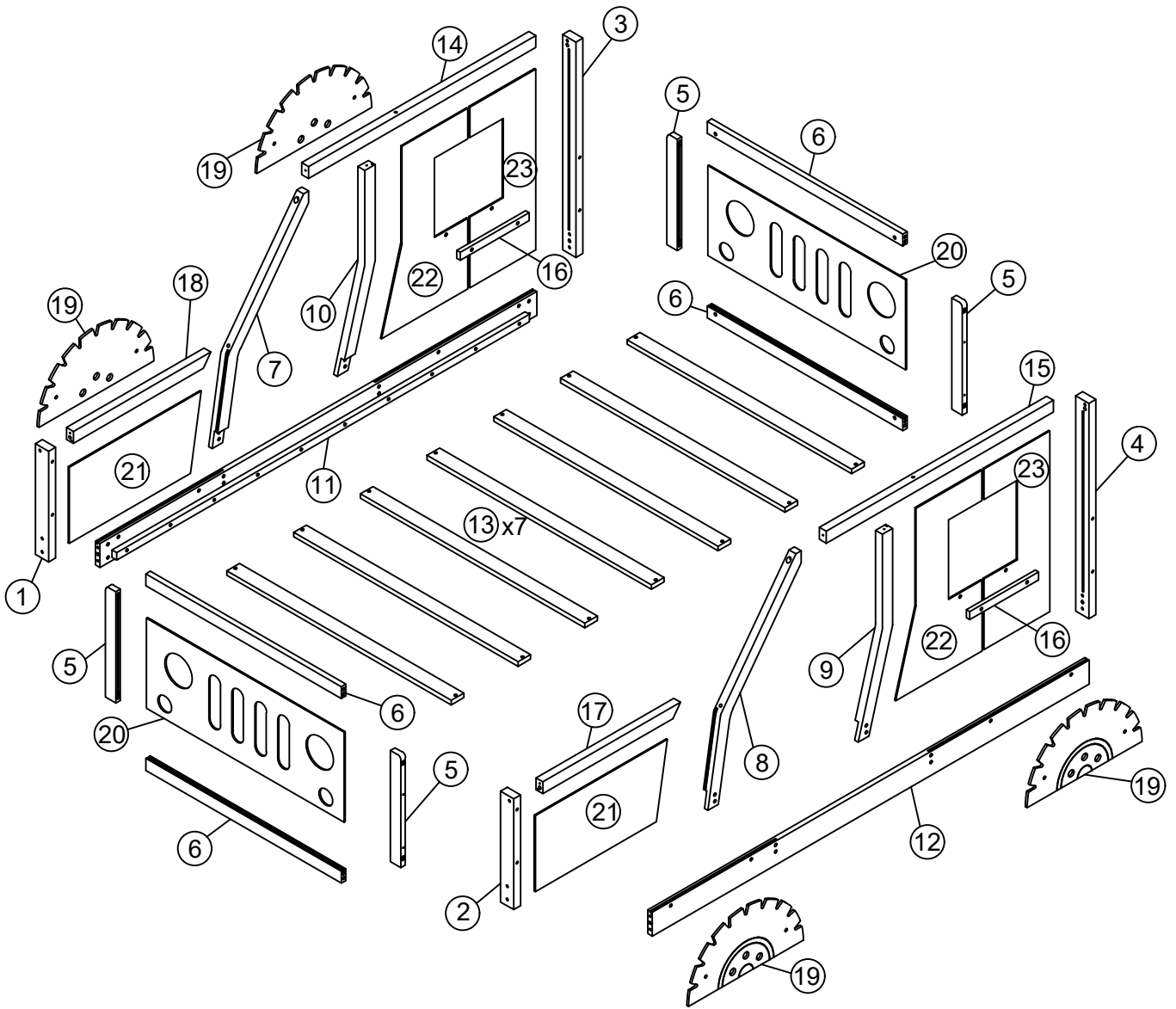









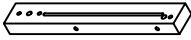
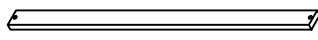

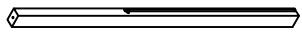

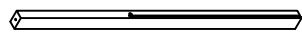
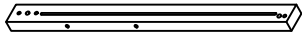
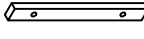

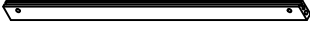
ASSEMBLY INSTRUCTIONS



ASSEMBLY INSTRUCTIONS

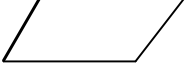

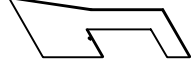

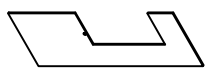
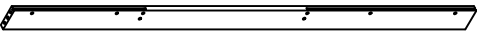





PARTS LIST

(Hardware in this SKU)

1	 Left rear foot of bed	1pc	13	 Slats	7pcs
2	 Left front foot of bed	1pc	14	 Frames side rail	1pcs
3	 Right rear foot of bed	1pc	15	 Frames side rail	1pcs
4	 Right front foot of bed	1pc	16	 Wooden support bar	2pcs
5	 Bed frame stand	4pcs	17	 Frames side rail	1pc
6	 Bed frame crossbar	4pcs	18	 Frames side rail	1pc
7	 Frame left side rail	1pc	19	 Wheel plank	4pcs
8	 Frame right side rail	1pc	20	 Bed headboard	2pcs
9	 Frame right side rail	1pc	21	 Panels side rail	2pcs
10	 Frame left side rail	1pc	22	 Panels side rail	2pcs
11	 Left side rail	1pc	23	 Panels side rail	2pcs
12	 Right side rail	1pc			



ASSEMBLY INSTRUCTIONS

HARDWARE LIST

A	Ø4x30		14PCS	F	1/4x30		8PCS
B	1/4x90		8PCS	G	1/4x20		8PCS
C	1/4x75		8PCS	H	1/4x15		4PCS
D	6.5x60		4PCS	K	10x40		16PCS
E	6.5x80		6PCS	L	4x58		1PC
J	6.5x90		8PCS				

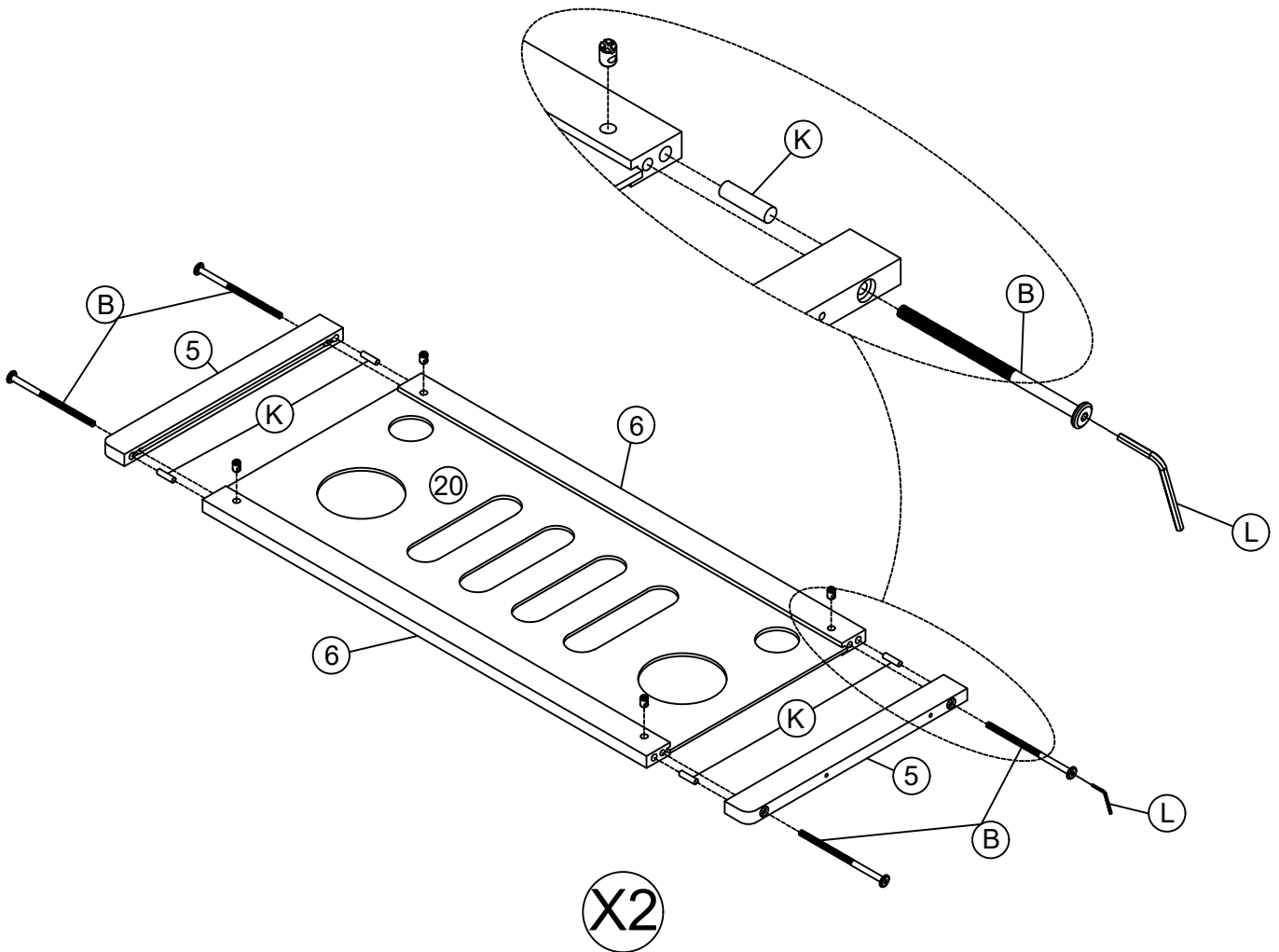
Step 1



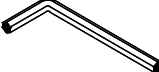

B	1/4x90		8PCS	K	Ø10x40		8PCS	L	4x58		1PC
---	--------	---	------	---	--------	---	------	---	------	---	-----

ASSEMBLY INSTRUCTIONS

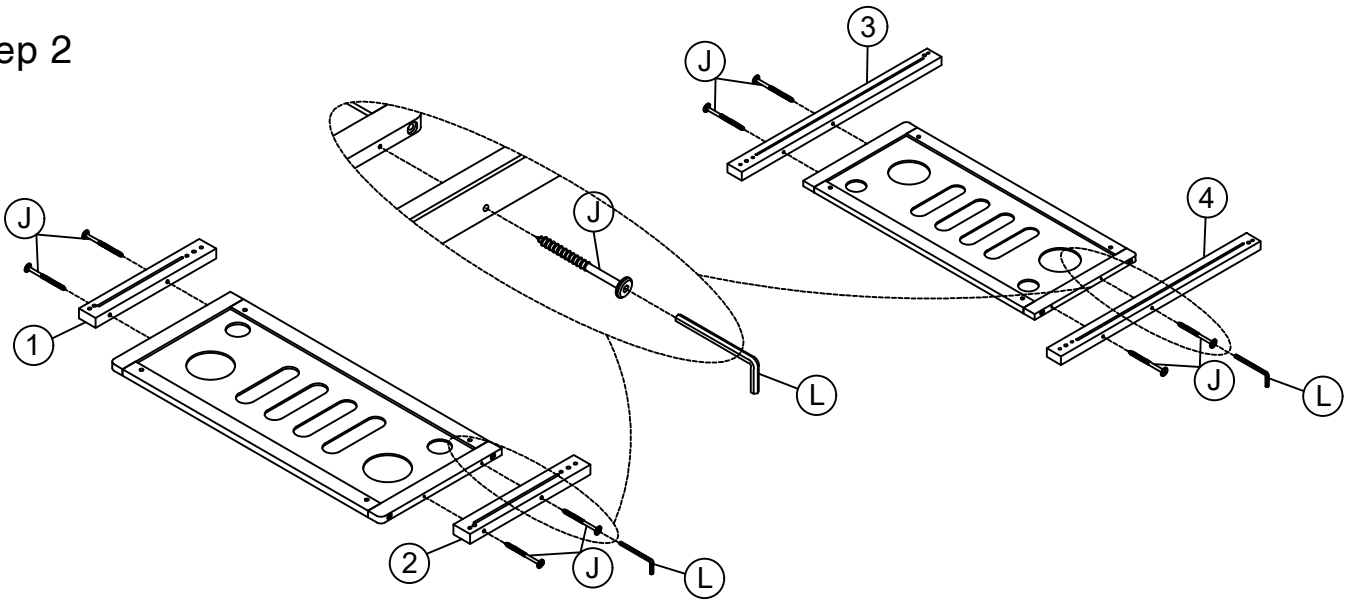

Step 2

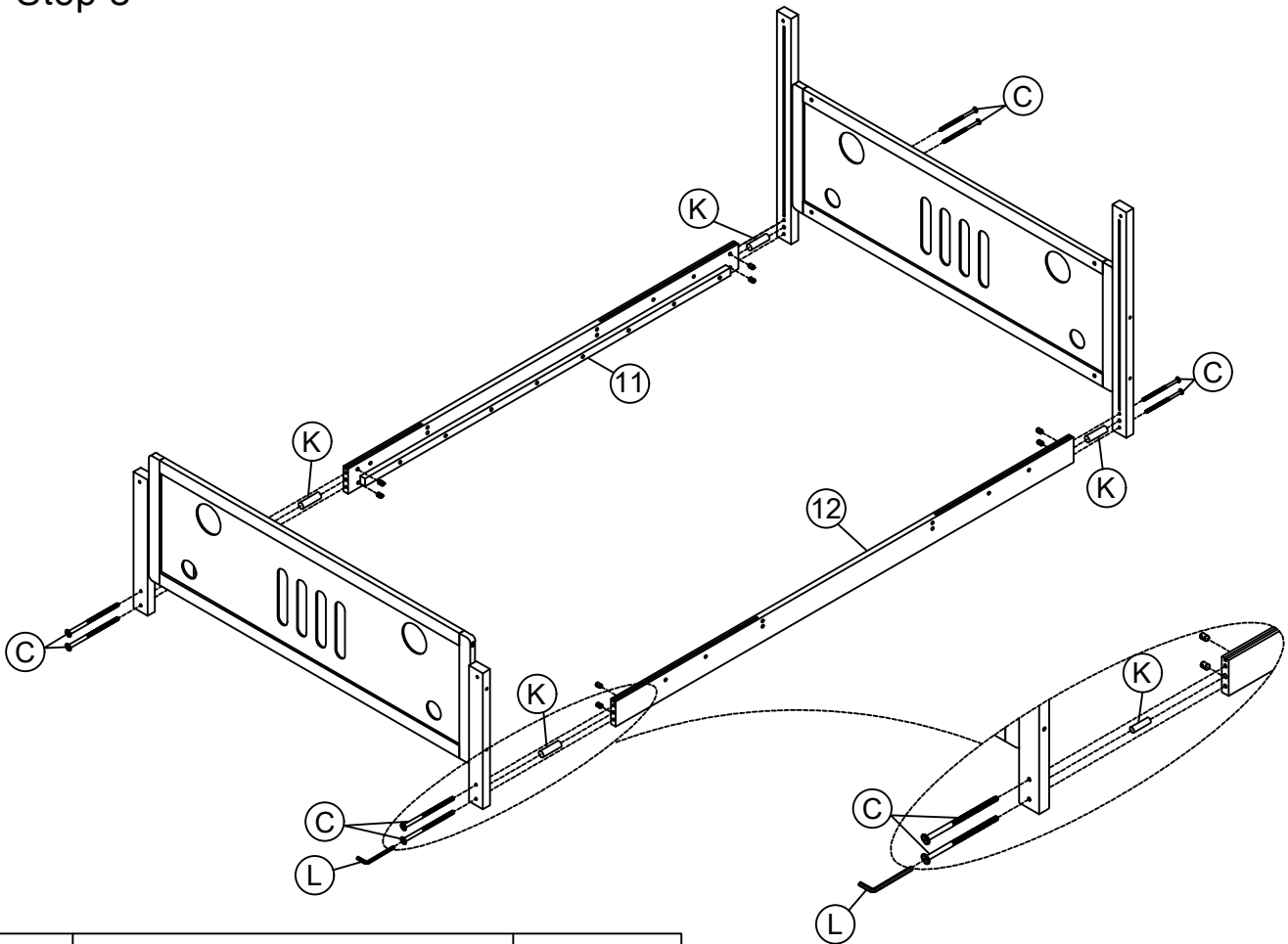

J	6.5x90		8PCS	L	4x58		1PC
---	--------	---	------	---	------	---	-----

Step 3





K	Ø10x40		4PCS	C	1/4x75		8PCS	L	4x58		1PC
---	--------	---	------	---	--------	---	------	---	------	---	-----

ASSEMBLY INSTRUCTIONS

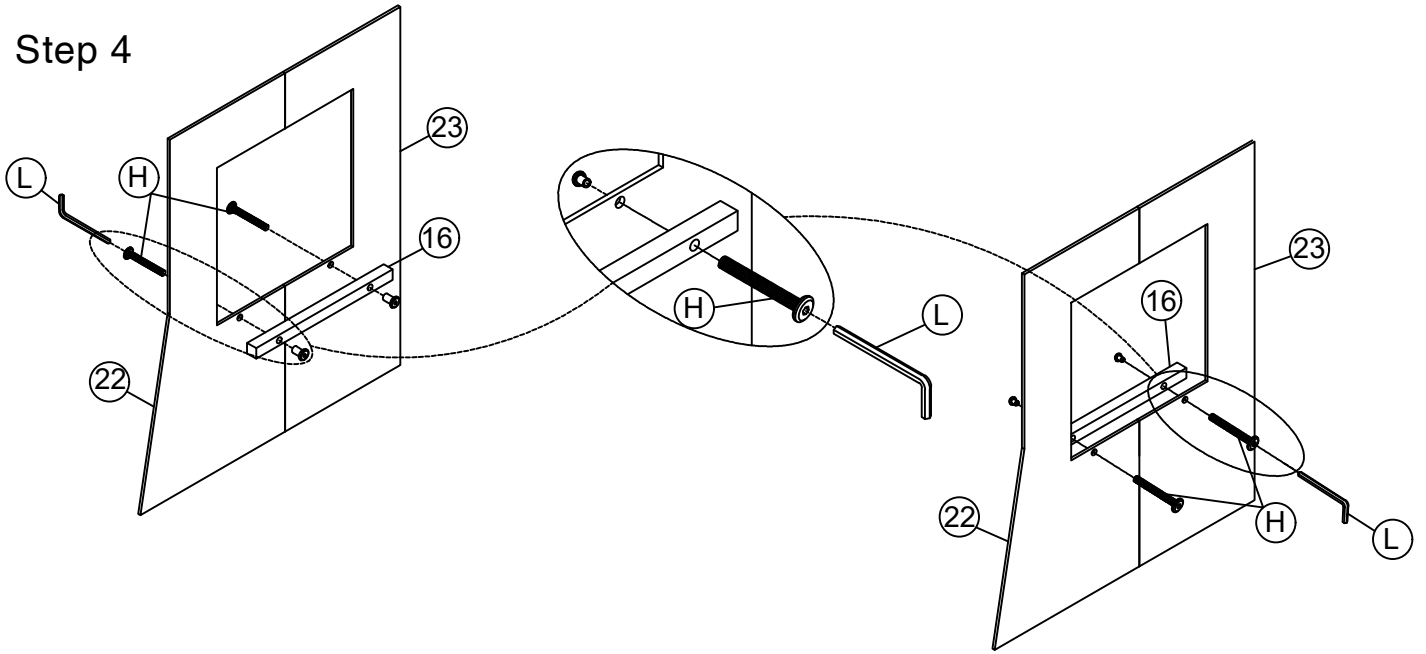

Step 4

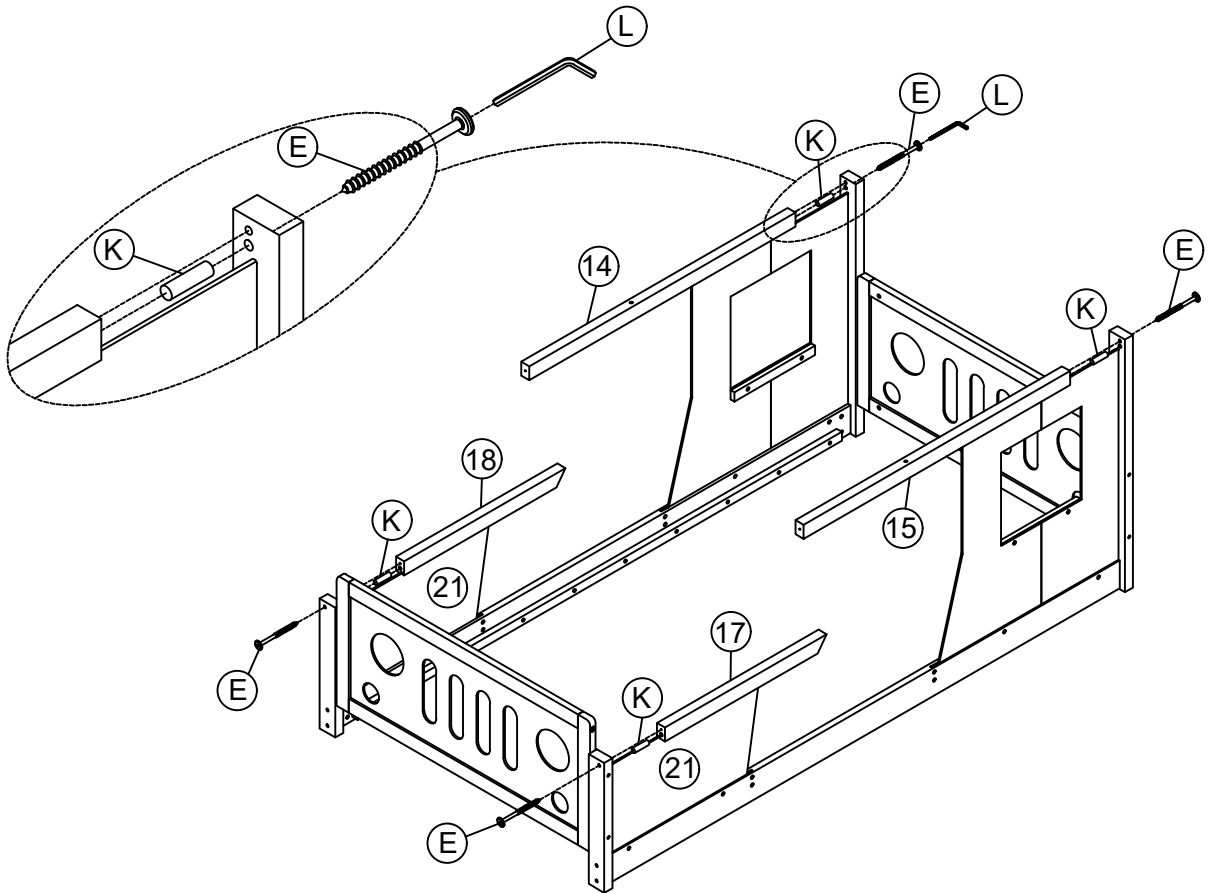

H	1/4x15		4PCS	L	4x58		1PC
---	--------	---	------	---	------	---	-----

Step 5





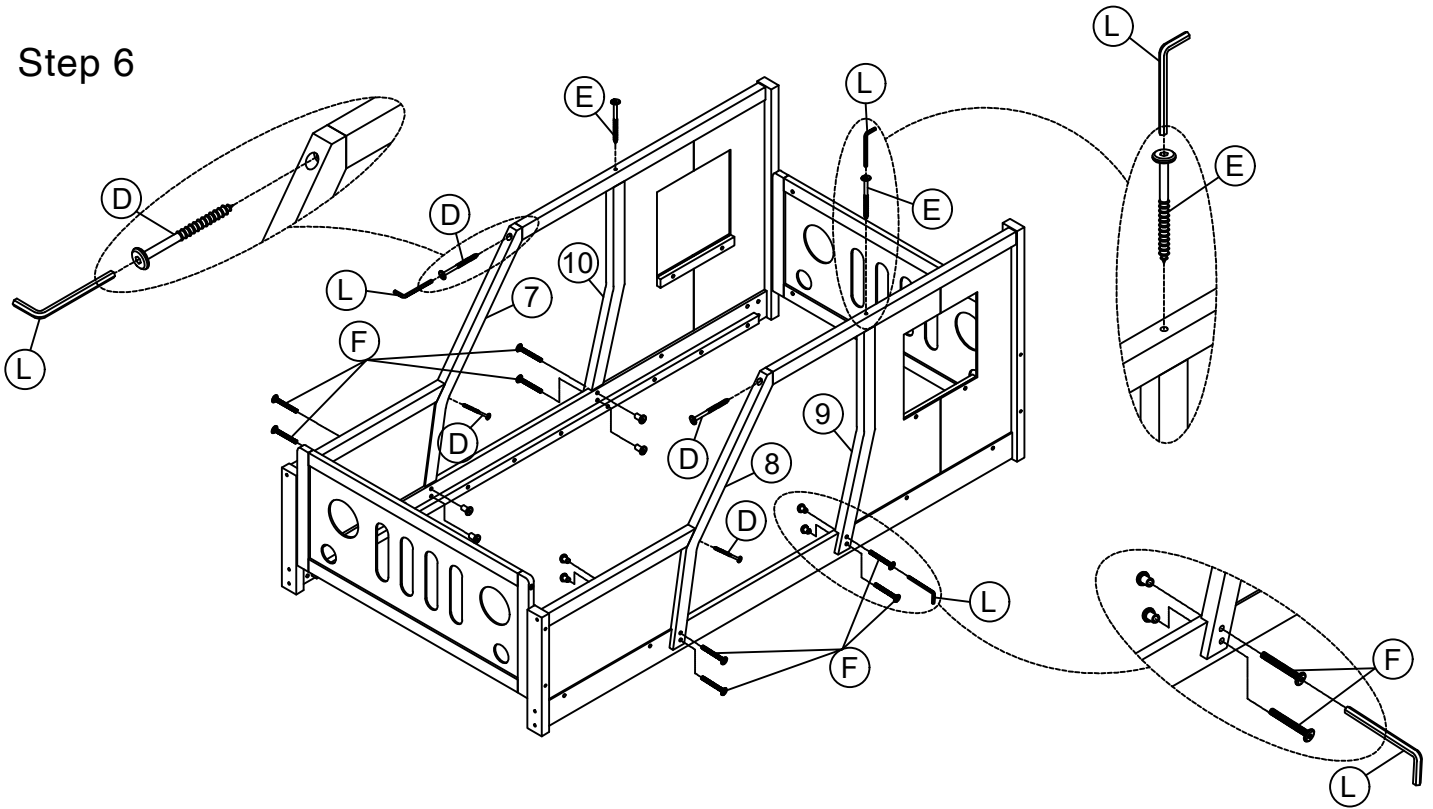

K	Ø10x40		4PCS	E	6.5x80		4PCS	L	4x58		1PC
---	--------	---	------	---	--------	---	------	---	------	---	-----

ASSEMBLY INSTRUCTIONS

Step 6



D	6.5x60		4PCS	F	1/4x30		8PCS
E	6.5x80		2PCS	L	4x58		1PC

Step 7

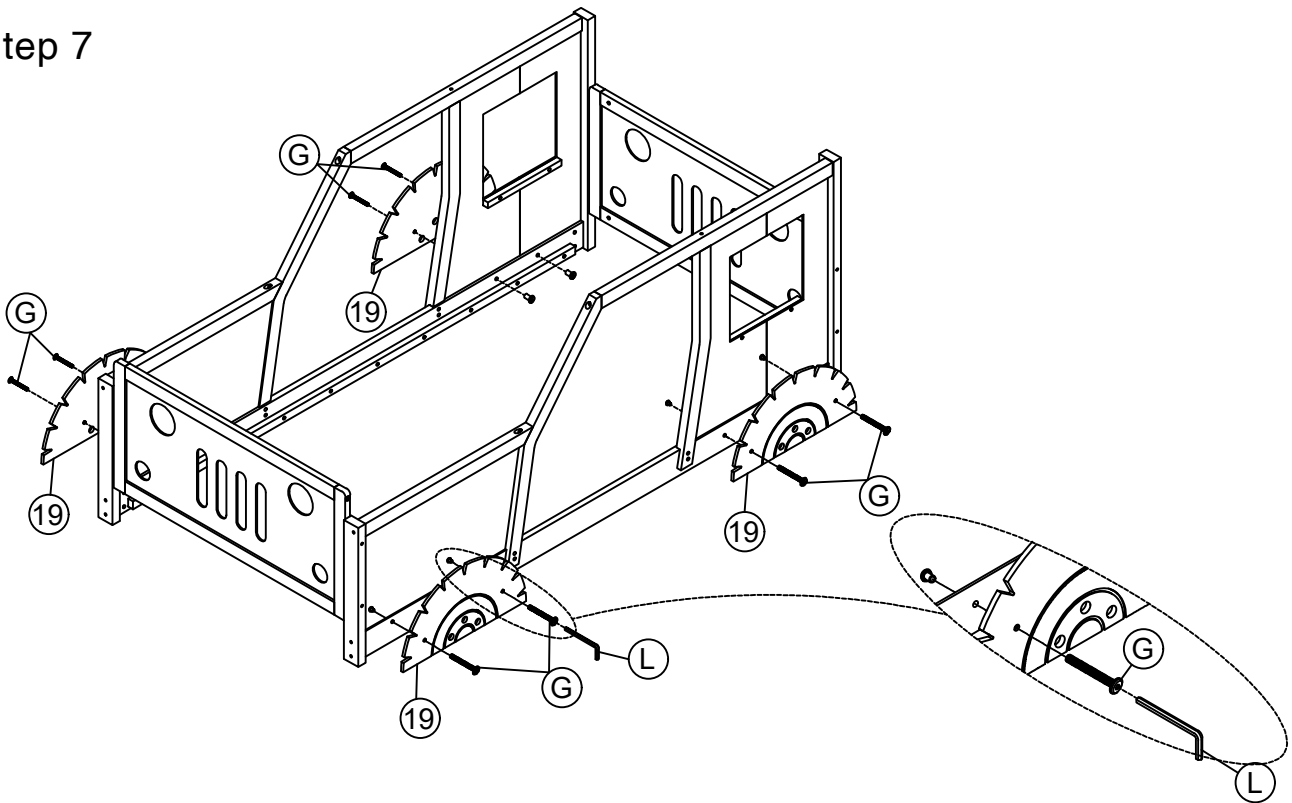

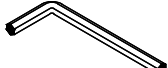
G	1/4x20		8PCS	L	4x58		1PC
---	--------	---	------	---	------	---	-----

ASSEMBLY INSTRUCTIONS

Step 8

First attach 2pcs part 13 to the front and end of the frame between headboard.
Then attach the remaining part 13 equidistantly between headboard

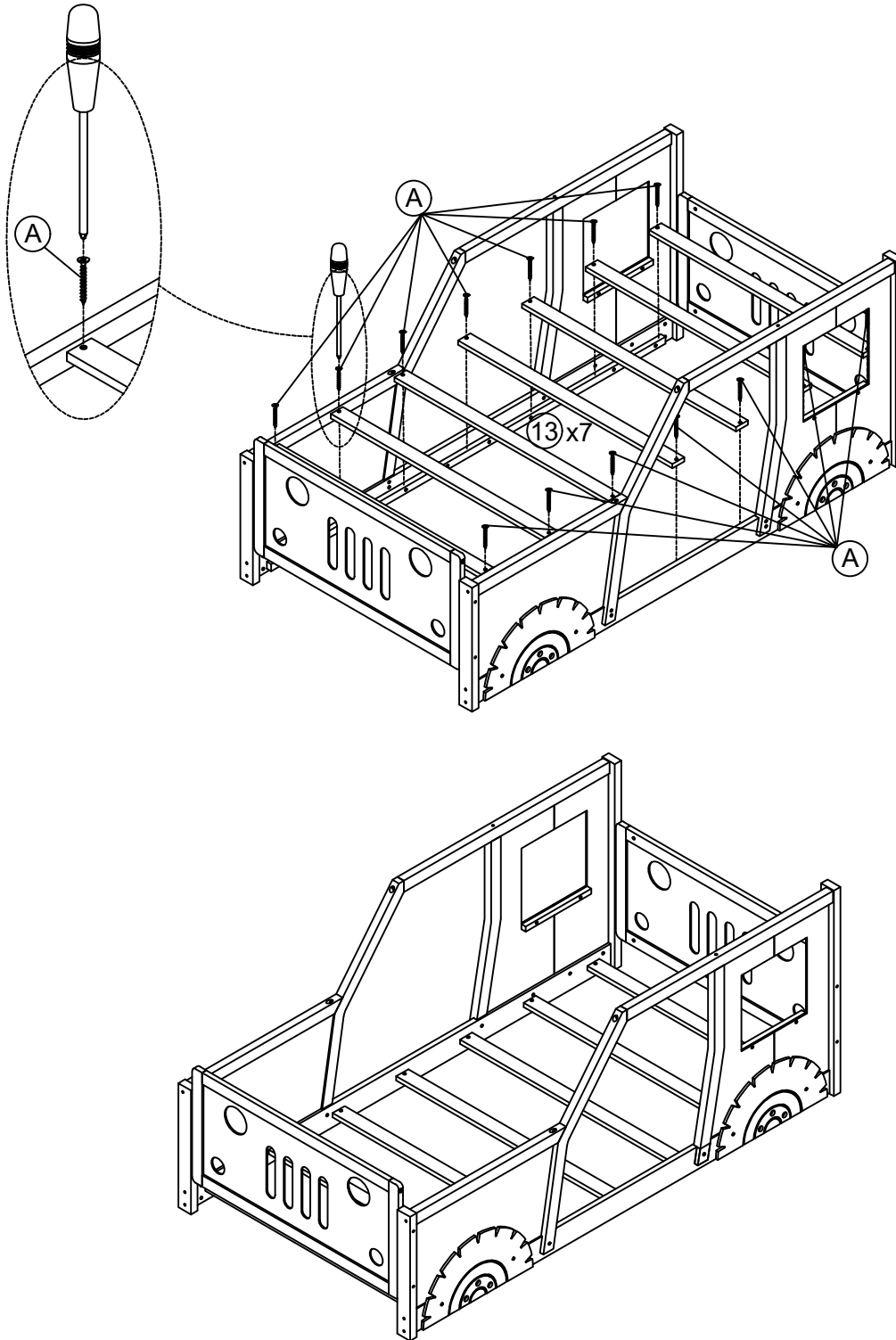

A

Ø4x30



14PCS