

# Serger Techniques

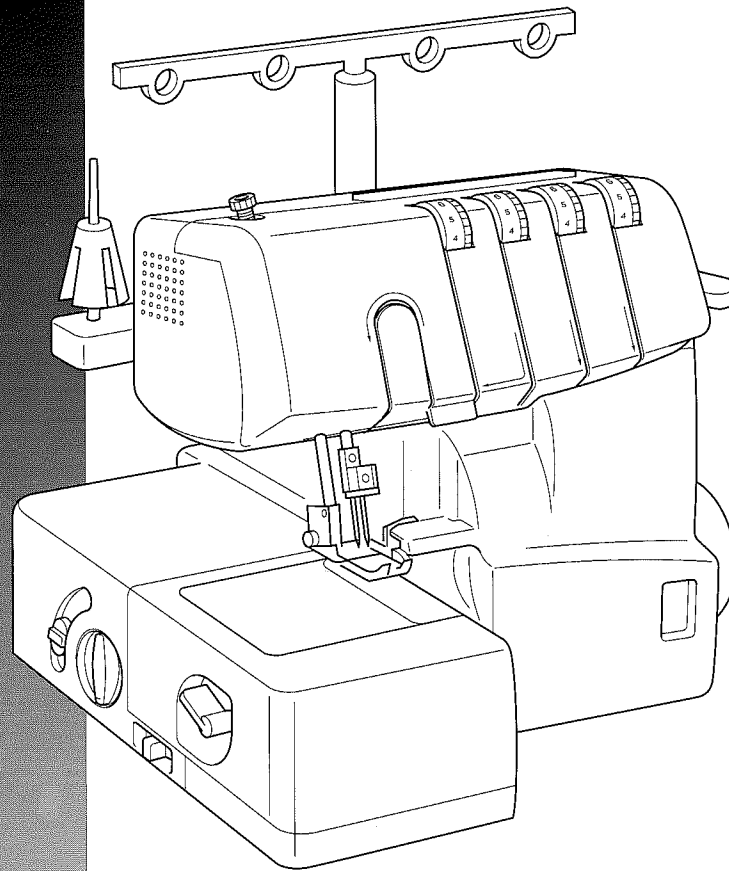

## Table of Contents

Balanced Serger Stitches .....	1	Flatlock Appliqué .....	6
Four-Thread Serging .....	1	Decorative Lace and Tape Application .....	7
Reinforcing Tape Application .....	1	Rolled Edge .....	7
Soft Gathering .....	2	Napkin Finish Rolled Edge .....	8
Three-Thread Serging .....	2	Tablecloth Edging .....	8
Edge Hemming and Finishing .....	2	Formal and Bridal Wear .....	9
Lingerie Seams .....	3	Scarf Edge Rolled Hem .....	9
Lace Joining .....	3	Spaghetti Straps .....	9
Multipurpose Guide Foot .....	4	Fabric Flowers .....	10
Durable Three-Thread Blind Hem ....	4	Stitch Variations – Heirloom .....	10
Decorative Serging .....	4	Pin Tucking .....	11
Decorative Thread Serging .....	5	Heirloom Lace Insertion .....	11
Basic Three-Thread Flatlock.....	5	Gathering Foot Quick Start Guide ....	12
Flatlock Topstitching .....	6		

brother



## Balanced Serger Stitches

- Balanced stitches are used in construction applications such as seams, overcasting, edgings and finishes.
- A balanced three- or four-thread stitch has both looper threads meeting or knitting at the outside edge of your fabric.

See your manual for more information on balancing a stitch.

## Four-Thread Serging

Stitch	four-thread mock safety stitch
Left needle	4.0
Right needle	4.0
Upper looper	4.0
Lower looper	4.0
Thread	standard sewing
Removable stitch finger	on
Fabric	any
Stitch length	3.0 – 4.0
Foot	all purpose

- The four-thread stitch is also called the mock safety stitch.
- This stitch creates a very durable yet flexible seam.
- The four-thread stitch is created by using both needles and the loopers.
- The right (or inside) needle creates a safety stitch between the left (or outside needle) and the fabric edge.

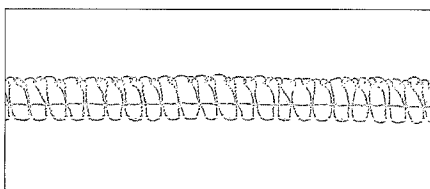

## Reinforcing Tape Application

Stitch	four-thread mock safety stitch
Left needle	4.0
Right needle	4.0
Upper looper	4.0
Lower looper	4.0
Thread	standard sewing
Removable stitch finger	on
Fabric	any
Stitch length	3.0 – 4.0
Foot	all purpose

*Shoulder seams often sag if not reinforced or stabilized.*

- To reinforce a seam, simply place a length of narrow twill tape along the seam line before sewing and serge it into the seam.
- If you want the tape to be less visible, substitute a coordinating narrow washable satin ribbon for the twill tape.
- Be sure that your needles catch the tape securely.

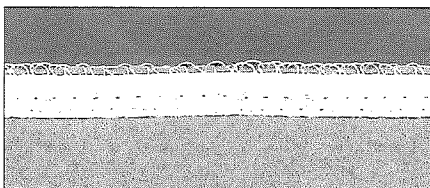

## Soft Gathering

Stitch	four-thread mock safety stitch
Left needle	5.0
Right needle	5.0
Upper looper	4.0
Lower looper	4.0
Differential	2.0
Knife	5.0
Thread	standard sewing
Removable stitch finger	on
Fabric	lightweight
Stitch length	4.0
Foot	all purpose

- Using the four-thread stitch and your differential, you can make softly gathered ruffles instantly.
- Use the set-up information and simply serge the top edge of your fabric and create your ruffle.

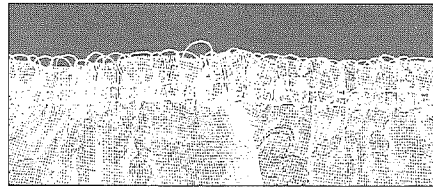

## Three-Thread Serging

Stitch	three-thread stitch, wide or narrow
Left needle	4.0 (wide) or
Right needle	4.0 (narrow)
Upper looper	4.0
Lower looper	4.0
Differential	0 – 2.0
Knife	4.0 – 5.0
Thread	standard sewing
Removable stitch finger	on
Fabric (wide)	medium to heavyweight knits
Fabric (narrow)	light to medium weight knits
Stitch length	3.0 – 4.0
Foot	all purpose

- Balanced three-thread seams have more stretch than a four-thread stitch and are generally used in construction of knit garments.
- Three-thread stitches are created by using only 1 of the 2 needles.
- Use the left needle for a wider stitch.

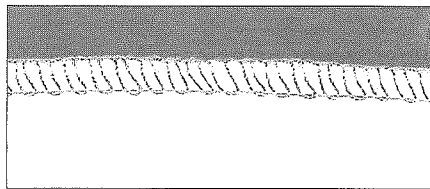

- Use the right needle for a narrow stitch.

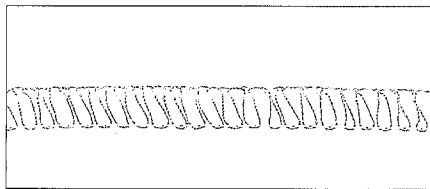

- Decorative stitches are generally three-thread stitches.

## Edge Hemming and Finishing

- Edge finishing or overcasting is a good way to keep woven fabric from raveling.
- A balanced three-thread stitch is a perfect lightweight finish.

## Lingerie Seams

Stitch	three-thread narrow stitch
Right needle	4.0
Upper looper	4.0
Lower looper	4.0
Differential	0 – 1.5
Thread	standard sewing
Removable stitch finger	on or off
Fabric	tricot
Foot	all purpose

- A balanced three-thread stitch is a perfect lightweight seam for lingerie.
- By removing the stitch finger, you can attain a very narrow and light-weight seam for lingerie.
- Experiment with the upper and lower looper tensions to create the perfect seam and finish for your lingerie project.

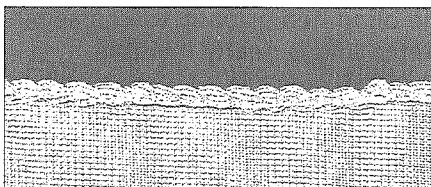
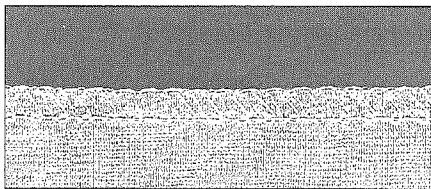

## Lace Joining

Stitch	three-thread narrow stitch
Right needle	4.0
Upper looper	4.0
Lower looper	4.0
Differential	0 – 1.5
Thread	standard sewing
Removable stitch finger	off
Fabric	lace
Stitch length	2.5 – 3.5
Foot	all purpose

- The serger is a good way to join laces and finish the edge at the same time.
- Use the set up at left and you are ready to join laces beautifully and professionally.

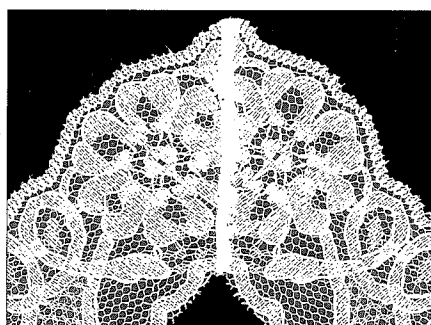
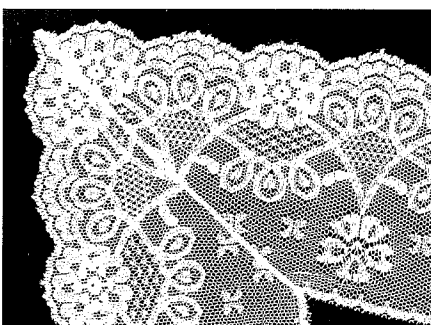
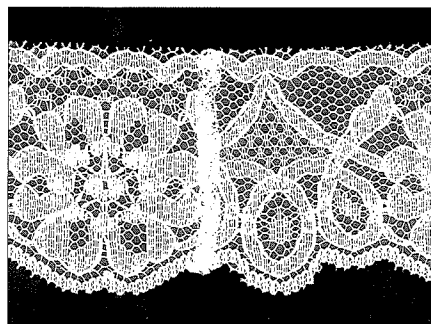
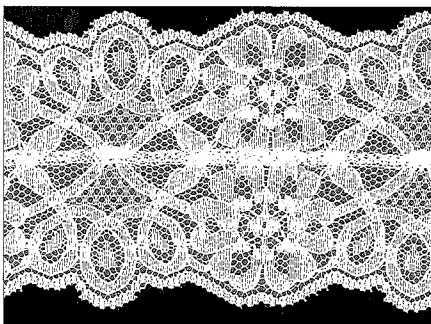

## Multipurpose Guide Foot

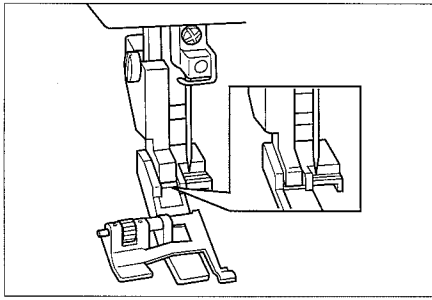

- The blind hem foot is also called the multipurpose guide foot.
- The guide is movable from left to right and can be used with the left or right needle.
- We use this foot in many decorative stitch applications to guide our fabric.

## Durable Three-Thread Blind Hem

Stitch	three-thread wide stitch
Left needle	2.0
Upper looper	5.0
Lower looper	3.0
Differential	0 – 1.5
Knife	5.0
Thread	standard sewing
Removable stitch finger	on
Fabric	woven/knit
Stitch length	4.0
Foot	blind hem

- The blind hem is basic to knit sewing. This hem is lightweight, offers stretch and is nearly invisible.
- Use your blind hem foot. You will need to practice on a scrap of your fabric to get the guide adjusted correctly.
- This adjustment will change according to the weight or thickness of your fabric.

*For more information, please see your machine manual.*

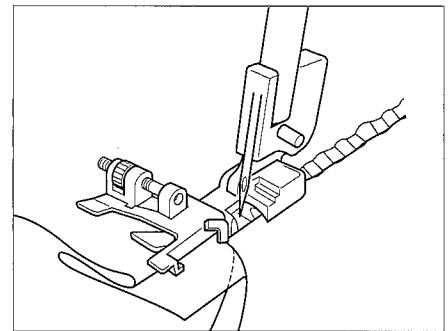
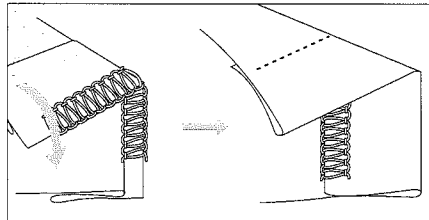
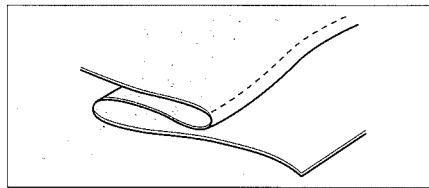

## Decorative Serging

- By unbalancing your tensions, you can create some very interesting effects. We call this decorative serging or serger embellishing.
- Adding decorative threads to your serging creates many beautiful opportunities for creative serging.

**Hint:** Once a serger stitch is formed, it is a circle of thread. When we tighten one thread, it pulls on another thread. When we lighten tension on one thread, it allows itself and another to relax or move within the circle. Thinking of the stitches in this way will help you to create the look that you want with your choice of threads.

**Learning:** Set your serger for a balanced wide three-thread stitch as shown earlier in this book. Loosen your needle tension to #2. Serge on a scrap for about 2 inches. Begin to serge again but try applying a light pinch pressure to one looper thread (just above the tension) and then the other. Observe the changes that occurred on the serged scrap. Next, set the tensions back to a balanced stitch. Loosen one of the looper tensions and pinch the threads in turn again while serging. Observe the changes to the stitch formation.

## Decorative Thread Serging

- Decorative threads can be used in both the needles and the loopers.
- Decorative threads vary in weight, fiber, shape and thickness.
- The thicker the thread, the lighter the tension needed.
- Thickness of thread is usually indicated on the spool. The lower the number, the thicker the thread.
- Heavier decorative threads are used in the loopers only.
- Most machine embroidery threads are #40 to #50 weight and can be used in your serger needles or loopers.

## Basic Three-Thread Flatlock

Stitch	flatlock
Left needle	1.0 (wide) or
Right needle	1.0 (narrow)
Upper looper	4.5
Lower looper	7.0 – 8.0
Differential	0
Knife	3.0 – 4.0
Thread	standard sewing
Removable stitch finger	on
Fabric	any
Stitch length	3.0 – 4.0
Foot	all purpose

- Flatlock is a technique in which we *unbalance* the stitch to create the stitch that we want.
- Flatlock can be used to join two fabrics or serged on a fold.
- We can use the stitch loop side or the ladder side as the top side.
- When stitching on a fold, or anytime you don't want to cut the edge, use the guide foot to guide your fabric and protect the edge.

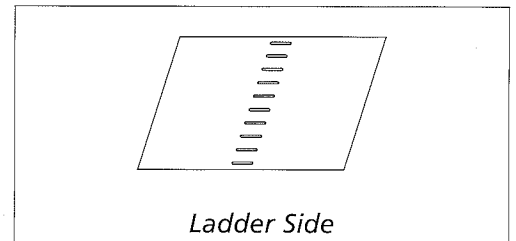
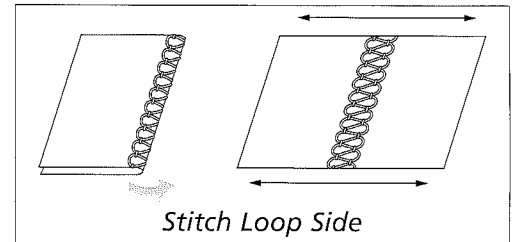
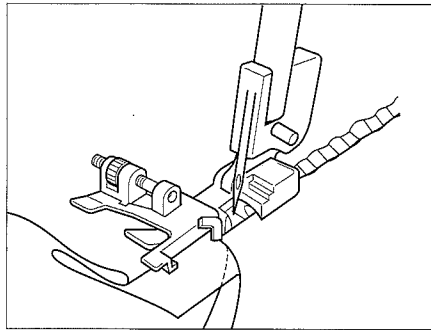

- To achieve a flatlock, our needle thread tension is loosened and our lower looper thread is tightened
- The lower looper will pull the needle thread across the back of the fabric.
- Note the reverse side of the stitch, the needle thread forms V's.
- The lower looper should be almost a straight line at the fabric edge.

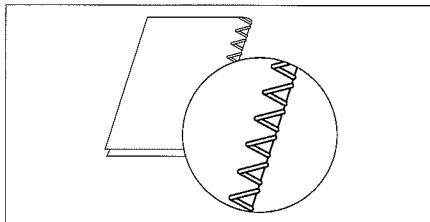

## Flatlock Topstitching

Stitch	flatlock
Left needle	1.5 – 2.0
Upper looper	2.0 – 3.0
Lower looper	7.0 – 8.0
Differential	0 – 0.7
Knife	disabled
Thread	decorative heavy
Removable stitch finger	on
Fabric	any
Stitch length	2.0 – 5.0
Foot	blind hem

- Set your machine using the settings below. Test your stitch on a scrap of fabric and adjust tensions if needed.
- Serger topstitching can be done in the body of the fabric by serging on a fold and opening it.
- Serger topstitching can be used to seam two fabrics together. Remember to lay the wrong sides of the fabric together before serging.

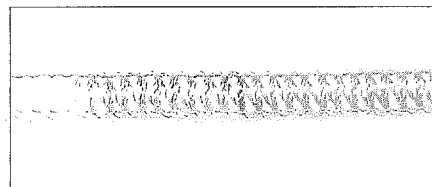
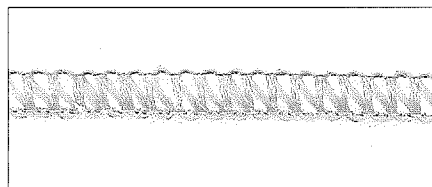

## Flatlock Appliqué

Stitch	flatlock
Left needle	2.0
Upper looper	2.5
Lower looper	6.0 – 8.0
Differential	0 – 0.7
Knife	5.0
Thread	decorative heavy
Removable stitch finger	on
Fabric	any
Stitch length	R – 3.5
Foot	blind hem

Flatlock can give a great eye-catching finish to a plain edge ribbon, lace or fabric strip while attaching at the same time.

1. Attach the multipurpose foot guide and test a scrap of folded fabric. Adjust the guide until the serger loops hang over the edge of the fold slightly.
2. Simply mark your fabric where you want the appliqué. The easiest way to do this is to press the two folds where you want the appliqué to fit.
3. Lay your appliqué piece on the fabric, matching the edge with the fold, and place under the presser foot against the guide.
4. Serge the appliqué and fabric to the end. Cut chain and open the fabric so the fabric lays flat.
5. Turn your fabric and fold the second marking fold. Make sure that the appliqué piece lays flat on the fabric and meets the fold.
6. Place the fabric appliqué on top under the foot and against the guide.
7. Serge this side of the appliqué and fabric to the end. Cut chain and open the fabric so the flatlock lays straight.

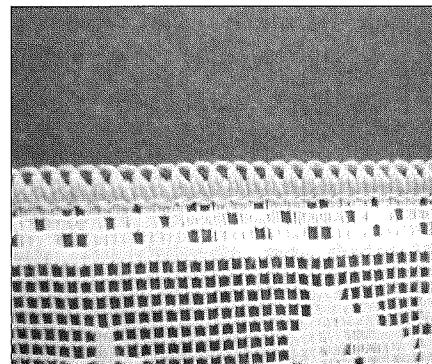
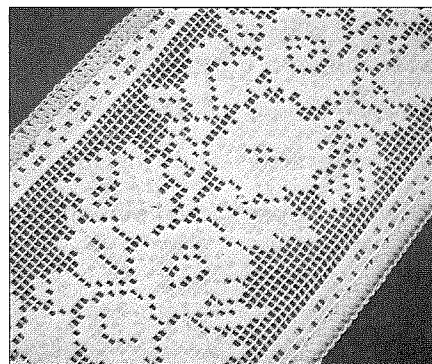



## Decorative Lace and Tape Application

Stitch	flatlock
Left needle	2.0
Upper looper	2.5
Lower looper	6.0 – 8.0
Differential	0 – 0.7
Knife	3.0 – 5.0
Thread	decorative heavy
Removable stitch finger	on
Fabric	any
Stitch length	R – 3.5
Foot	blind hem

These are quick and easy ways to apply ribbon or lace to garments or craft projects. Flatlocking lace to the body or the edge of your fabric adds a beautiful look.

1. Attach the multipurpose foot guide, set up your machine using the instructions at left and test a scrap of folded fabric. Adjust the guide until the serger loops hang slightly over the edge of the fold.
2. Simply mark your fabric where you want the lace to be sewn. The easiest way to do this is to press a fold where you will place the lace.
3. Lay your lace on the fabric matching the edge with the fold and place under the presser foot against the guide.
4. Serge the lace and fabric to the end. Cut chain and open the fold so the fabric lays flat.

Flatlocking ribbon is similar to flatlocking lace. Choose a ribbon that will fit between the needle and the edge of the fabric. Take care not to let the needle pierce the ribbon while sewing.

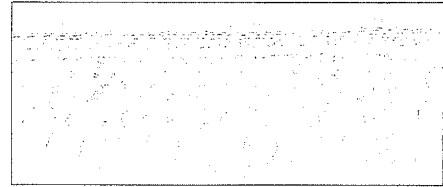
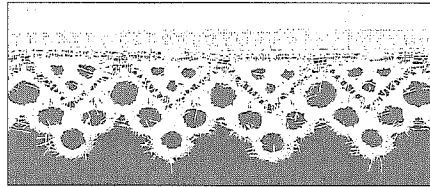

## Rolled Edge

Stitch	rolled edge
Right needle	4.0
Upper looper	4.0
Lower looper	7.5
Differential	0.7
Knife	6.0
Thread	standard
Removable stitch finger	off
Fabric	soft, very lightweight woven
Stitch length	2.0 – 3.0
Foot	all purpose

The rolled edge and its variations are probably the most used and versatile of all decorative stitches. Variations of the rolled edge make the perfect hems or edgings for napkins, curtains, ruffles, scarves, tablecloths, and so much more! At left are the set up instructions for the basic rolled edge.

*General rules: Tension and stitch-length settings will vary with the threads you use. Knife settings will vary with the fabric you use.*

## Napkin Finish Rolled Edge (narrow)

---

Stitch	narrow rolled edge
Right needle	4.0
Upper looper	5.0
Lower looper	7.0
Differential	0.07 – 0
Knife	3.0 – 5.0
Thread	standard sewing
Removable stitch finger	off
Fabric	lightweight woven
Stitch length	R
Foot	all purpose

- Using the set up instructions at left, set your serger for rolled edge. Check your manual for information about removing the stitch finger.
- The set up instructions reflect tensions using standard sewing thread. You may have to adjust any tension setting for changes in thread type.
- Always allow your knife to *shave* the edge of your fabric creating an even and consistent fabric edge.

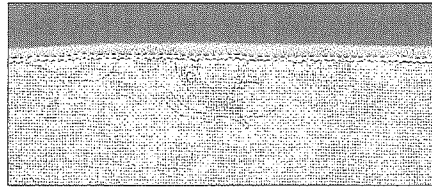

*NOTE: Fabric that has an uneven texture may not be successfully edged with a narrow rolled hem.*

## Tablecloth Edging (wide)

---

Stitch	rolled edge wide
Left needle	4.0
Upper looper	5.0
Lower looper	7.0
Differential	0.07 – 0
Knife	5.0 – 6.0
Thread	standard sewing
Removable stitch finger	off
Fabric	light to heavyweight woven
Stitch length	R – 3
Foot	all purpose

- Some fabrics are too heavy or too loosely woven to roll successfully using the narrow rolled hem.
- Try the set up at left and create a wide rolled hem.
- If the fabric doesn't roll, lengthen the stitch. The longer the stitch, the more able it is to roll a heavier fabric.
- This hem also gives a little more body to medium weight fabric.

## Formal and Bridal Wear



Beautiful effects can be created for formal wear using your serger and a few simple techniques.

### Scarf Edge Rolled Hem

Stitch	narrow rolled edge
Right needle	4.0
Upper looper	4.0
Lower looper	7.5
Differential	0.7
Knife	6.0
Thread	#40
Removable stitch finger	off
Fabric	soft, very lightweight woven
Stitch length	2.0 – 3.0
Foot	all purpose

- Chiffon and satin, as well as other delicate fabrics, require a delicate hem.
- The scarf edge rolled hem is perfect for these applications.

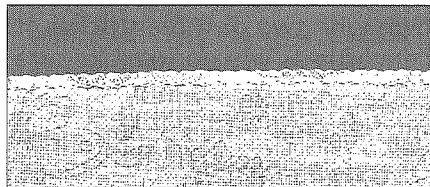

### Spaghetti Straps

Stitch	very narrow balanced
Right needle	4.0
Upper looper	4.0
Lower looper	4.0
Differential	0
Knife	2.0 – 3.0
Thread	standard sewing
Removable stitch finger	off
Fabric	lightweight
Stitch length	2.0 – 3.0
Foot	all purpose

Spaghetti straps are a must for formal and bridal wear, lingerie, and many other applications.

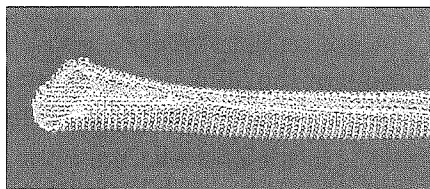

1. Cut 1/4" strip of bias or knit fabric and fold in half lengthwise.
2. Place folded strip under the presser foot (fold to the left) and serge the two raw edges together making sure to leave at least 3" of serger chain.
3. Thread the serger chain through a tapestry or yarn needle eye and knot it to hold to chain securely. (No appropriate needle? A bobby pin will do!)
4. Feed the needle and chain through the inside of the tube and turn the strap right side out as you go.

## Fabric Flowers

Stitch	narrow rolled edge
Right needle	4.0
Upper looper	4.0
Lower looper	7.5
Differential	0.7
Knife	6.0
Thread	#40
Removable stitch finger	off
Fabric	soft, very lightweight woven
Stitch length	2.0 – 3.0
Foot	all purpose

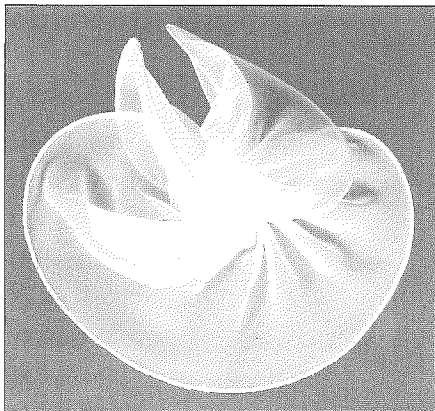

Have you ever noticed those beautiful flowers or chiffon ruffles on many formal dresses? Your rolled edge and some 20# or 50# fishing line is all you need!

One key to beautiful ruffles and flowers is to use fabric cut on the bias.

1. Set your serger for a narrow rolled edge.
2. Cut a 3" bias strip of fabric (a bias cut on a 45" fabric is about 56–58" long).
3. Place the spool of fishing line at the front or right side of your machine where it will be convenient for you.
4. Feed the end of the fishing line through the small hole in the front of the toe of the standard foot of your serger. Then bring it back toward the rear of the foot, making sure that the line is very close to the fabric bed. Allow about 12" of extra line to remain on this end of the line behind the serger. Turn your serger's handwheel and secure the line down with two or three stitches. Note that you will have to guide the line a little as you go to make sure the knife doesn't cut it while you are sewing.
5. Place one long edge of bias strip under the presser foot and begin to serge feeding the fishing line as you go. The rolled edge stitch will encase the fishing line and your edge.
6. When you come to the end of your fabric, measure an additional 12" of line from the toe and cut the line. Unthread the 12" from the hole on the foot, raise the presser foot, and bring the line under the foot and off to the left side out of the way of the needle and the knife. Serge off and clip your serger chain.
7. Gently smooth the fabric over the line allowing the extra line to be pulled up into the flower's edge.
8. Return your serger to a balanced four-thread stitch, and follow the soft gather instructions to finish the opposite edge. Finish by further gathering the edge and forming your flower using a hand needle and thread.

## Stitch Variations – Heirloom

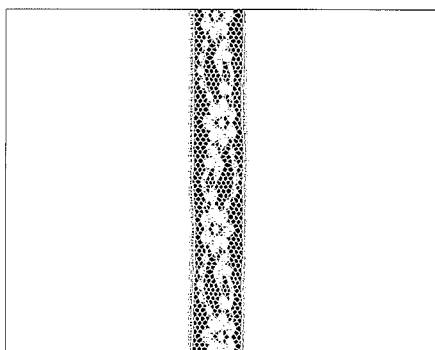

Using some of the Stitches that you have learned, now you can create beautiful heirloom stitches quickly and easily, with a few setup changes.

The stitches in the photo to the right are simply rolled edge and flatlock variations are a very good example of vertical pin tucking.

## Pin Tucking

Stitch	rolled edge
Right needle	4.0
Upper looper	4.0
Lower looper	7.5
Differential	0.7
Knife	disabled
Thread	#40
Removable stitch finger	off
Fabric	soft, very lightweight woven
Stitch length	1.0 – 2.5
Foot	blind hem

- Serger pin tucks are simply a rolled edge setup stitched on the fold of a fabric.
- Pin tucks do not roll.
- Using the multipurpose guide foot keeps the folded edge of the fabric close to the needle and allows extremely straight, narrow and delicate stitches.
- Vertical pin-tucking should be serged in one direction on half of your panel and the fabric turned and then serged the other direction on the other half.

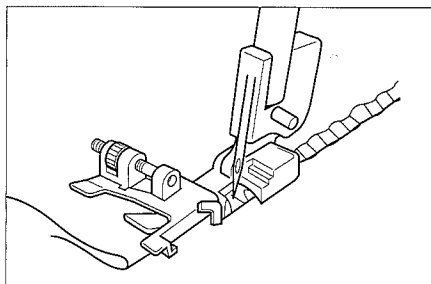

*Your guide foot will help you make perfect pin tucks.*

1. Mark your lines for stitching by pressing in folds to be serged.
2. If you are creating a panel with vertical pin tucks, determine the center of your panel and work outward one side at a time.
3. Serge down each of your pin tuck lines.

## Heirloom Lace Insertion

Stitch	flatlock
Right needle	1.0 – 2.0
Upper looper	4.0
Lower looper	7.0 – 8.0
Differential	0 – 0.7
Knife	disabled
Thread	lightweight decorative or standard sewing
Removable stitch finger	off
Fabric	lightweight
Stitch length	2.0 – 4.0
Foot	blind hem

- Serger lace insertion is simply a narrow flatlock setup.
  - Using the multipurpose guide foot keeps the edge of the fabric and lace close to the needle and allows extremely straight, narrow and delicate stitches.
  - Flatlock should be serged in one direction on the first side of the insertion and serged the other direction on the other side.
  - The loop or the ladder side may appear on the surface of the insertion. The loop side will appear to be a trim, the ladder side appears as delicate hand stitches joining the fabric to the lace.
1. Fold the fabric edges you will be flatlocking the lace to back  $\frac{1}{4}$ " and press. (We will refer to the wrong side of the fabric as the side that the raw edge was folded to.)
  2. Lay your insertion lace on the folded edge of your fabric. If your fabric is laying wrong side up, the loops will appear on the right side of the fabric. Likewise, if your fabric is laying right side up, the ladder side will appear on the right side of the fabric.
  3. Serge from top to bottom. Open the flatlocked fabric and lace so they lie flat.
  4. Lay your next piece of fabric with the SAME SIDE UP that you used in the second step on a flat surface. Lay your serged piece on top. Make sure the lace meets the fold and your pieces of fabric are arranged so that the same sides face each other. Serge the lace and fold together.
  5. Open this side of the fabric and see how lovely and delicate this technique is.

*NOTE: Insertion lace is flat (not gathered) and has straight edges on both edges. Practice this technique and test your stitch length and threads using inexpensive prepackaged hem lace that can be found in the tapes display wherever you buy fabric and notions.*

## Gathering Foot Quick Start Guide

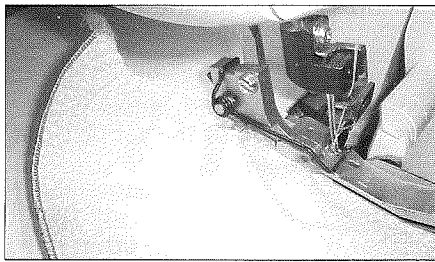

Your serger gathering foot is designed to be used to gather fabric that is placed under the foot or to gather one fabric into another (shirring) by placing a second fabric through the slot and above the separator plate.

The gathering foot accelerates the gather produced by the differential feed dog creating beautiful ruffles and gathers in light to midweight fabrics.

### Getting Ready

Always test a strip of your fabric first to determine the rate at which it will gather.

#### Settings:

For optimum gathering, use 4 threads (both needles), set your differential to 2, your stitch length to 4 and your presser foot pressure to light to moderate pressure.

The numbers on the differential dial represent the rate at which the differential (front) feed dog is feeding into the take up (rear) feed dog. The number 2 represents that the differential is feeding at a ratio of 2 to 1. If you wish to use the serger to less fully gather fabric, simply adjust the differential down and test a strip of the fabric you will be using.

- The differential will gather different fabrics at different rates according to the fabric's weight and finish. Always test strips of your fabric before gathering.
- Gathers may be adjusted within the length of the gathered strip.
- You may create lovely single layer ruffles by first serging a rolled edge to your fabric to be ruffled and gathering the opposite edge.

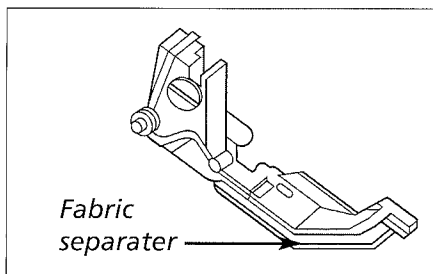

### Adapting your pattern or plan for serger gathering

Because the serger is a different way to gather, you may have to plan your sewing a little differently. Creating an exact fitting gather is difficult. Therefore, we suggest that you take the time to look at your project and fabric to see what changes you may need to make before you start.

First, test a strip of your fabric by measuring the length of the strip before and after gathering. Compare the two and you will know the best ratio that you can achieve with that fabric.

*Hint: Gather fabric or ruffle to a base fabric and finish seams last.*

### Shirring a skirt into a bodice or waistline.

Choose a pattern with straight seam lines on the sides that will be joined with the serger such as side seams, lower bodice seam, hem and waistline.

Then measure your skirt fabric pattern at the waist and compare it to the measurement of the bodice you will be gathering the fabric to. Compare this to the ratio of your test strip. This will help you to determine if your fabric is suitable and will give you enough fullness to successfully serger gather the pattern and fabric that you are planning to use.

You may gather your skirt directly onto the bodice (shirring) or gather the waistline first and fit it to the bodice and sew or serge the two together in a second step.

If you decide to gather and seam in one step, cut your fabric according to the pattern at the top and bottom but adding several inches in width. This extra fabric will allow you some flexibility when serger gathering. Serge the skirt to the bodice and trim excess from the sides making sure that you are cutting equal amounts from top to bottom.



## Gathering Foot Quick Start Guide (continued)

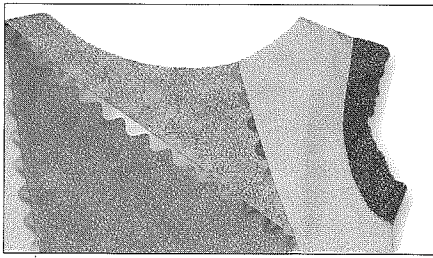

Finish serging the rest of the garment.

To maximize fullness, strips were cut and shirred together one at a time.

Adding a ruffle at the armhole replaces the need for facings on a sleeveless garment.

(Jumbo Rick Rack was sandwiched in between fabrics before seaming to create decoration on bodice.)

### Shirring Curtain Ruffles

Curtain ruffles should be made in a similar fashion as above skirt application. Edge the strip to be ruffled, then shirr the ruffle to curtains, trim excess ruffle length and finish.

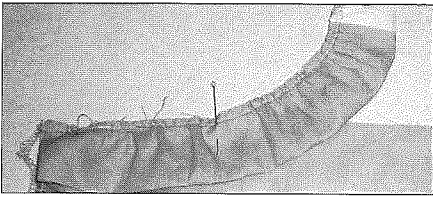

### Pillows or other Closed Ruffle Projects

Sometimes as with a pillow, edges of a ruffle will be joined (closed) before construction.

#### Traditional Ruffle:

Test your fabric, determine the ratio and cut your fabric strip to the appropriate length to go around the project.

Join the ends of your strip to be ruffled. Serger gather the strip making sure to leave 2–3" of serger chain at the beginning and at the end of gathering. Mark your ruffle in 1/4ths. Mark your project in 1/4ths. Match the markings and ease the ruffle into each 1/4th. Sew or serge the ruffle to the project.

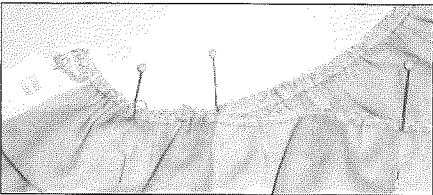

#### Fast Ruffle Applications:

Consider gathering the ruffle strip first and then fitting it to the pillow. See step by step instructions at left. Cut your strip to be gathered 6" to 8" longer than you will need to go around the pillow. Create your ruffle by gathering it on the serger.

Secure one end of the ruffle in the seam line of your project, leaving 3–4" free. Fit the remainder of the ruffle to the edge of your project securing as needed. When you get to the first end of your strip, overlap the two ends at least 1–2" bending the ends into the cutting line so that the ends are not joined, but rather are decoratively overlapped. Sew or serge the ruffle in place.

For the pillow finish illustrated below, 8 strips were cut, each strip was first edged with a rolled hem and then trimmed to a curve at each end.

Gathering the strips down the entire raw edge creates lovely ruffles.

The ruffles can then be placed on the pillow front and serged.

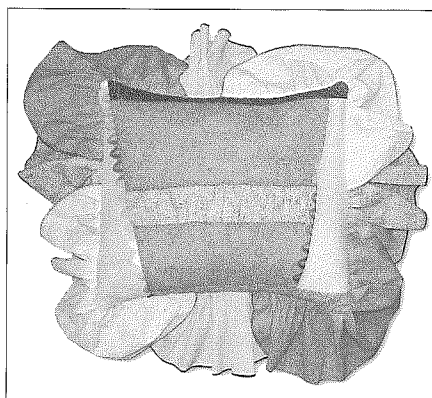
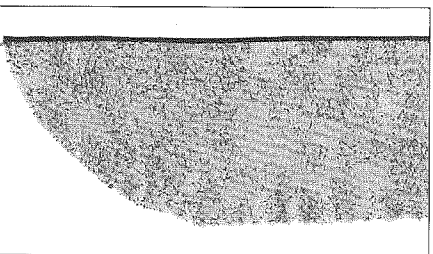
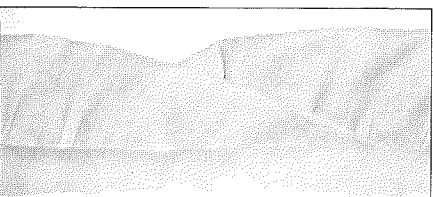
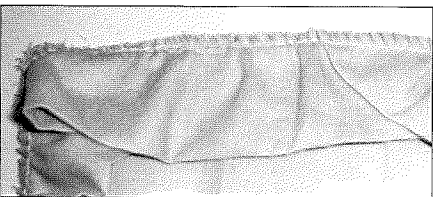

*This pillow was designed to be serger finished and demonstrates a beautiful way to adapt to using the serger to gather ruffles easily.*

**brother**®