

Assembly Instructions

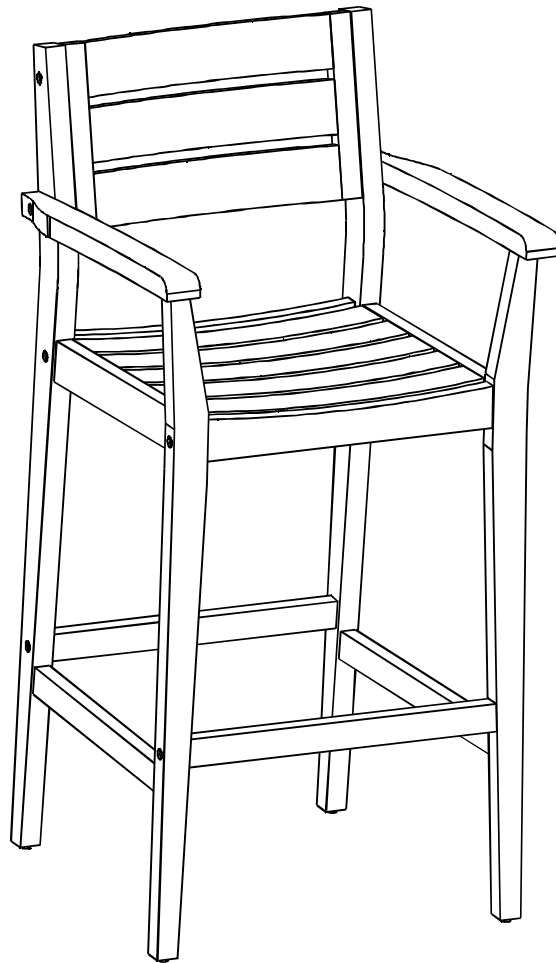



Caution: You must read this before you proceed

Bar Chair



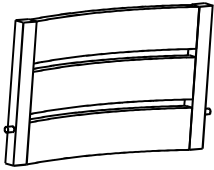
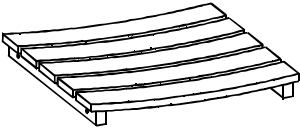

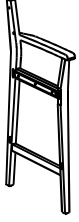

Caution: This Bar Chair is NOT a TOY.
Keep your child / children at bay during the assembly process.
For moving the Bar Chair and to prevent damage to the Bar Chair, two adults are needed to execute this action.

Parts List

Label	Picture	Description	QTY
A		Backrest Panel	1
B		Seat Panel	1
C		Seat Support Bar	2
D		Back Footrest	1
E		Front Bar	1
F		Left Leg Panel	1
G		Right Leg Panel	1





Hardware

Label	Picture	Description	QTY
①		Screw (M7x80mm)	5
②		Screw (M7x60mm)	7
③		Screw (M6x35mm)	5
④		Allen Key	1

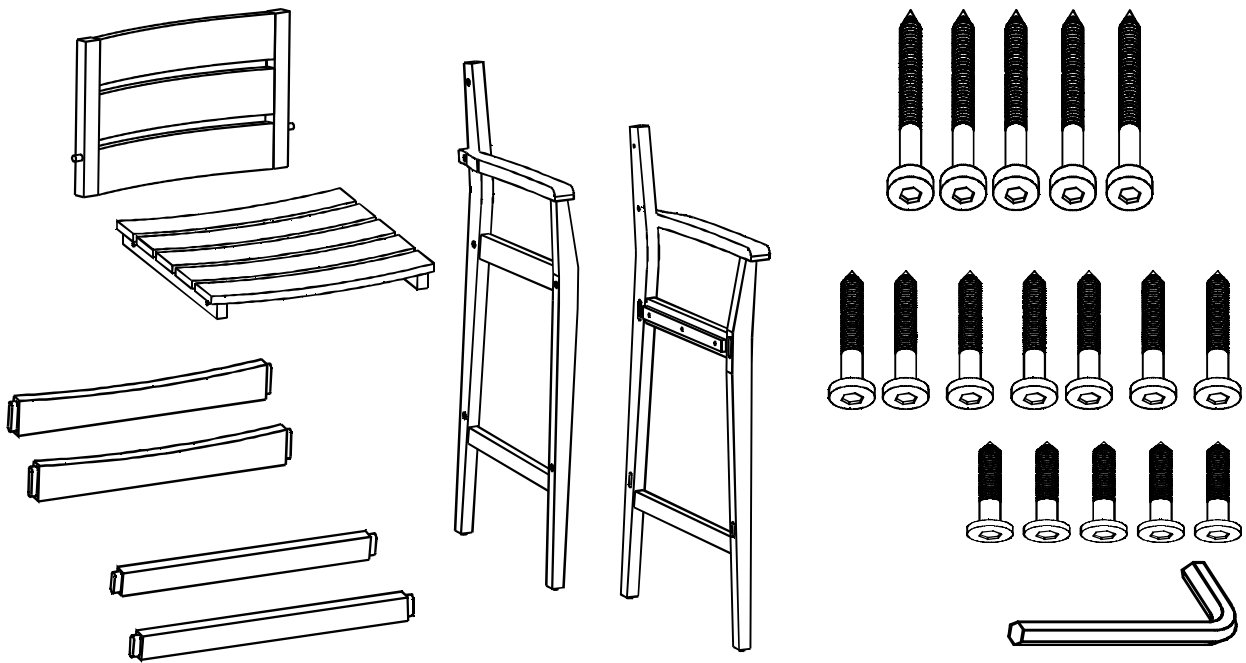
Assembly Preparation

Before Beginning Assembly:



-  • Read instructions, cover to cover-
-  • Have 2 adults on hand for assembly-
-  • Do not assemble on flooring or carpet-
-  • Assemble on a clean non-marring surface (packing foam)-
-  • Save all packaging until finished-

Before Beginning Assembly:

OVERVIEW

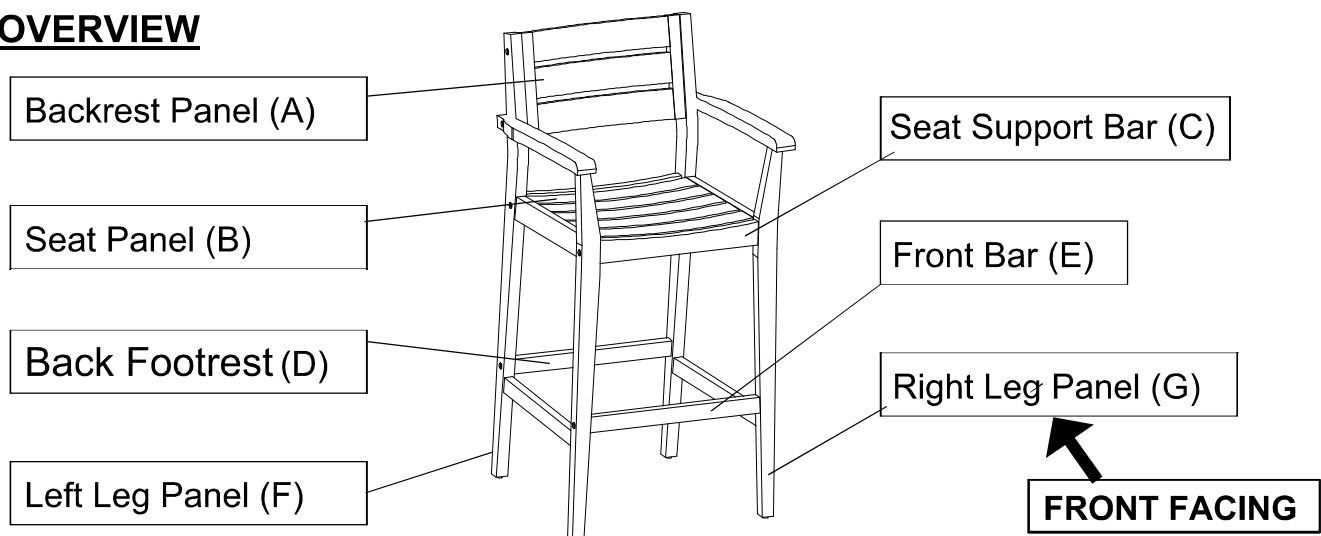

This Bar Chair has multiple parts and may require up to 30 minutes to assemble. To give you an overview of the Bar Chair parts, the above picture is to help you put the various parts into perspective. Please read through the instructions below to familiarise yourself with the parts and steps before assembly.

Step 1

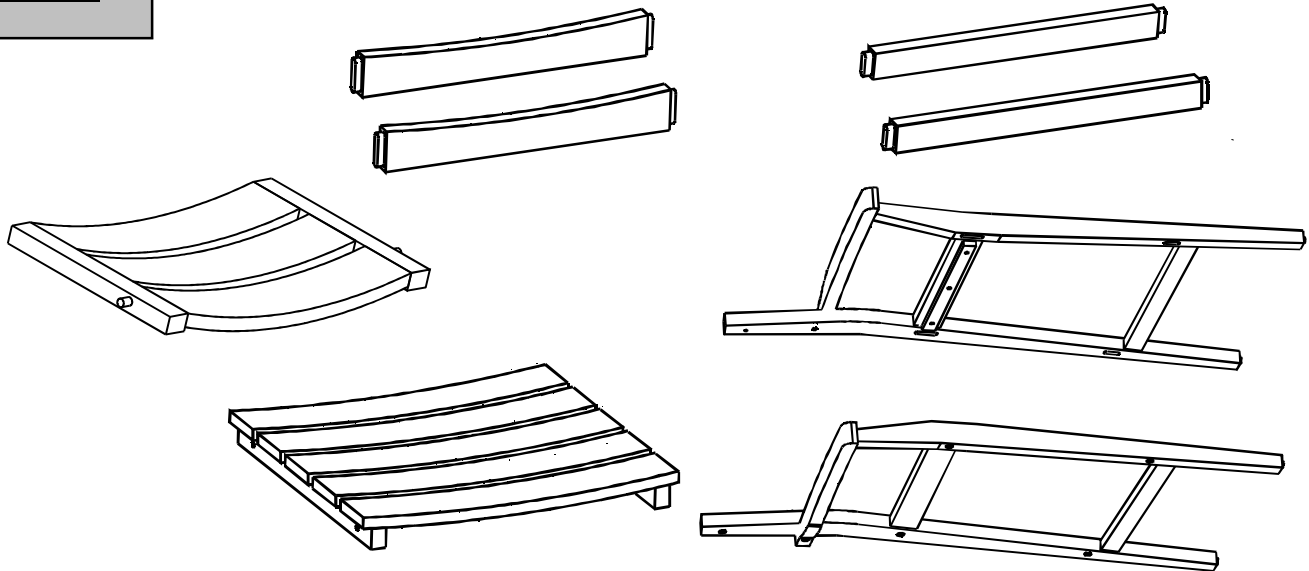

Unpack and place all parts on a clean, non-marring surface.

Step 2

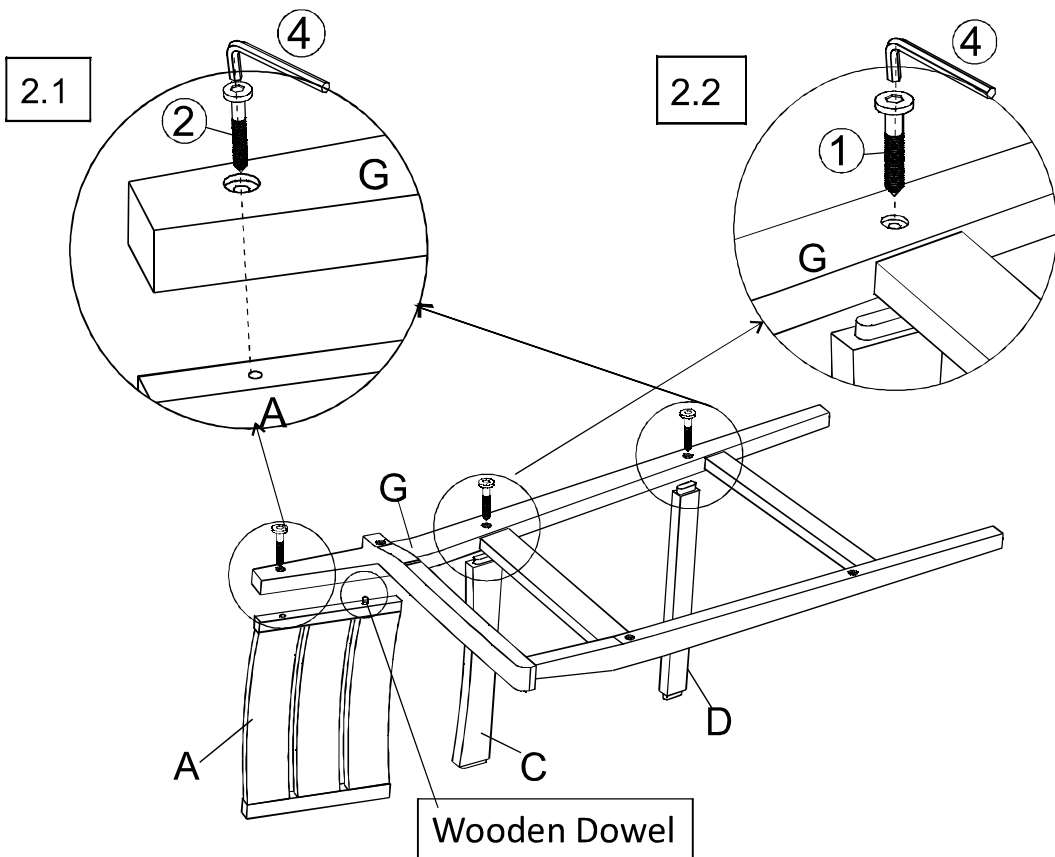

2.1) Insert Wooden Dowel on Backrest Panel(A) into Right Leg Panel(G) then attach using Screw(2) with Allen Key(4) as above picture.

2.2) Insert the tenons on Seat Support Bar(C) and Back Footrest(D) into the mortises of Right Leg Panel(G) as shown above.

Attach Right Leg Panel(G) to Seat Support Bar(C) and Back Footrest(D) using Screws(1) with Allen Key(4) as shown in picture above.

Do not fully tighten the Screws.

Step 3

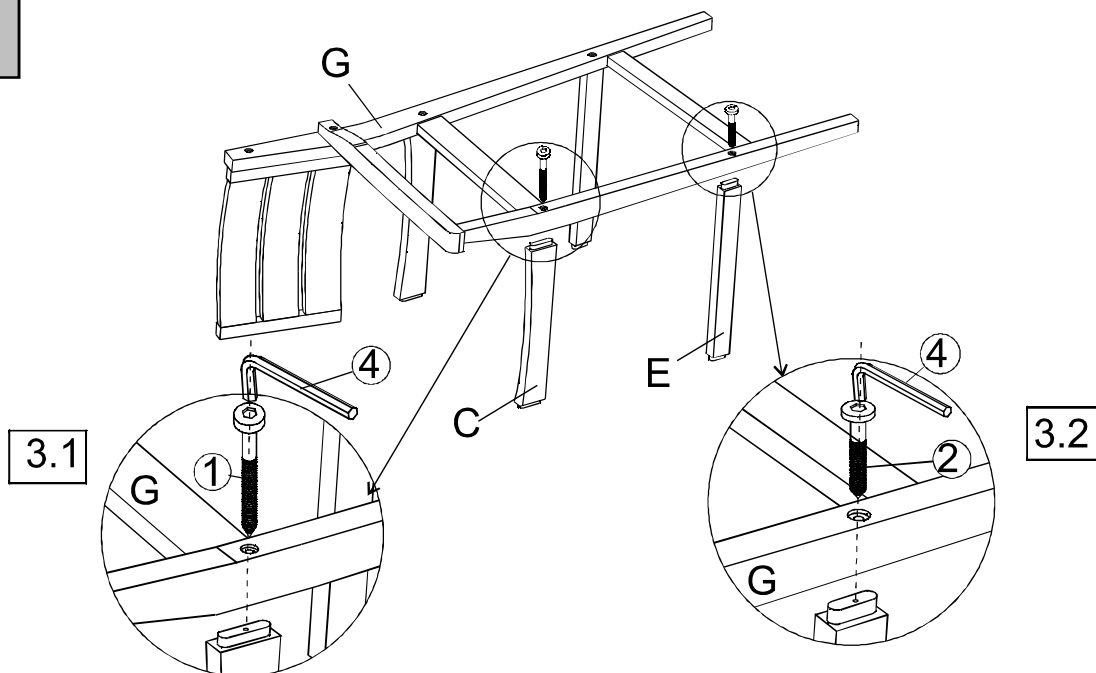

3.1) Attach Seat Support Bar(C) to Right Leg Panel(G) using Screw(①) with Allen Key(④).

3.2) Attach Front Footrest(E) to Right Leg Panel(G) using Screw(②) with Allen Key(④).

Do not fully tighten the Screws

Step 4

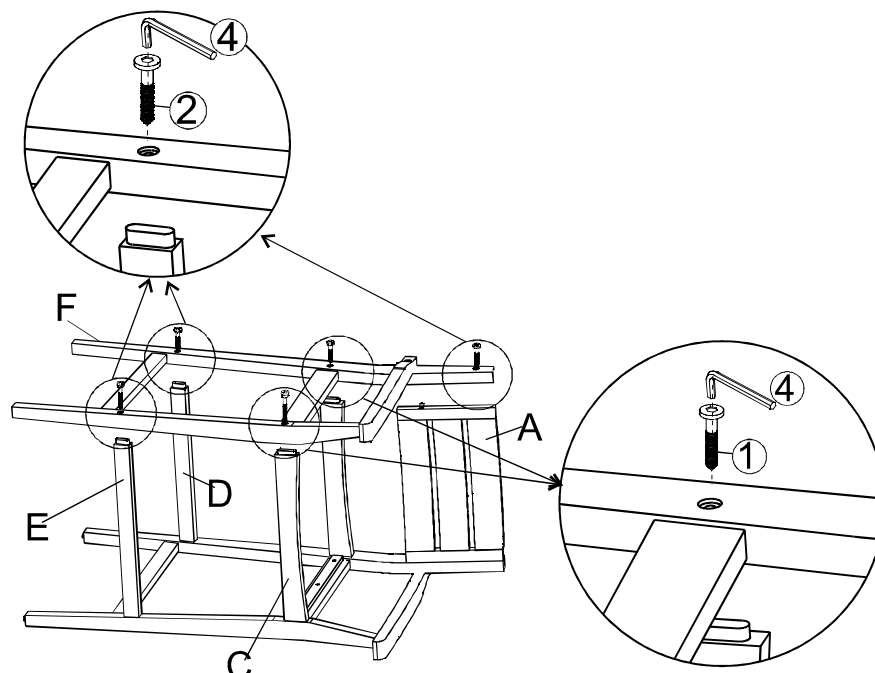

With assistance from your adult partner, turn the Bar Chair over onto another side.

Attach Left Leg Panel(F) to Backrest Panel(A), Seat Support Bars(C), Back Footrest(D), and Front Footrest(E) using Screw(①), Screw(②) and with Allen Key(④)

Do not fully tighten the Screws.

Step 5

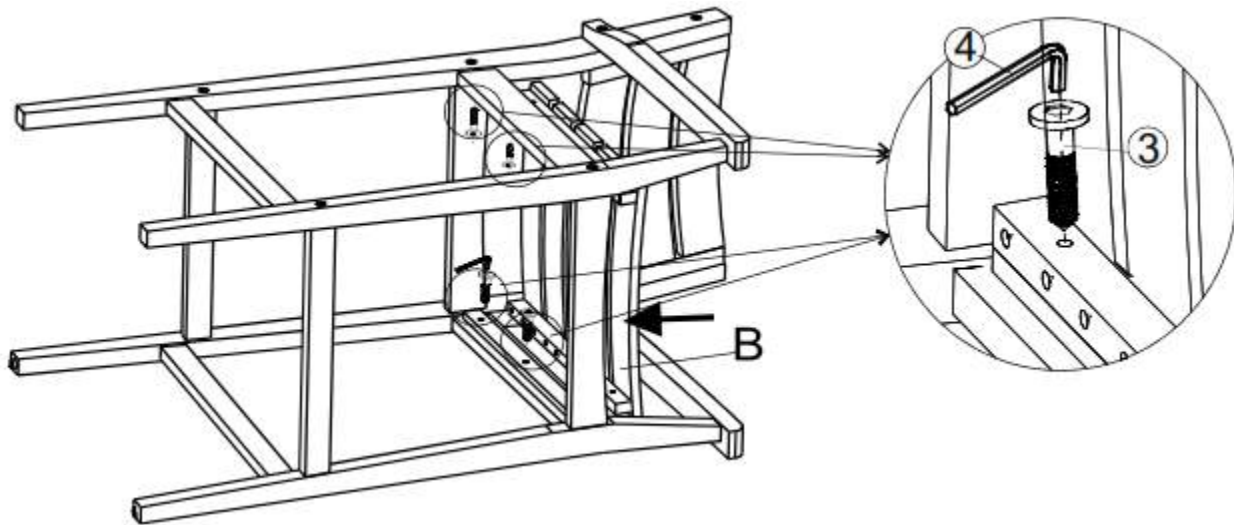





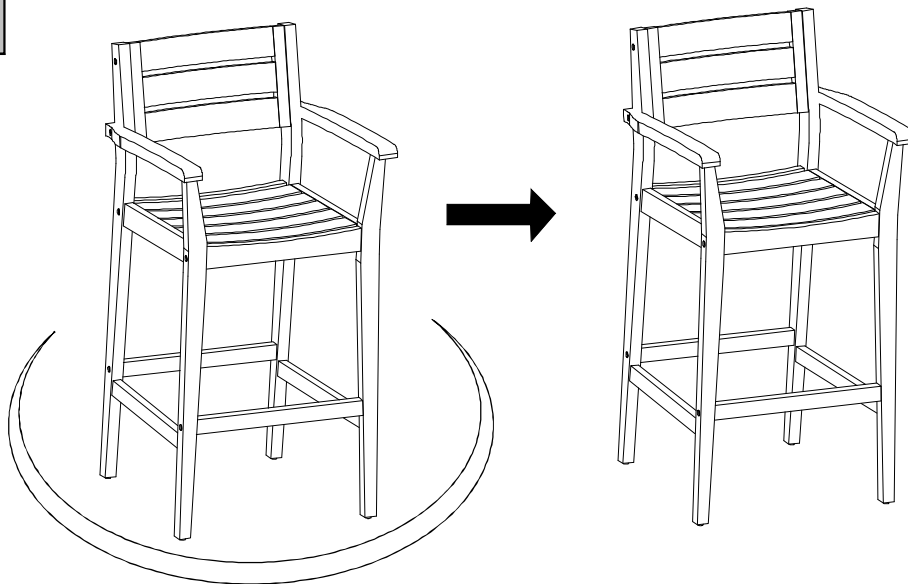



With assistance from your adult partner, put Seat Panel(B) to Bar Chair as pictured. Attach Seat Panel(B) using Screws(③) with Allen Key(④).
Do not fully tighten the Screws.

Step 6



Stand the Bar Chair up, with assistance from your adult partner.
Exert pressure floorwards, onto the Bar Chair with both your hands.
This pressure will help all Bar Chair parts and Screws reach full alignment status.
Check for wobbles on a LEVEL surface.
If no wobbles are found proceed to tighten the Screws in a sequential manner, until evenly secured.
When tightening the Screws tighten sequentially.
Do not tighten any Screw fully and then move on towards the next one.
If there are still wobbles, loosen the Screws and excute the same above process.
Your Bar Chair is ready for use.
This Bar Chair can only be used on the flat, level surface.

Care & Maintenance

-  Do not put hot items directly on furniture surface
-  Do not clean furniture with harsh cleansers or polish.
-  To obtain the longest lifespan of your outdoor products, minimizing exposure to direct sunlight is recommended.
-  Children should not climb or jump on the furniture.
-  Do not write on furniture without a padded barrier to protect the surface.
-  To obtain the longest lifespan of your outdoor products, avoid extended and lengthy exposure to rain, snow, and direct sunshine. Whenever possible cover the product and /or place under patio or awnings.
-  Not for commercial use. For residential use only .
-  Stains may be removed with mild soap solution and damp cloth.

-  Dust and pick-up spills using a clean, non-colored, lint-free cloth .