

ASSEMBLY INSTRUCTIONS

BED - FULL

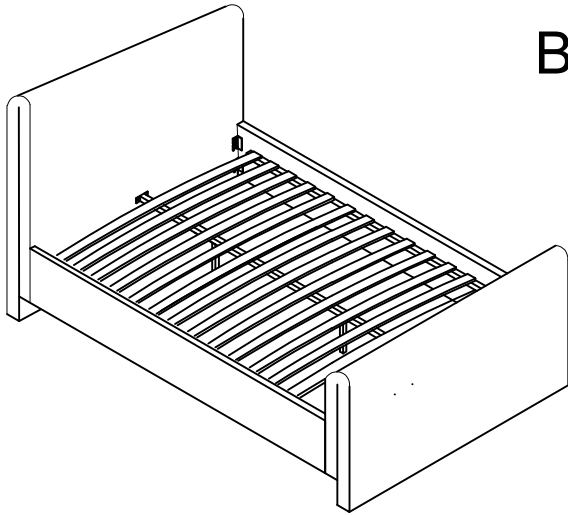

+ Do Not Use Power Tools

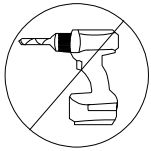

+ Suggested Adults

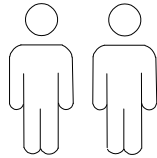

NOTE:

- 1 Read instructions cover to cover.
- 2 Save all packaging until assembly is completed.

1 IMPORTANT SAFETY INFORMATION

Do not assemble the product if any of the following parts arrived damaged:

- Part #③ -Side Rails
- Part #④ -Slats joint
- Part #⑤ -Center Support Bar
- Part #⑥ -Support Legs

2 IMPORTANT ASSEMBLY INFORMATION

Assembly Step ② Ensure the side rail bracket is fully hooked onto bolt **A** loosely threaded with both washers on the **OUTSIDE** of the bracket first, then proceed to fully tightening all 4 corners.

*Slats come packed in the bottom of headboard carton.

+ Parts Included

① Head Board (1pc)

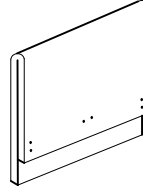

② Foot Board (1pc)

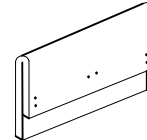

③ Side Rails (2pcs)

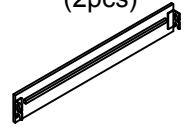

④ Slats joint (1set=12pcs)

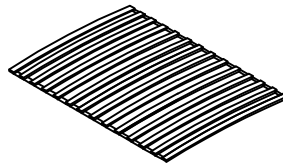

⑤ Center Support Bar (1pc)

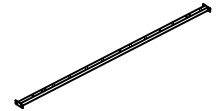

*Slats come packed in the bottom of headboard carton.

⑥ Support Legs (2pcs)



+ Hardware Included

A Bolt M8*35mm (16pcs)



B Spring Washer (8pcs)



C Flat Washer $\varnothing 20$ (16pcs)



D M8 Allen Key (1pc)



E Nut M8*13mm (4pcs)



F Spanner (1pc)



ASSEMBLY INSTRUCTIONS

BED - FULL

①

Ensure the C Flat Washers are installed on BOTH the top and bottom of the Center Support bar !

② Repeat this step for each corner of the bed.

① ② ③ ④ ⑤ ⑥

③

① ② ③ ④ ⑤ ⑥

④