







ASSEMBLY INSTRUCTIONS

Don't tighten any Bolts until all Bolts on a step have been started

Thank you for purchasing this quality product. Be sure to check all packing material carefully for small parts, which may have come loose inside the carton during shipment. Identify and count all parts and compare with the **HARDWARE LIST** below.

NO	PARTS LIST		Q'TY
A		Linen fabric seat	1
		Top ring	pre-Assy
B		Metal swivel	1
		Middle ring	pre-Assy
C		Bottom ring	1
D		Stool leg	4

NO.	PARTS LIST		Q'TY
1		1/4''*2''	8
2		1/4''*1 1/2''	4
3		1/4''*1''	4
4		1/4''	16
5		1/4''*19mm	16
6		Allen Wrench	1

STEP 1

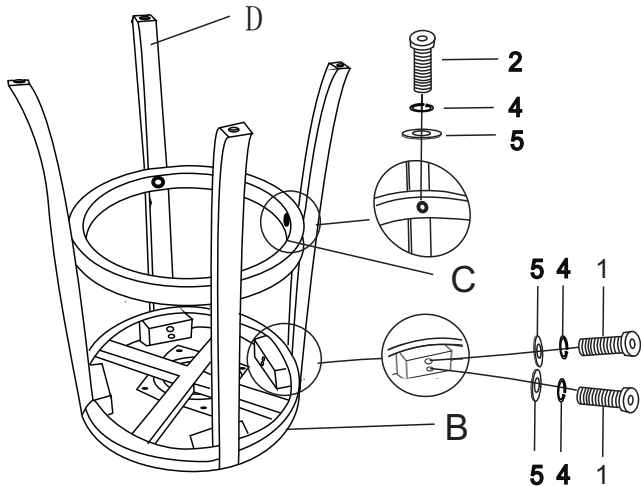

1. Attach the four Legs (D) to the Middle Ring (B), using Bolts (1+4+5) to tighten, as shown
2. Attach the Bottom Ring (C) to the Legs, using Bolts (2+4+5) to tighten, as shown.

STEP 2

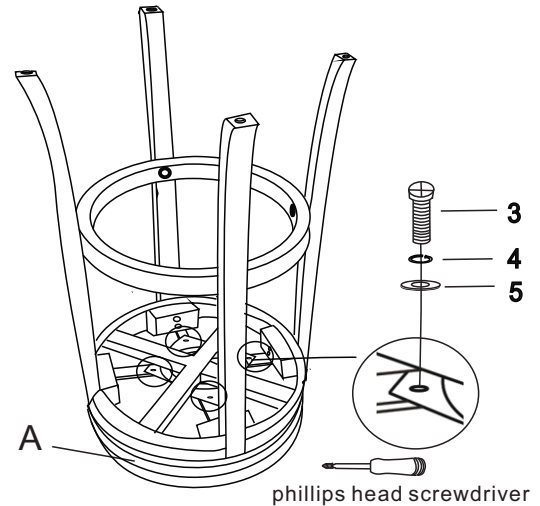

1. Upside down the Bonded leather seat (A) and put it on a smooth and stable working stand.
2. Attach the assembled Legs frame to the Seat w/top ring (A), using a Phillips screwdriver (not included) and Bolts (3+4+5) to tighten, as shown.

STEP 3

1. Right side up the stool.
2. It's complete for using.

Caution: 1: All bolts must be tightened mandatorily in each step.
2: It is also mandatorily recommended to periodically check bolts and retighten as needed."

