

# Manual de montagem Assembly manual Manual de montaje

## Mesa / Table / Mesa

### Montagem

Recomenda-se a leitura prévia das instruções de montagem e profissionais especializados para montar.

### Assistência

Caso ocorra problema com alguns dos componentes, sublinhe o componente, identifique o problema e retorne esta relação, via fax ou meio de comunicação disponível para o representante.

Assinatura do cliente

### Assembly

It is recommended before the assembling to read carefully the assembly instruction by professional assemblers.

### Assistance

It happen problems with some component, underline the same, identify the problem and send back this relation immediatily, by fax or other way.

Client signature

### Montaje

Se recomienda la lectura previa de las instrucciones de montaje y profesionales especializados para montarlos.

### Asistencia

Caso sucedan problemas con alguno de los componentes, subraye el componente, identifique el problema, y retorne esta copia via fax u otro medio de comunicación posible.

Assinatura del cliente



## Atenção / Attention / Atención

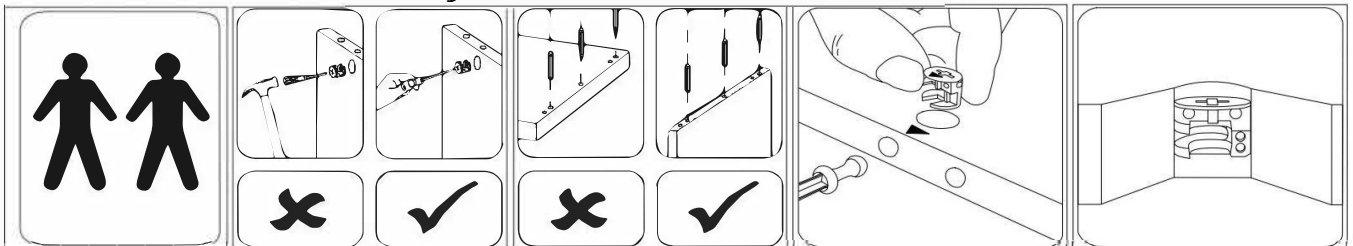

A se reserva no direito de efetuar alterações nos produtos de suas linhas, sem aviso prévio, quando entender necessário.

I reserves the right to effect modifications in the products, without previous advice, when undersdtand necessary.

se reserva el derecho de hacer las modificaciones que juzgue necesarias en sus productos, sin aviso previo, cuando lo crea necesario.

**RELAÇÃO DE COMPONENTES / PARTS LIST / LISTA DE COMPONENTES**

SEQ. EMB.	LETRA	LACA	VIDRO COLADO	LÁMINADO	PEÇA	PART	PIEZA	MED/MEASURE/MED	QTDE
<b>1200Ø</b>						<b>VOLUME 1</b>			
01	A	-	-	-	TAMPO	TOP	SOBRE	1200.0x1200.0x25.0	1
								<b>LÂMINA / LACA / VIDRO COLADO</b>	
								734.0x622.0x622.0	1
<b>1200Ø</b>						<b>VOLUME 2</b>			
01	C	-	-	-	SUPOORTE TAMPO KIT ACESSÓRIOS	TOP SUPPORT ACCESSORY KIT	SOBRE SOPORTE KIT ACESSÓRIOS	418.0x418.0x18.0	1
Ao lado	-	-	-	-	-	-	-	-	1
<b>1200Ø</b>						<b>VOLUME 3</b>			
01	B	-	-	-	BASE SAARINEN REDONDA COM PARAFUSO	BASE	BASE	734.0x622.0x622.0	1
<b>1500Ø</b>						<b>VOLUME 1</b>			
01	A1	-	-	-	TAMPO	TOP	SOBRE	1500.0x1500.0x25.0	1
								<b>LÂMINA / LACA / VIDRO COLADO</b>	
								1500.0x1500.0x25.0	1
<b>1500Ø</b>						<b>VOLUME 2</b>			
01	C	-	-	-	SUPOORTE TAMPO KIT ACESSÓRIOS	TOP SUPPORT ACCESSORY KIT	SOBRE SOPORTE KIT ACESSÓRIOS	418.0x418.0x18.0	1
Ao lado	-	-	-	-	-	-	-	-	1
<b>1500Ø</b>						<b>VOLUME 3</b>			
01	B	-	-	-	BASE SAARINEN REDONDA COM PARAFUSO	BASE	BASE	734.0x622.0x622.0	1
<b>1900x1100</b>						<b>VOLUME 1</b>			
01	A2	-	-	-	TAMPO	TOP	SOBRE	1900.0x1100.0x25.0	1
								<b>LÂMINA / LACA / VIDRO COLADO</b>	
								1900.0x1100.0x25.0	1
<b>1900x1100</b>						<b>VOLUME 2</b>			
01	C2	-	-	-	SUPOORTE TAMPO KIT ACESSÓRIOS	TOP SUPPORT ACCESSORY KIT	SOBRE SOPORTE KIT ACESSÓRIOS	1100.0x600.0x75.0	1
Ao lado	-	-	-	-	-	-	-	-	1
<b>1900x1100</b>						<b>VOLUME 3</b>			
01	B1	-	-	-	BASE SAARINEN OWAL	BASE	BASE	740.0x690.0x570.0	1
<b>2200x1200</b>						<b>VOLUME 1</b>			
01	A3	-	-	-	TAMPO	TOP	SOBRE	2200.0x1200.0x25.0	1
								<b>LÂMINA / LACA / VIDRO COLADO</b>	
								2200.0x1200.0x25.0	1
<b>2200x1200</b>						<b>VOLUME 2</b>			
01	C3	-	-	-	SUPOORTE TAMPO KIT ACESSÓRIOS	TOP SUPPORT ACCESSORY KIT	SOBRE SOPORTE KIT ACESSÓRIOS	1200.0x700.0x25.0	1
Ao lado	-	-	-	-	-	-	-	-	1
<b>2200x1200</b>						<b>VOLUME 3</b>			
01	B1	-	-	-	BASE SAARINEN OWAL	BASE	BASE	740.0x690.0x570.0	1
<b>Ø800mm</b>						<b>VOLUME 1</b>			
01	A4	-	-	-	TAMPO	TOP	SOBRE	800.0x800.0x30.0	1
								<b>LÂMINA / LACA / VIDRO COLADO</b>	
								800.0x800.0x30.0	1
<b>Ø1000mm</b>						<b>VOLUME 1</b>			
01	A5	-	-	-	TAMPO	TOP	SOBRE	1000.0x1000.0x30.0	1
								<b>LÂMINA / LACA / VIDRO COLADO</b>	
								1000.0x1000.0x30.0	1
<b>Ø800mm - Ø1000mm</b>						<b>VOLUME 2</b>			
01	C4	-	-	-	SUPOORTE KIT ACESSÓRIOS	SUPPORT ACCESSORY KIT	SOORTE KIT ACESSÓRIOS	530.0x530.0x18.0	1
Ao lado	-	-	-	-	-	-	-	-	1
<b>Ø800mm - Ø1000mm</b>						<b>VOLUME 3</b>			
01	B4	-	-	-	PEÇA	BASE	BASE	470.0x470.0x710.0	1

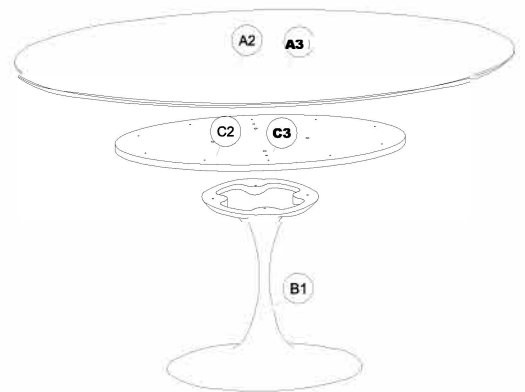
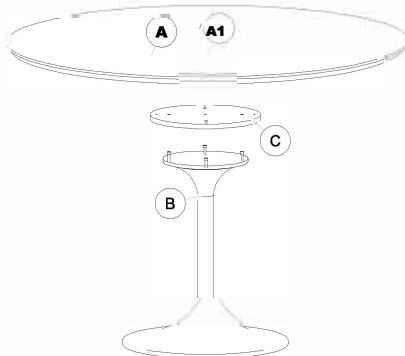
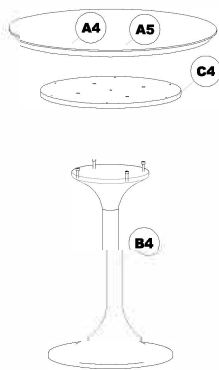

**RELAÇÃO DE COMPONENTES / PARTS LIST / LISTA DE COMPONENTES**

**CÓDIGO DO KIT:**

**KIT**

REF.	QTDE	PEÇA	PART	PIEZA	IMAGE
112	1	CHAVE ALLEN 8 MM	8MM ALLEN KEY	CLAVE ALLEN 8MM	
138	1	KIT FELTRO ADESIVO NR.6 25X204 CINZA REP.	ADHESIVE PROCTECTOR KIT	KIT ADHESIVO	
7	2	CAVILHA MADEIRA 8X30	WODEN PLUG	TARUGO	
77	10	PARAF.5 X 35 CAB.CHATA PHILIPS	Screw	Tornillo	

**Passo**  
**Step** **1**  
**Paso**

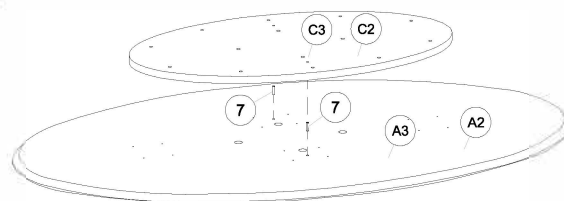
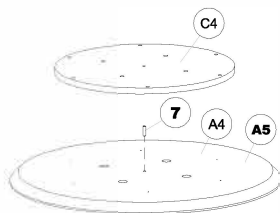
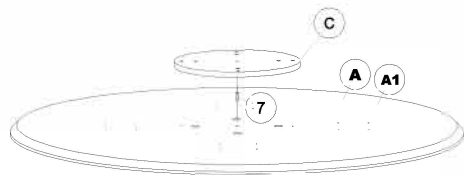

**Passo**  
**Step** **2**  
**Paso**

- Remover os parafusos.
- Remove the screws.
- Retirar los tornillos

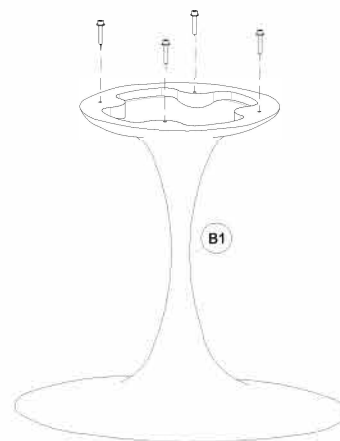
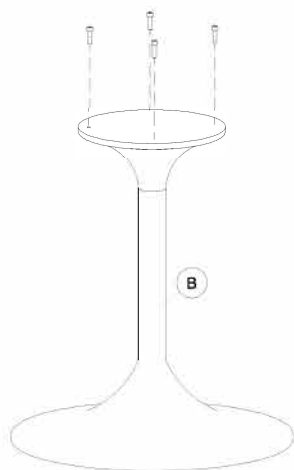
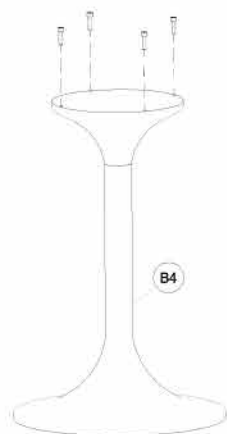

**Passo**  
**Step** **3**  
**Paso**

- Fijar bem os parafusos.
- Fix the screws.
- Fijar bien los tornillos

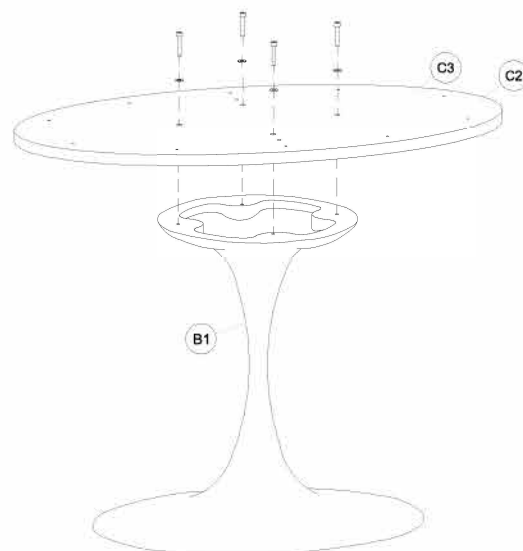
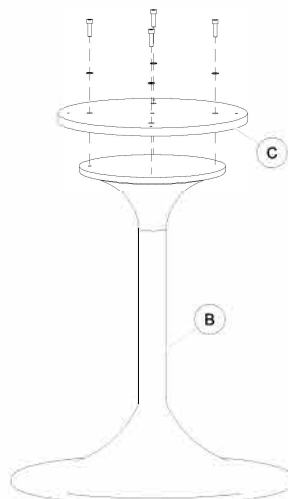
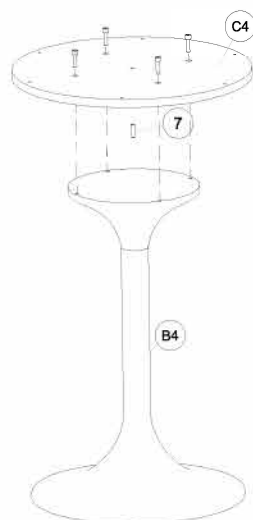

Passo  
Step **4**  
Paso

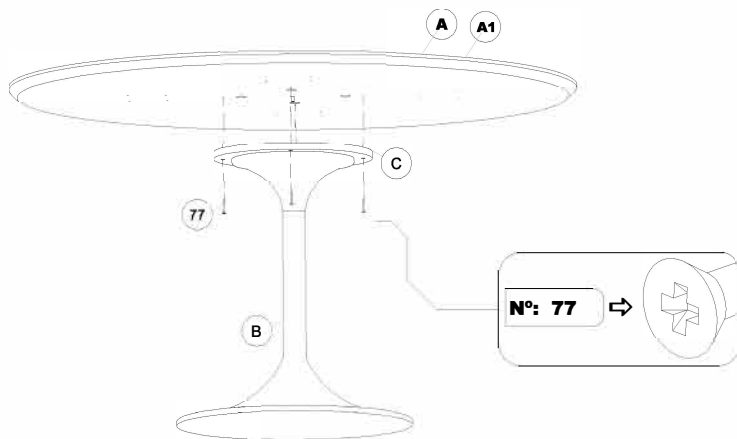

Passo  
Step **4**  
Paso

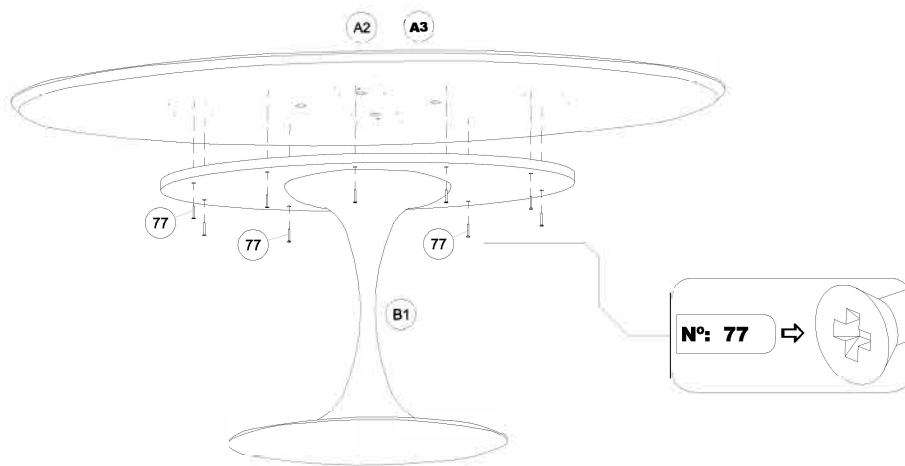

Passo  
Step **4**  
Paso

