



*Brushed Nickel finish Shown

AQUA ULTRA

Specification Features

- AQUA ULTRA SHOWER SCREEN AND SHOWER BASE KIT
- FRAMELESS CURVED DESIGN WITH A EUROPEAN STYLE
- 5/16 IN. (8 MM) THICK CERTIFIED CLEAR TEMPERED GLASS
- UP TO 1/4 IN. ADJUSTMENT FOR OUT-OF-PLUMB
- REVERSIBLE FOR RIGHT OR LEFT DOOR INSTALLATION
- SLIMLINE SHOWER BASE: LOW PROFILE THRESHOLD DESIGN
- GLOSSY ACRYLIC FINISH IS SCRATCH AND STAIN RESISTANT



Technical Information

- Model: Aqua Ultra
- Door Type: Swing Door
- Kit Dimensions: 36" D x 48" W x 74 3/4" H
- Product Width: 48"
- Product Depth: 36"
- Glass Thickness: 5/16 in. (8 mm)
- Glass Type: Clear
- Base Color: White

Codes/Standards Applicable

- ANSI Z97.1 (Tempered Glass)
- 16 CFR Part 1201
- cUPC Certified Base

Hardware Finish Options:

-  01 - Chrome Finish
-  04 - Brushed Nickel

Model SKU#s:

- DL-6524C-01CL Center Drain White Base Kit
- DL-6524C-04CL Center Drain White Base Kit

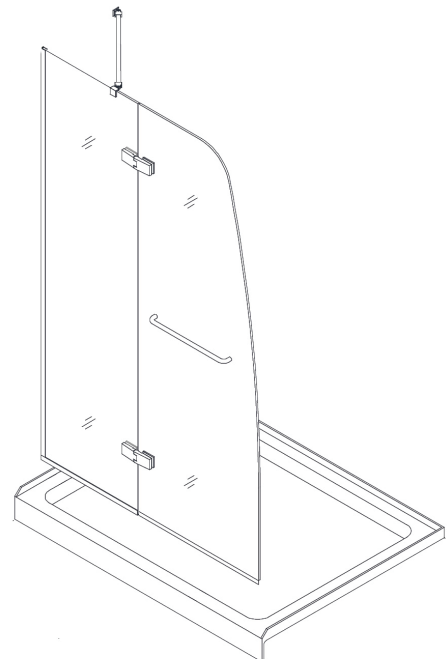

Available Product Configurations:

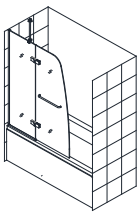

Tub Door

Model #:
SHDR-3448580-01
SHDR-3448580-04
SHDR-3448580-06
SHDR-3448580-09

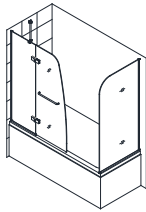

Tub Door with Return Panel

Model SKU#s:
SHDR-3448580-RT-01
SHDR-3448580-RT-04
SHDR3448580RT06
SHDR3448580RT09

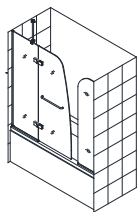

Tub Door with Extender Panel

Model SKU#s:
SHDR-3448580-EX-01
SHDR-3448580-EX-04
SHDR3448580EX06
SHDR3448580EX09

36" D x 48" W Shower Door + Shower Base Kit

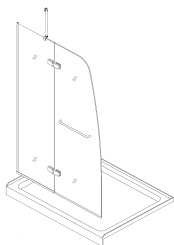

Model #s:
DL-6524C-22-01 Biscuit Shower Base Kit
DL-6524C-22-04 Biscuit Shower Base Kit

DL-6524C-88-01 Black Shower Base Kit

Important Notes:

If this unit is going to be installed in a new construction, please, install all of the required plumbing and drainage before installing the shower. Use a competent and licensed plumber for all plumbing installation period.

Install this product according to the installation manual.

Anodized aluminum U-channel allows up to 1/4 in. adjustment for out-of-plumb (uneven walls).

Stationary panel requires a Support Arm for additional stability.

Drain opening fits any standard 2 in. compression fitted drain (drain not included).

Professional installation recommended; Drilling into the threshold is required for installation of this product.

Important Disclaimers:

- Prior to installation, please ensure that the installation surface is finished, level and solid and will be able to support the total weight of the unit. Also, make sure that the walls are plumb. Irregular installation, surface level or out of square conditions can result in serious problems for your installation.
- Please read Installation Manual thoroughly prior to installing this product.
- Please note that you should consult your local building codes with questions on installation compliance standards. Building and plumbing codes may vary by location, and DreamLine® is not responsible for code compliance standards for your project and will not accept any returns.

For commercial customers, we strongly recommend the use of Dreamline's Onsite Contractor Support option.

Dreamline's commercial warranty does not apply to damage or losses resulting from (i) other than normal and proper use and normal service conditions; (ii) improper installation, (iii) installation in or upon an unsuitable surface or areas; (iv) abuse, (v) accident, (vi) alteration, (vii) misuse, (viii) neglect, (ix) unauthorized repair or the failure to utilize suitably qualified and trained persons to perform service and/or repair of the Product, (x) improper maintenance, (xi) failure to follow installation, operating, cleaning or maintenance instructions, and (xii) use of "non-authorized" parts.