

# Assembly Instructions

**Caution: You must read this before you proceed**

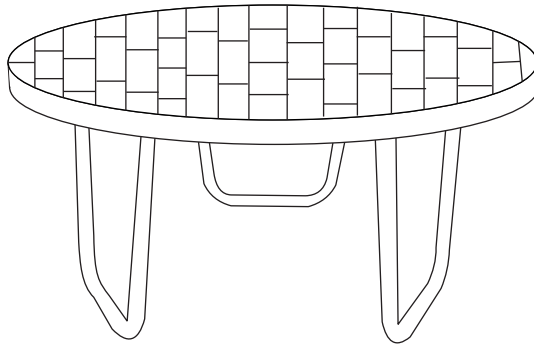

## COFFEE TABLE

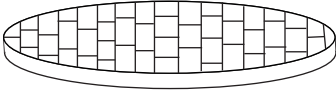
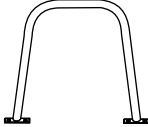

### Parts List

Label	Picture	Description	Qty
A		Table Top	1
B		Metal Leg	3

### Hardware

Label	Picture	Description	Qty
①		Washer	14
②		Nut	14
③		Spanner	1

# Assembly Preparation

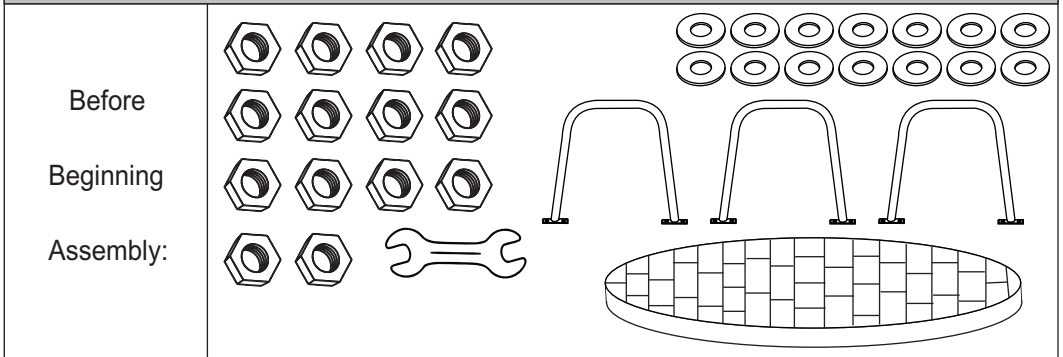

• Read instructions, cover to cover—



• Have 2 adults on hand for assembly—



• Do not assemble on flooring or carpet—



• Assemble on a clean non-marring surface (packing foam)—



• Save all packaging until finished—

# Assembly steps

## Overview

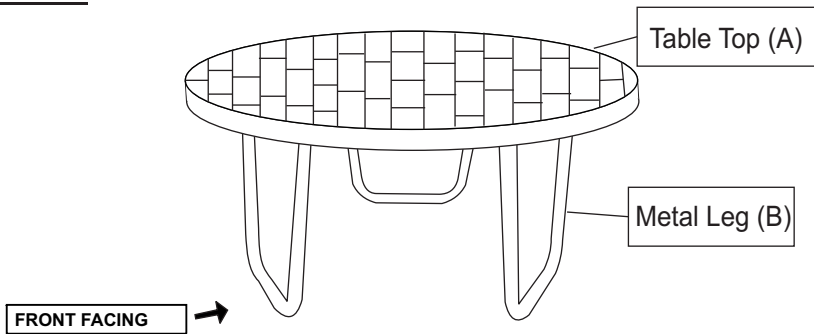

This Coffee Table has multiple parts and may require up to some 30 minutes to assemble. The above picture is to help you in putting various parts into perspective. Please read through the instructions below to familiarise yourself with the parts and steps before assembly.

## Step 1

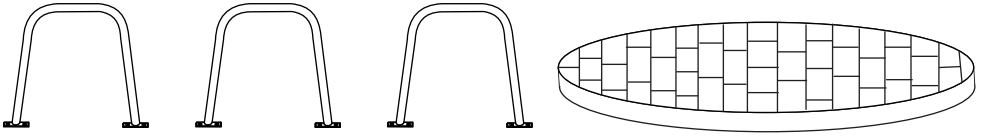

Unpack all the parts and place them on a clean non-marring surface.

## Step 2

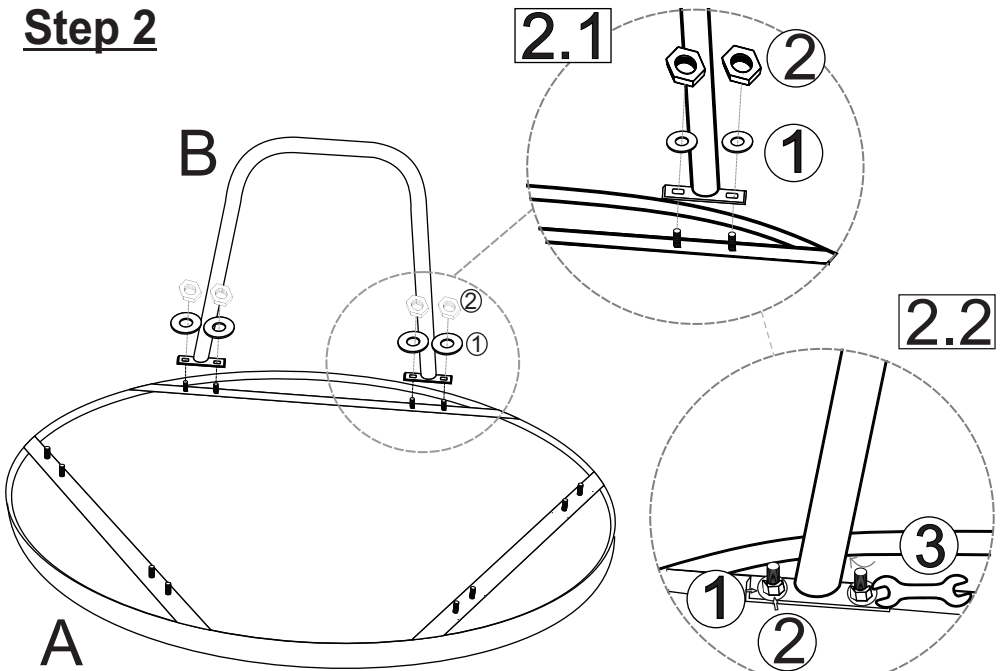

With help of your adult partner, carefully put the Table Top (A) upside down:

**Step 2.1** - Attach Metal leg (B) to Table Top (A) using Washer(①), Nut(②).

**Step 2.2** - Fix the nut with the help of the spanner (③)



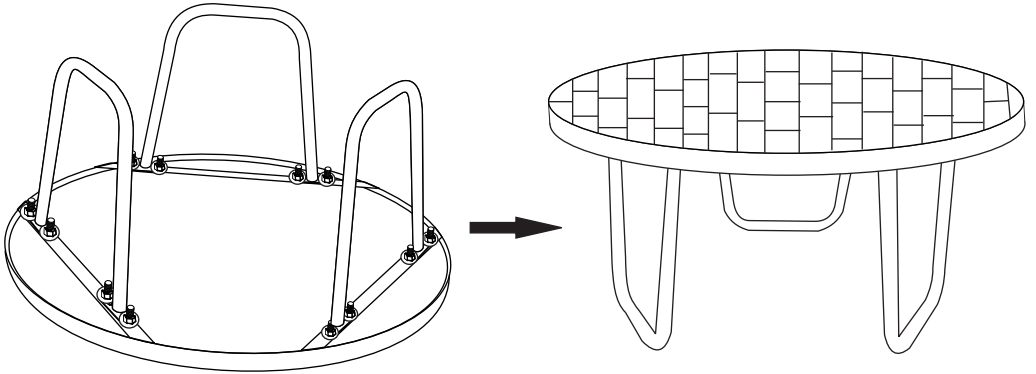







### Step 3



Repeat step 2.1 and 2.2 to attach other two Metal legs (B) to Table Top (A).

Turn the Coffee Table and it is now ready to use  
**Caution: This Coffee Table can only be used on flat, level surface.**

## Care & Maintenance

- ✓  • Furniture may scratch floors. We recommend using furniture pads to protect your floors.
- ⊘  • Do not put hot items directly on furniture surface.
- ⊘  • Do not clean furniture with harsh cleansers or polish.
- ⊘  • Do not place furniture under direct sunlight.
- ⊘  • Do not place furniture near heating or cooling vents.
- ⊘  • Do not write on furniture without a padded barrier to protect the surface.
- ⊘  • Do not place furniture outside . For indoor use only.
- ⊘  • Not for commercial use. For residential use only.
- ⊘  • Stains may be removed with mild soap solution and damp cloth.
- ⊘  • Children should not climb or jump on the furniture.
- ✓  • Dust and pick-up spills using a clean, non-colored, lint-free cloth.