

3 Piece Bar Table Set



EN: When assembly, do not tighten the screws one by one first until making sure all the corresponding screws are placed in the right positions.





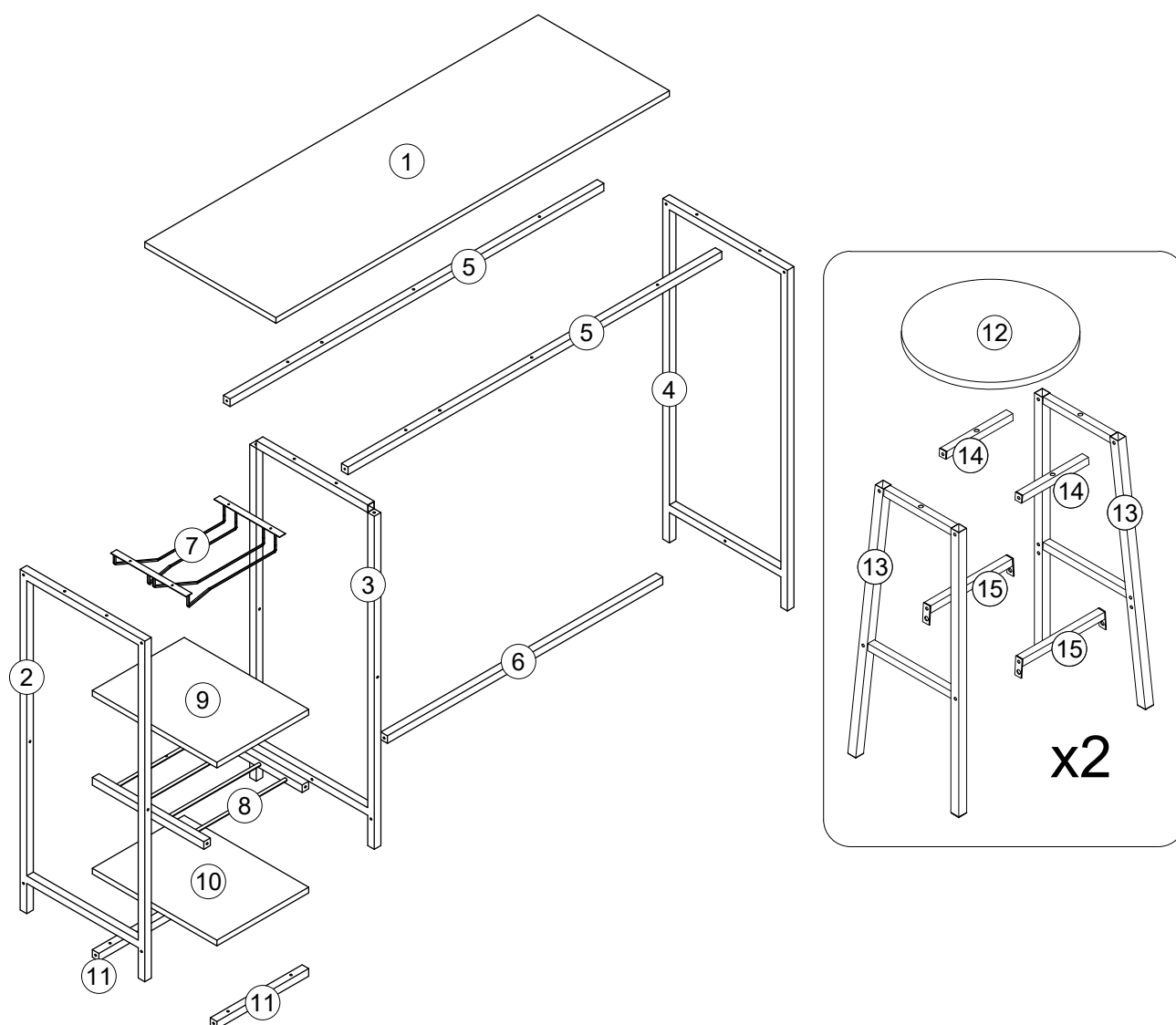

DE: Bitte achten Sie beim Zusammenbau darauf, dass alle entsprechenden Schrauben in der richtigen Position angebracht sind, und ziehen Sie die Schrauben dann nacheinander fest.

IT: Durante il montaggio, assicurarsi che tutte le viti corrispondenti siano installate nella posizione corretta, quindi serrare le viti una per una.

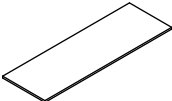
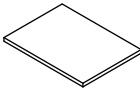
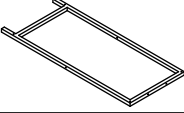
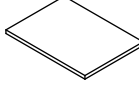
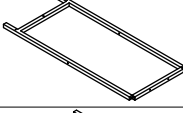
FR: Lors du montage, assurez-vous que toutes les vis correspondantes sont installées dans la bonne position, puis serrez les vis une par une.

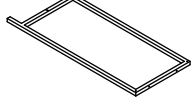
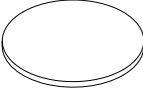
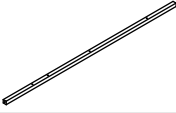
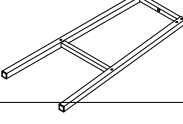
ES: Al ensamblar, primero asegúrese de que todos los tornillos correspondientes estén instalados en la posición correcta y luego apriete los tornillos uno por uno.

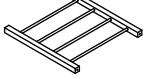

①		x1	⑨		x1
②		x1	⑩		x1
③		x1	⑪		x2
④		x1	⑫		x2
⑤		x2	⑬		x4
⑥		x1	⑭		x4
⑦		x1	⑮		x4
⑧		x1			

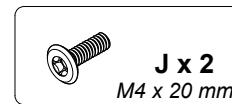
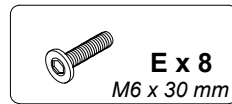
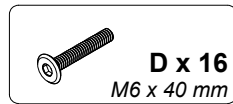
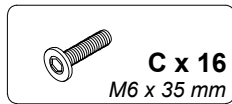
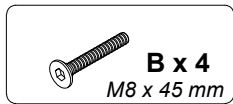
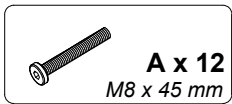

1

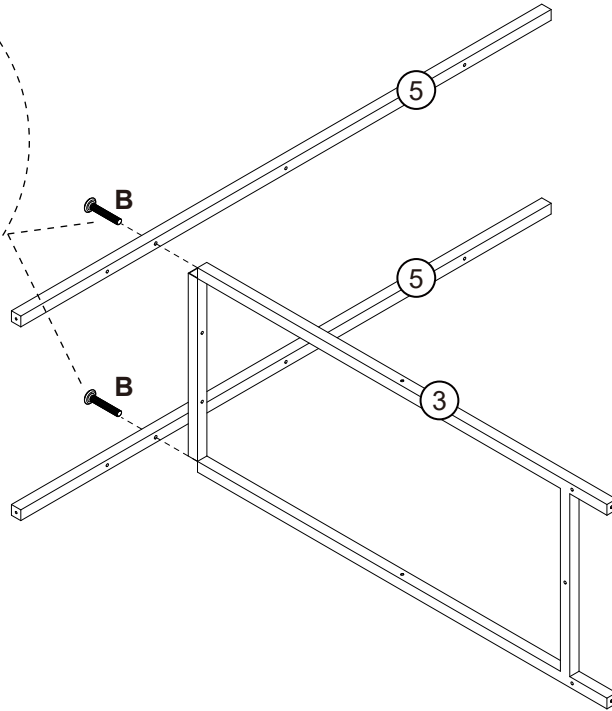
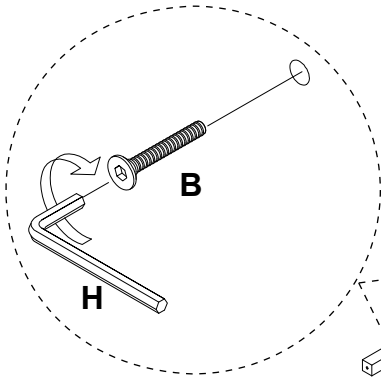
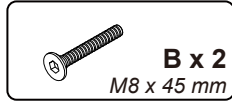
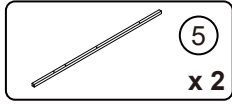
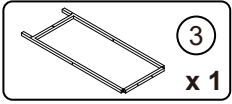

2

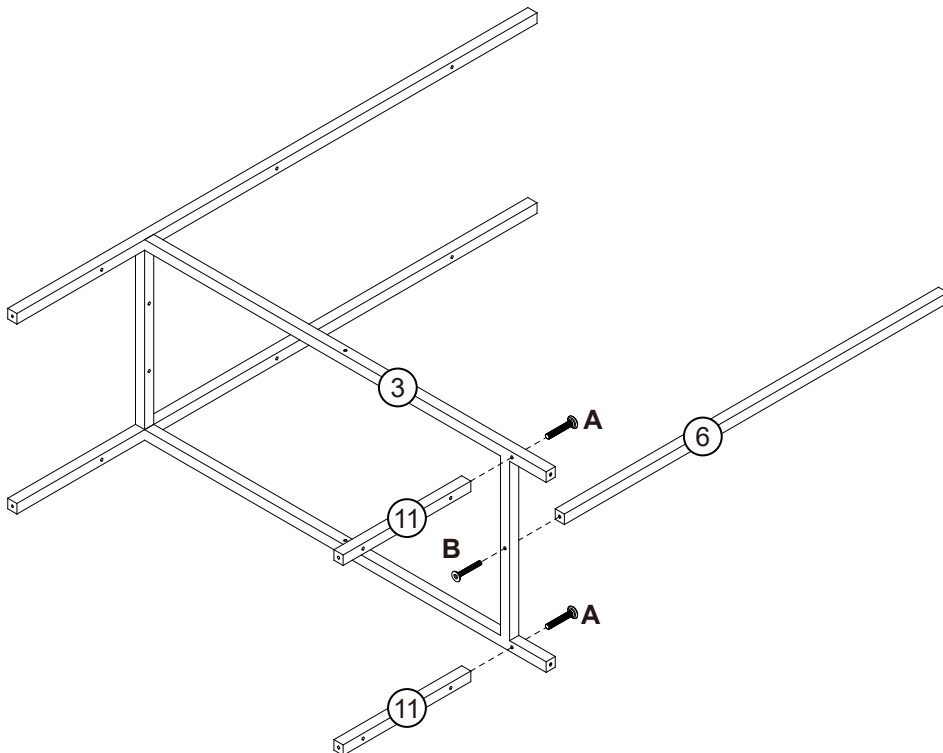
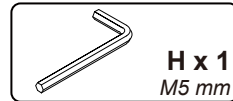
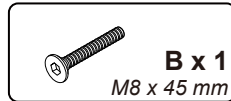
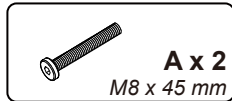
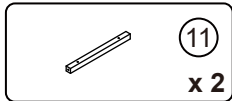
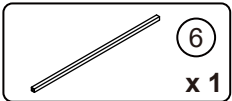

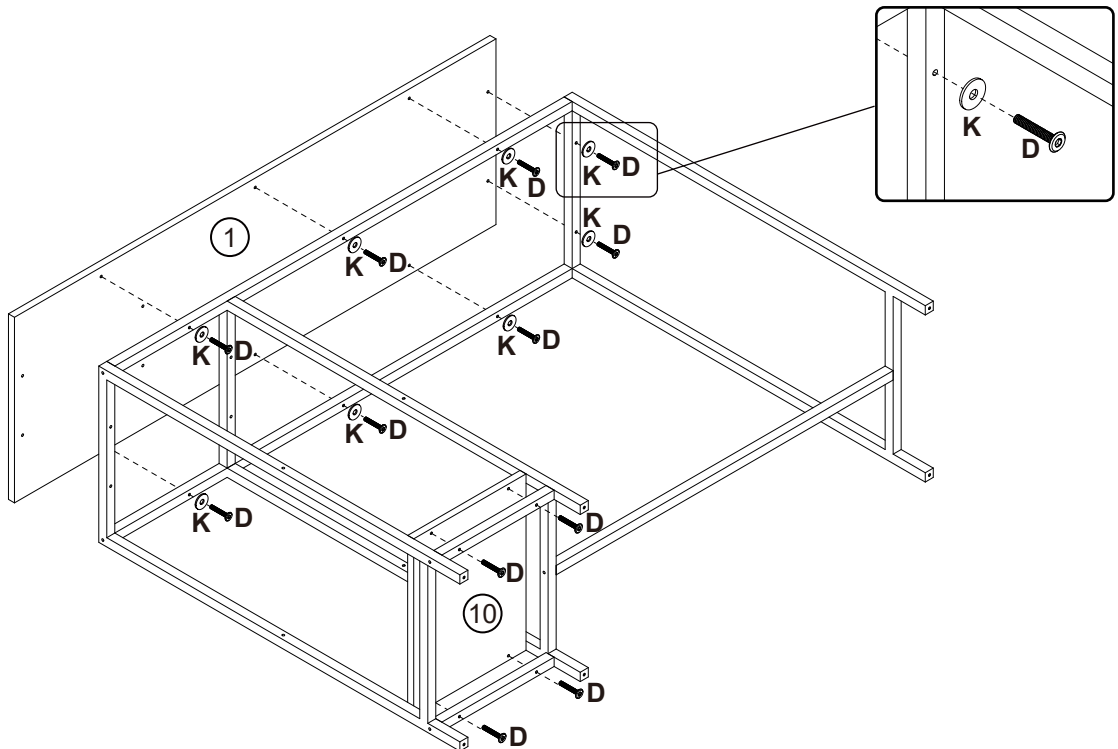
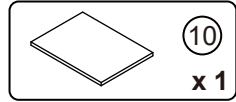
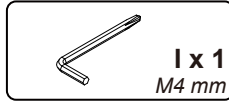
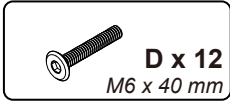
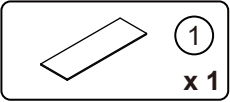
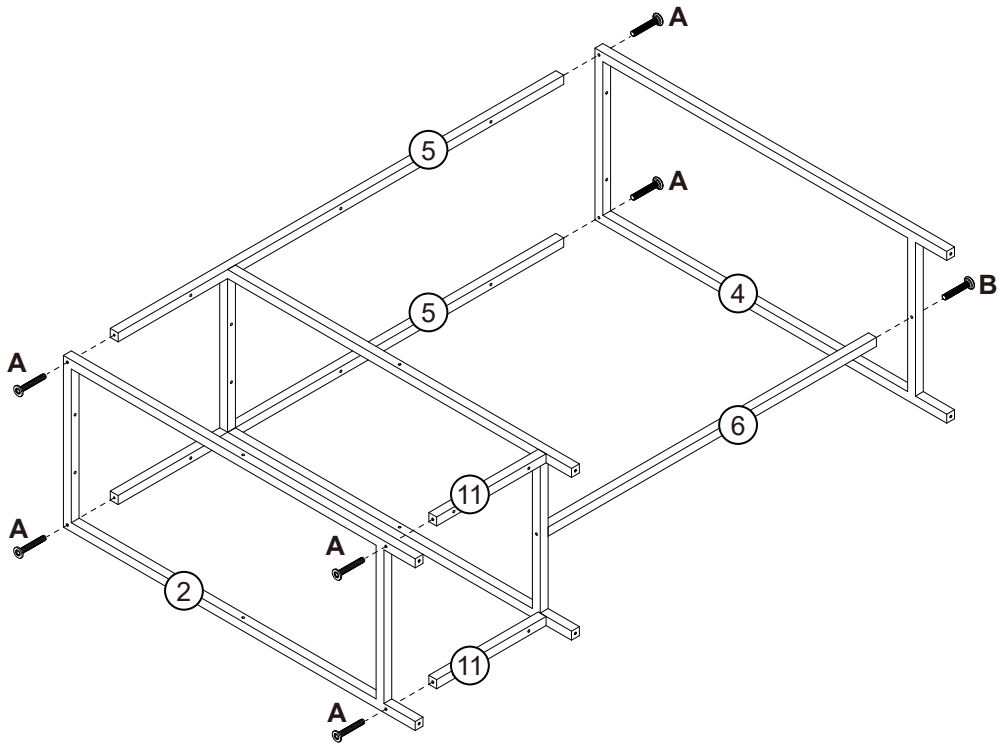
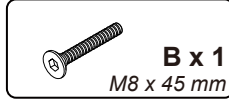
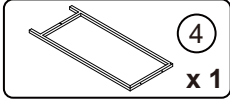
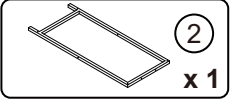

5

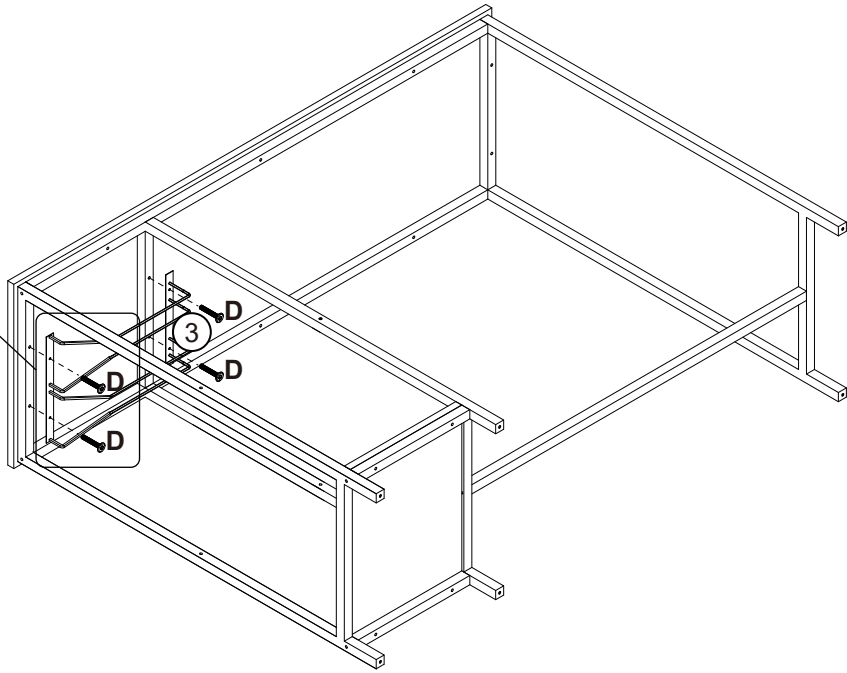
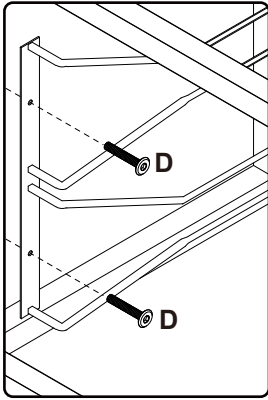
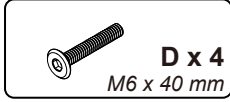
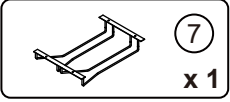

6

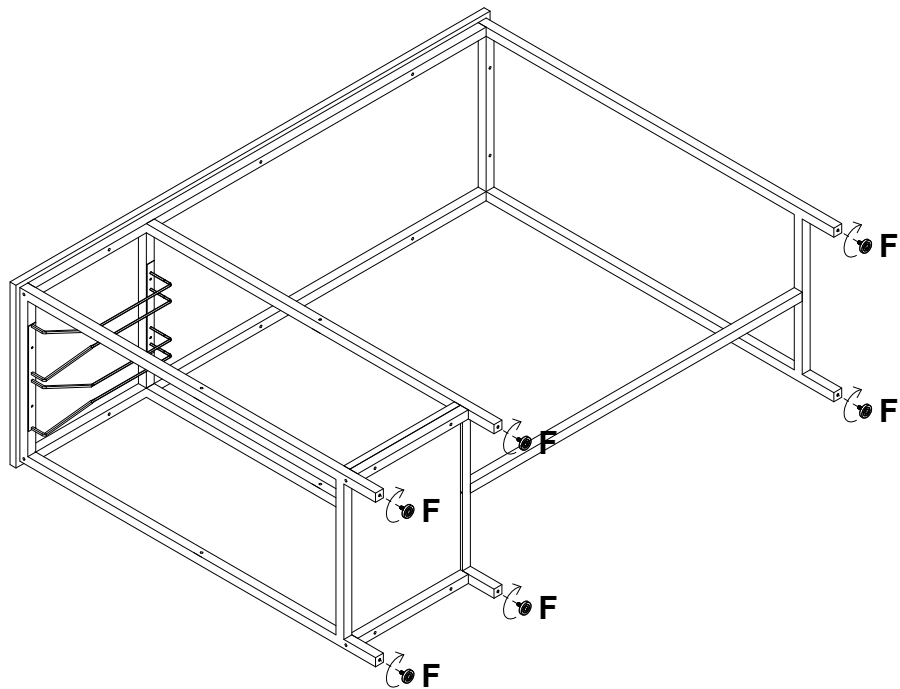

7

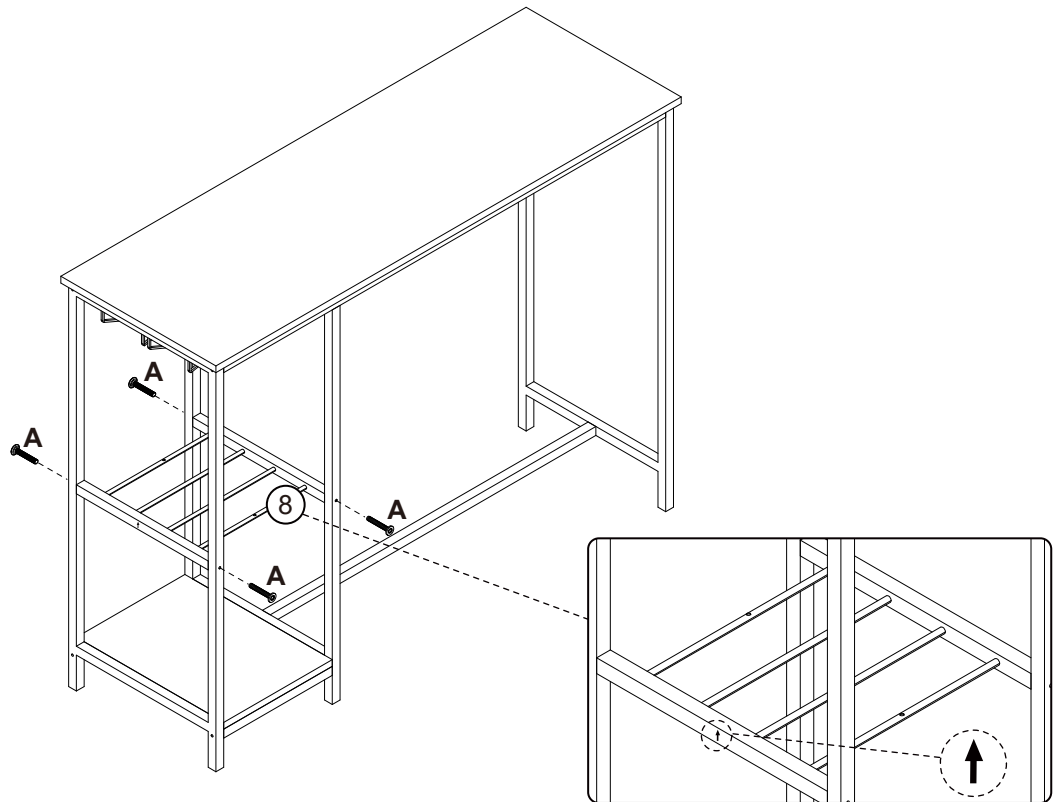
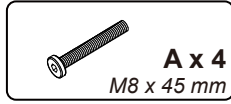
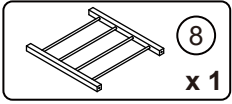

8

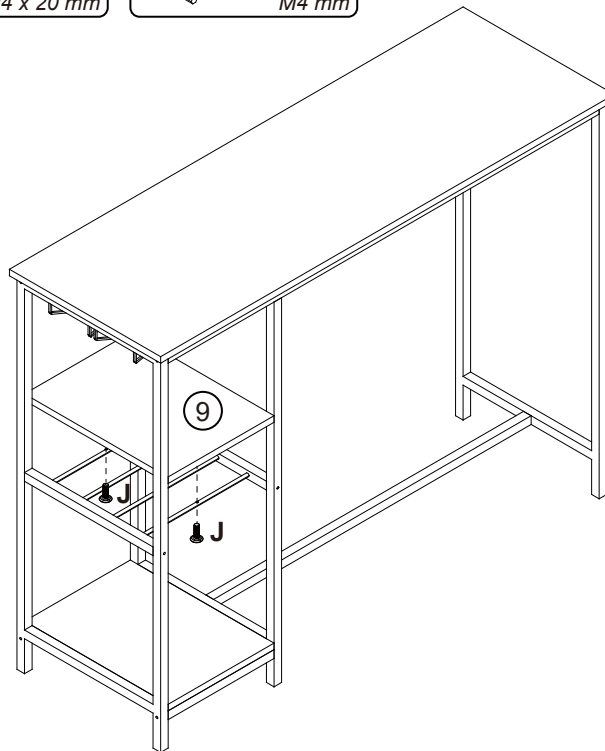
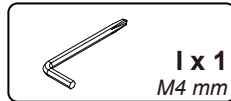
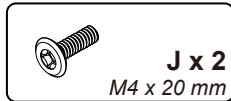
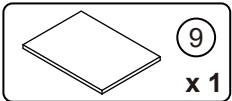

EN: You can decide whether to install No. 9 board according to your needs.

DE: Sie können entscheiden, ob Sie die Platine Nr. 9 entsprechend Ihren Anforderungen installieren möchten.

ES: Puede decidir si instalar la placa n.º 9 según sus necesidades.

FR: Vous pouvez décider d'installer la carte n.º 9 en fonction de vos besoins.

IT: Puoi decidere se installare la scheda n. 9 in base alle tue esigenze.

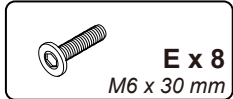
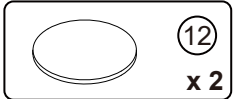
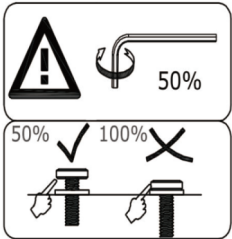
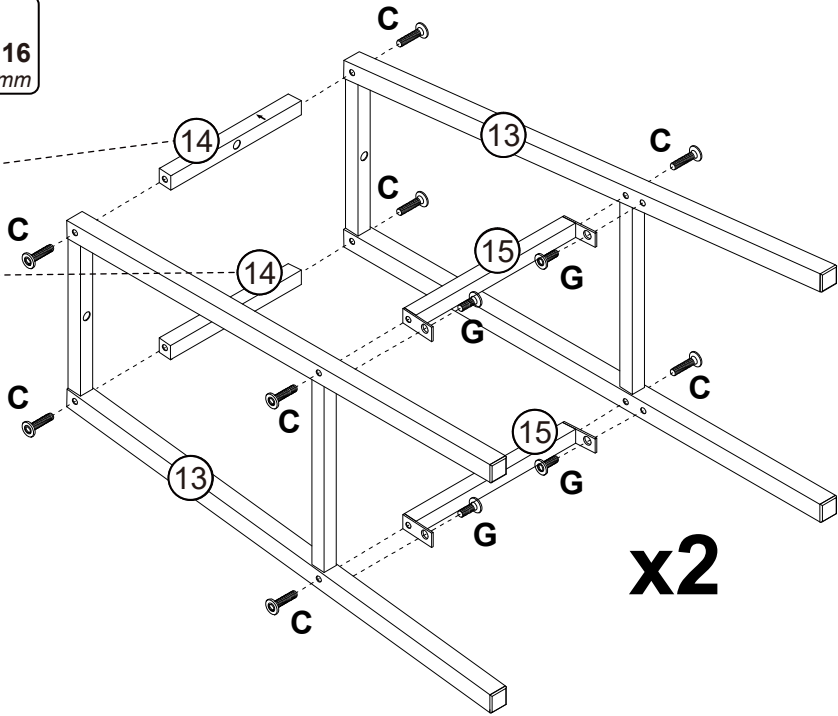
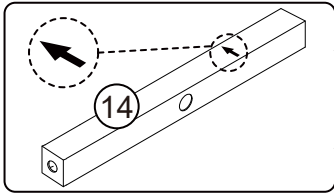
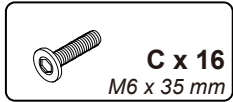
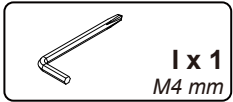
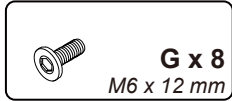
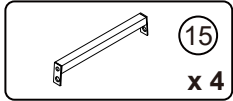
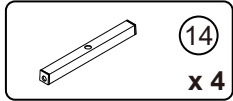
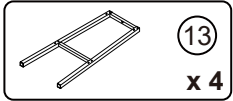

EN: The stool board adopts silver type E, please pay attention to the size of the screws.
 DE: Das Hockerbrett ist in Silber vom Typ E ausgeführt, bitte achten Sie auf die Größe der Schrauben.
 IT: Lo sgabello adotta il tipo E argento, prestare attenzione alle dimensioni delle viti.
 FR: Le tabouret adopte l'argent de type E, veuillez faire attention à la taille des vis.
 ES: El tablero del taburete adopta el tipo E plateado, preste atención al tamaño de los tornillos.

