



MAKE SEWING EASIER  
REACH EMBROIDERY CLOSER

**POOLiN**

# User Manual

EOC05 Embroidery Machine



EOC05

 Richword(Wuxi)Supply Chain Management Co.,Ltd

 (+86)0510 83380568

 poolinservice@richword.com

 Room 1601, Jianghai West Road, Liangxi District,  
Wuxi City, Jiangsu Province, China

Please contact us before the first use to avoid  
operating errors and damaging the machine.

# CATALOG

Function introduction	01
Threading	03
Bobbin winding and installation	04
Embroidery	06
USB input	11
Solve problems quickly	13

## Function introduction

■ Front view



- 1.Liquid crystal display screen
- 2.The handwheel
- 3.Bobbin winder
- 4.Upper thread tension adjustment button
- 5.Wire hook
- 6.Winding tension guide plate
- 7.Cutter
- 8.Embroidery unit
- 9.Quick threading device
- 10.Presser foot
- 11.Foot lifting lever
- 12.Usb interface
- 13.Debug interface  
(please do not use)
- 14.power switch
- 15.power line socket
- 16.Vents

■ Side view



## Embroidery unit

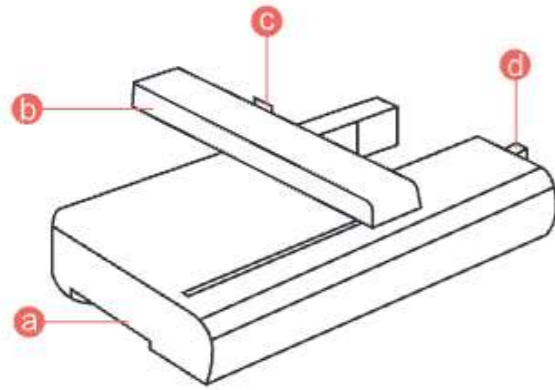

- a. Embroidery unit release handle
- b. Guide rail
- c. Embroidery frame connecting groove
- d. Embroidery unit connecting socket

## Operation buttons

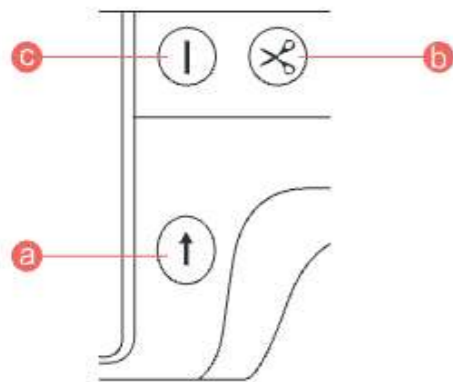

- a. Start/stop button
- b. Cutting button
- c. Pointing button(needle position up/down)

## Accessories

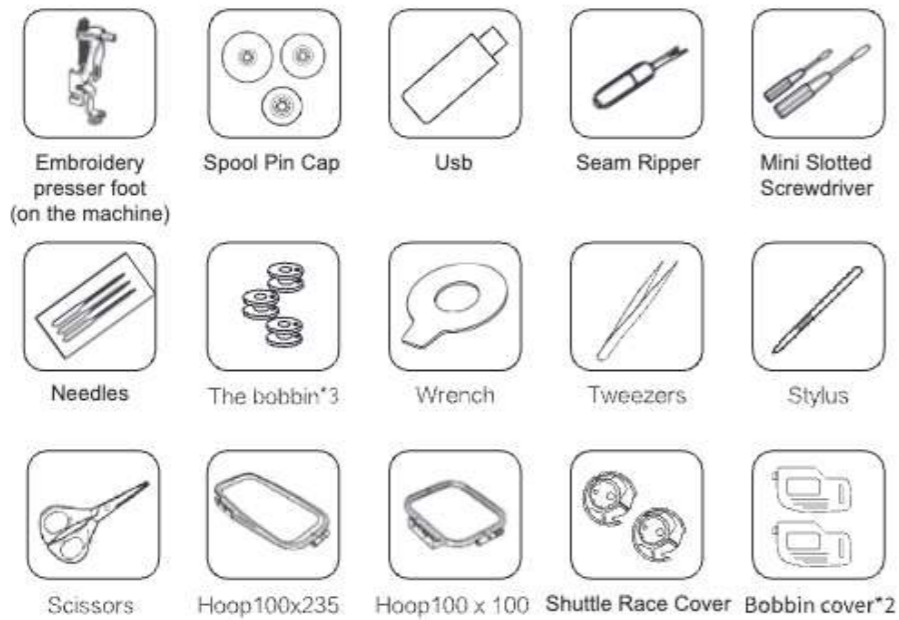

## Threading

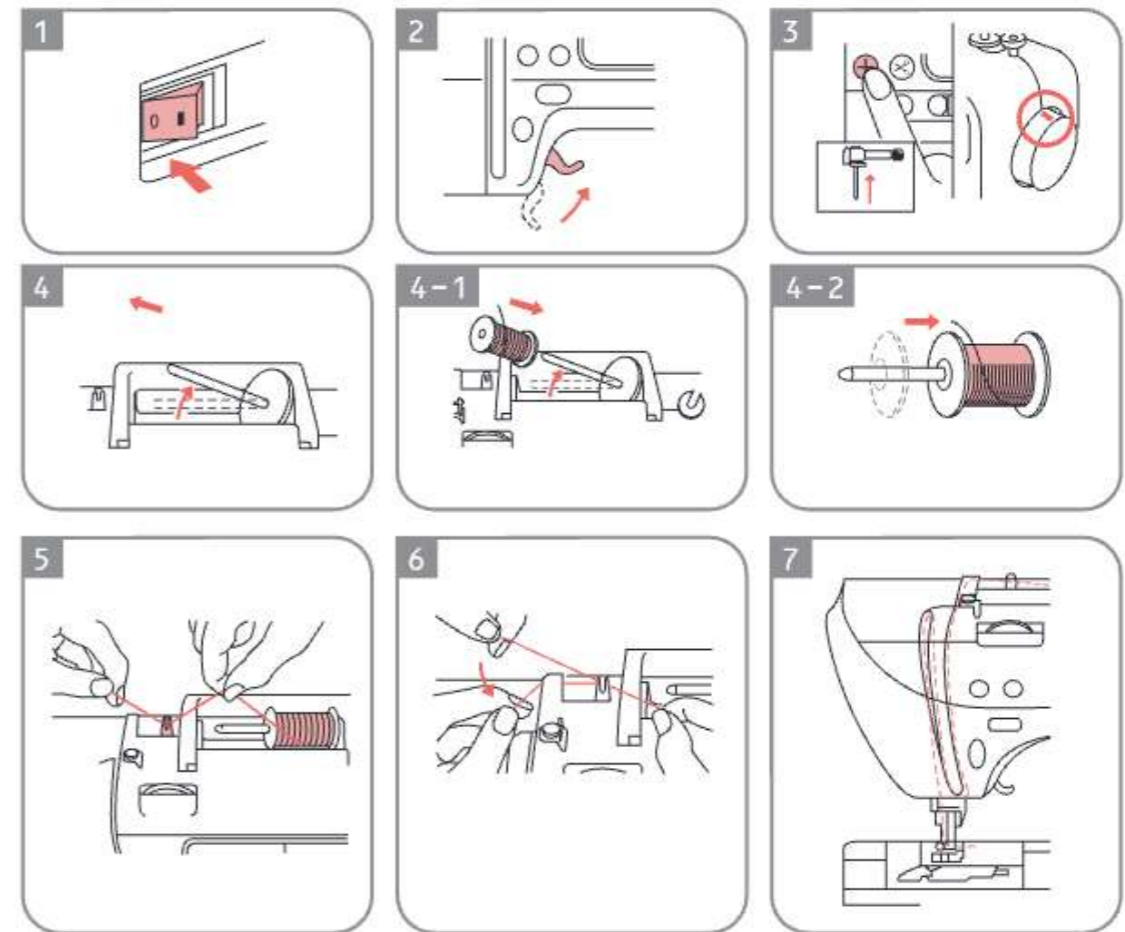
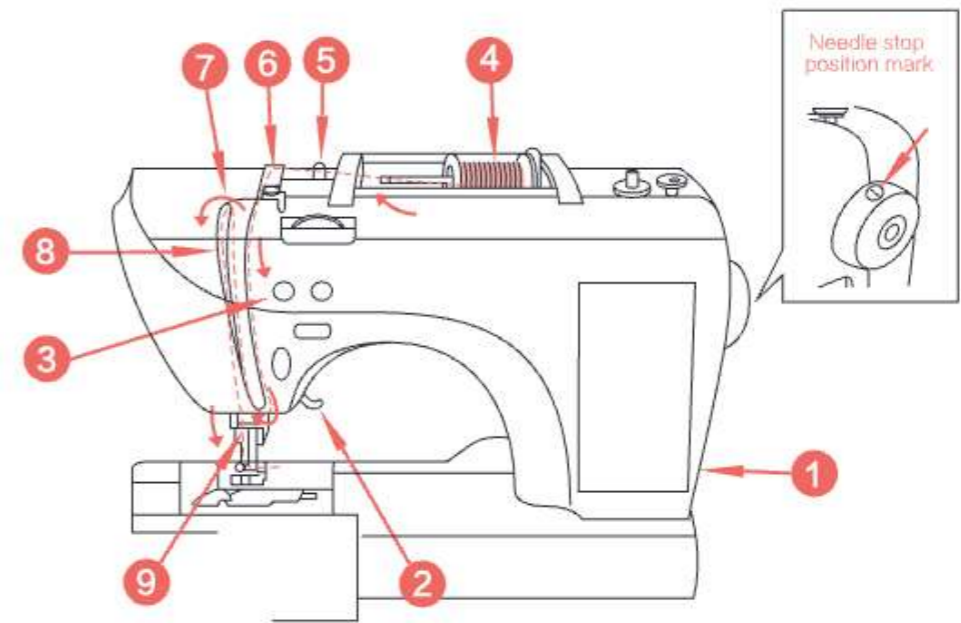

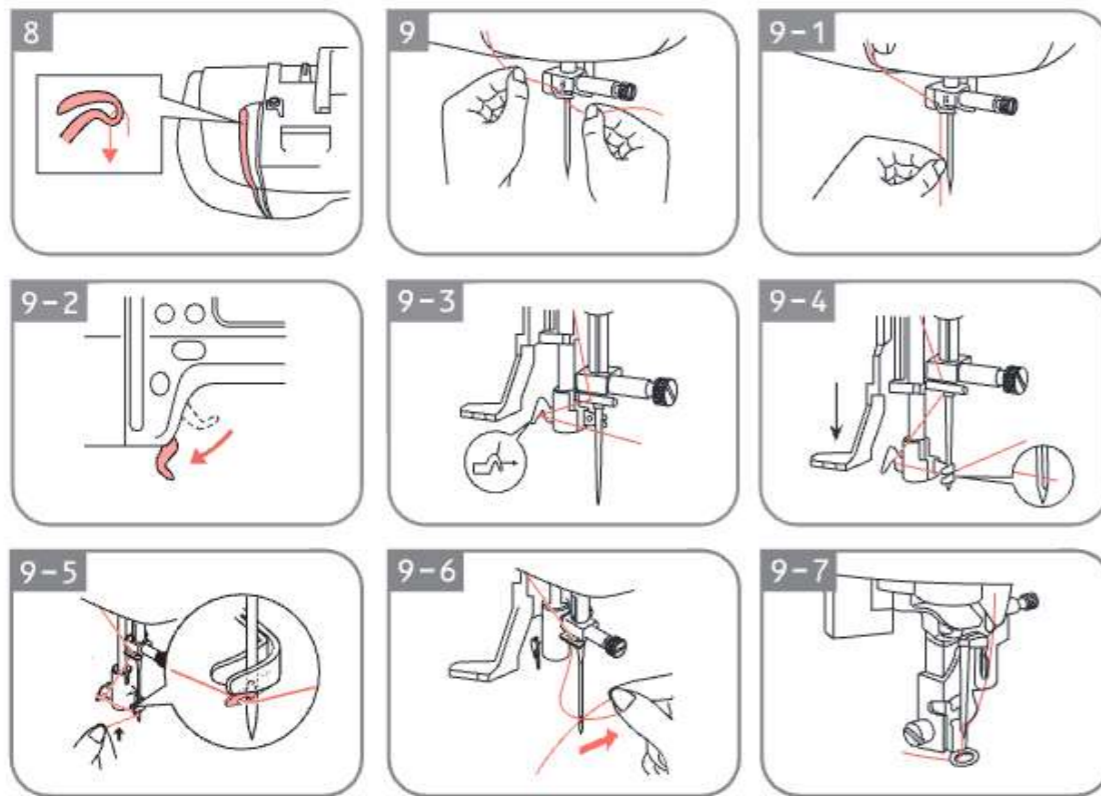

### Bobbin Winding and Installation

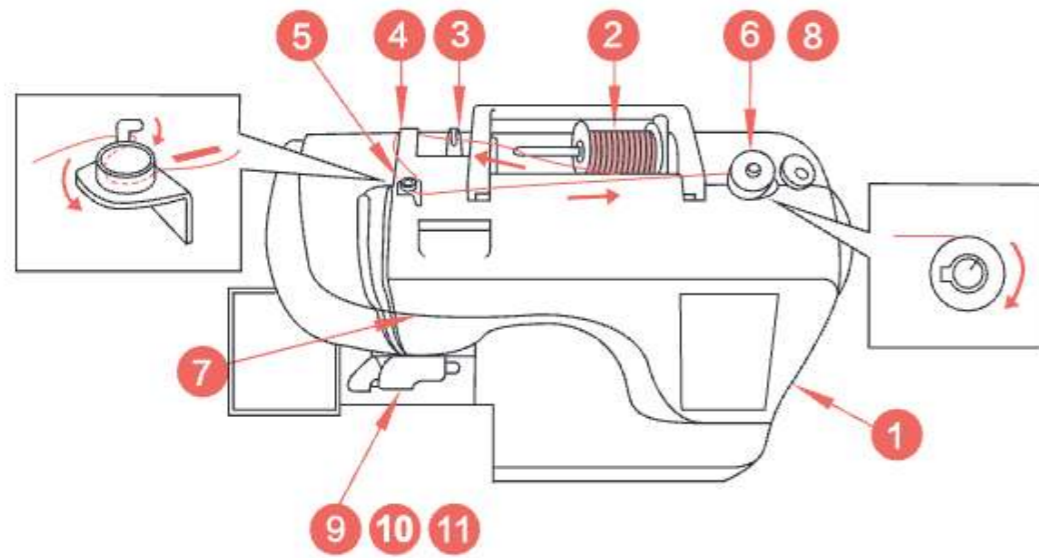

▲: Please use accessory bobbin or other bobbin with same size.

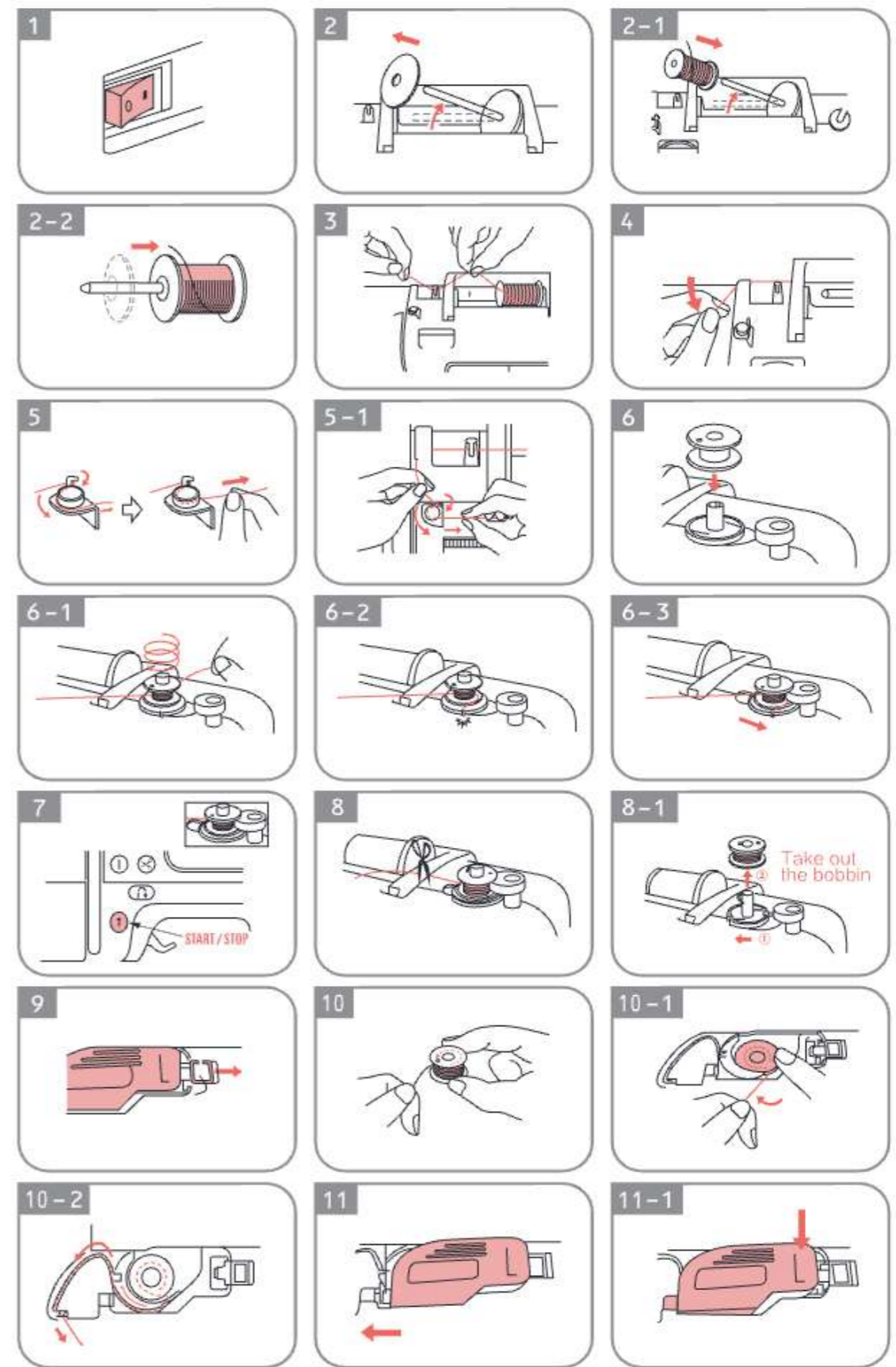
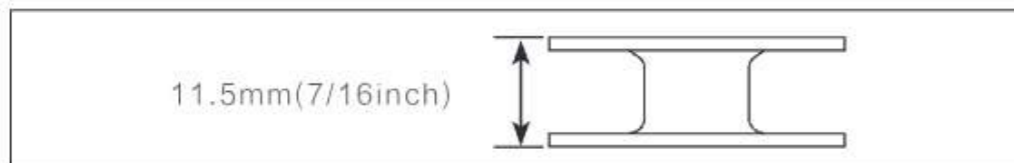

## Embroidery

▲ : The user must use embroidery presser foot.

※ : When embroidering, users should choose and use appropriate embroidery thread according to different fabrics and embroidery patterns. When using different specifications and models of embroidery thread, the embroidery effect is also different. Users are recommended to use qualified embroidery thread.

### Embroidery preparation

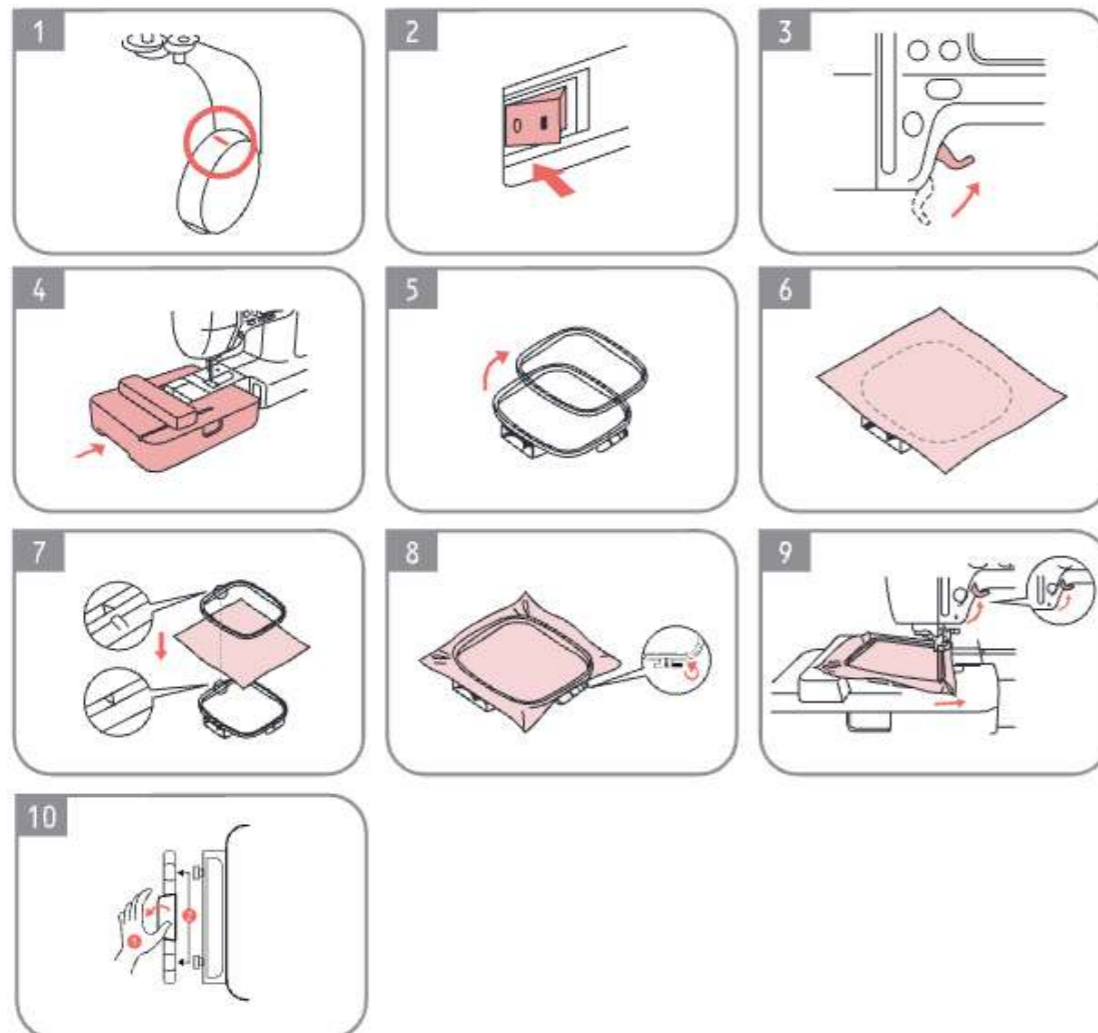

### Select pattern

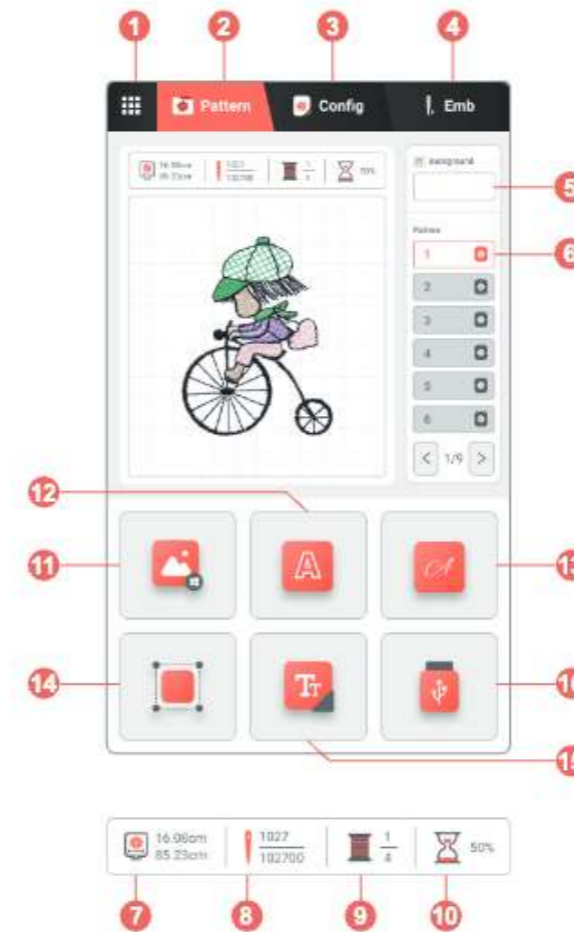

Turn on the power to enter this interface to select the pattern

- 1.Setting
- 2.Select interface
- 3.Edit pattern
- 4.Embroidery
- 5.Background color
- 6.Pattern List
- 7.Pattern size
- 8.Number of stitches
- 9.Pattern color
- 10.Embroidery progress

### Pattern Introduction

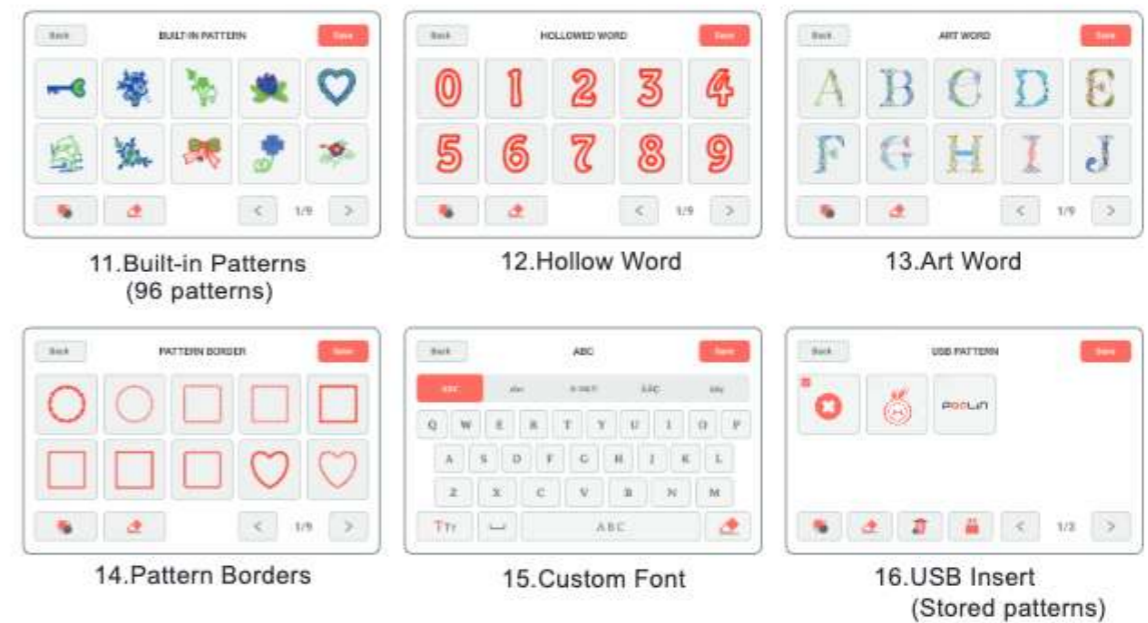

## Pattern Editing Interface



### a. Pattern combination buttons

1. Combination pattern editing
2. Single pattern editing

#### TIPS

When you select more than one pattern  
Click **"GROUP"** to adjust all patterns;  
Click **"SINGLE"** to adjust individual patterns.

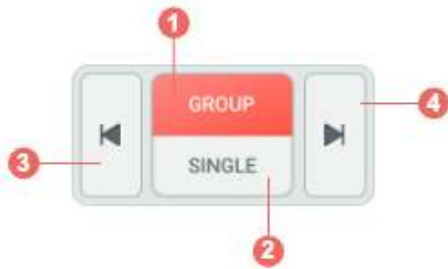

### b. Position adjustment button

1. Move to the center
2. Direction button (keep pressing button)

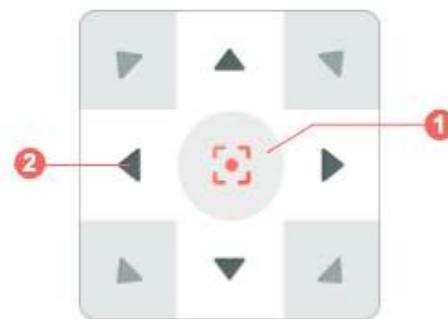

### c. Function buttons

1. Color selection  
(When the selected embroidery has two or more colors, you need to match the color on the screen with the color of design)
2. Embroidery frame selection
3. Pattern rotation
4. Font spacing  
(custom fonts only)
5. Pattern size
6. Pattern mirroring
7. Pattern initialization
8. Pattern storage
9. One click clear

▲: After completing specific editing and clicking save, the machine will make a beep sound, which means the edit is successful, you can click back to upper level interface.

Once you have edited your pattern, please check in the select frame whether your actual embroidery frame is the same as the one selected by the screen.

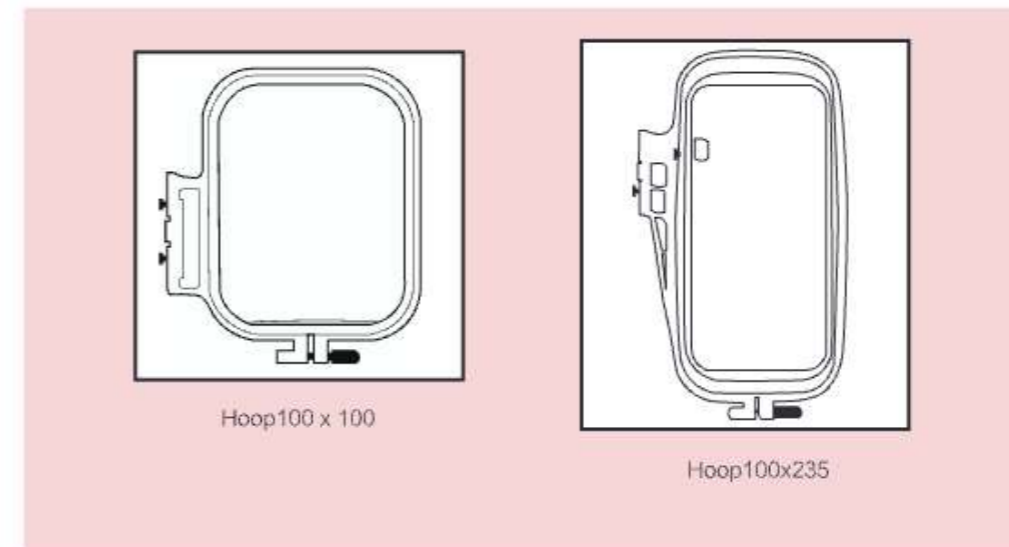

## Embroidery



1. After editing the pattern, click the top EMB button.

2. Enter the pattern embroidery page, and then click "ready", when all the editing is done.

3. Click the "Start/Stop" button on the machine to embroider.

1 Operation status: pause, running

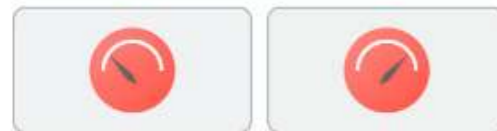

2 Speed down

3 Speed up

1 Add/back stitches



3 Follow the pattern frame

2 Add/back colors



4 Back to the starting point of embroidery



### TIPS:

When the machine is embroidering the pattern, it will stop automatically after each color embroidery and wait for the thread change.

After the embroidery is completed, pick up the presser foot and take off the embroidery frame to complete the embroidery operation.

## USB input

This machine supports input custom patterns in DST and DSB formats. Please use letters or numbers 1-9 for the file to name custom pattern, and store the pattern in the root directory of the U disk.

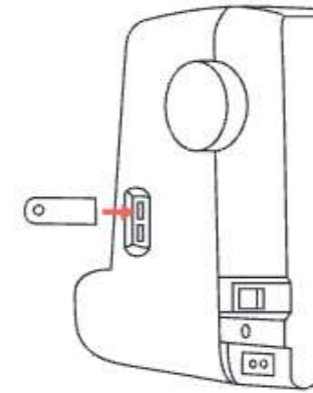

Insert USB

1



Click the USB button

2

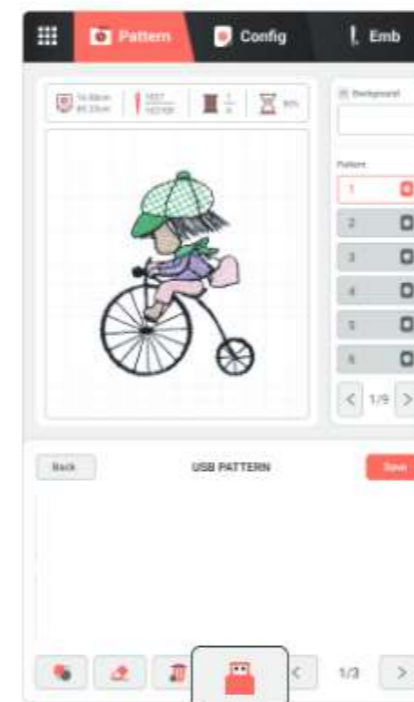

Click the USB input button

3

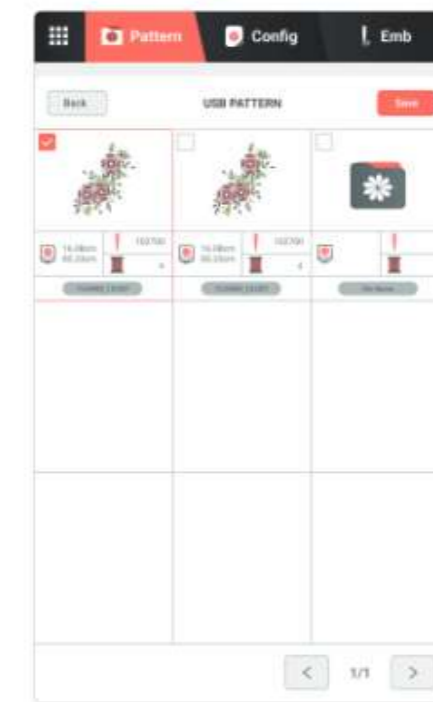

Select the pattern and click save

4

Our USB comes with full and clear teaching and after-sale videos.

If you have any questions while reading the instructions or using the machine, you can check out the videos in USB.

## Setting

Click to  enter the settings interface



Menu



Language Settings

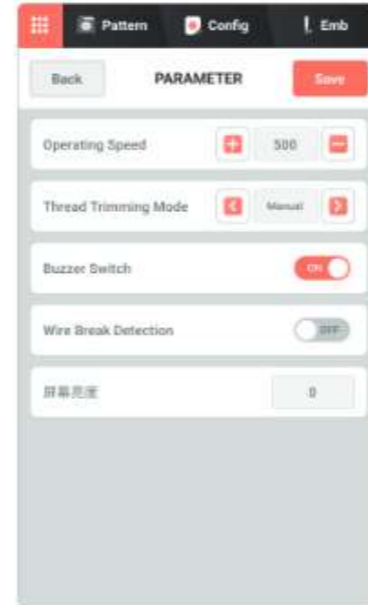

Parameter Settings



System Upgrade



Engineer Parameters



Services

## Solve problems quickly

### 01 Unlock the thread

**Cause1: The embroidery thread is not installed correctly**

Solution1: re-thread the embroidery thread according to the manual and body instructions. Please refer to P4-5 threading for details.

**Reason2: Bobbin not installed**

Solution2: Reinstall the bobbin, and the bobbin thread is turned out counterclockwise.

**Reason3: The position of the iron sheet of the presser foot is wrong**

Solution3: readjust the position of the presser foot iron.

**Reason4: Incorrect position of rotary shuttle**

Solution4: readjust the rotary shuttle to the correct position for more information, please refer to the video "How to handle unlock the thread" in our USB.

### 02 Keep reminder re-thread

**Reason: too loose tension**

Solution: Re-thread as directed first, then adjust the tension to 3-4.

For more information, please refer to the video "How to handle keep reminder re-thread" in our USB.

### 03 Upper thread broken

**Reason1: The upper thread tension is too tight**

Solution1: After adjusting the tension of the upper thread to 3-4, then re-thread. Please refer to P4-5 threading for details.

**Reason2: The upper thread winding is not correct**

Solution2: Rewind the thread according to the fuselage instructions and instructions. Please refer to P4-5 threading for details.

**Reason3: The bobbin case is damaged**

Solution3: Replace with a new bobbin case, and rewind the thread according to the body instructions and instructions, Please refer to P4-5 threading for details.

For more information, please refer to the video "How to handle upper thread broken" in our USB.

04

## Needle broken

**Reason1: The upper thread winding is not correct**

Solution1: re-thread the embroidery thread according to the manual and body instructions. Please refer to P4-5 threading for details.

**Reason2: The upper thread tension is too tight**

Solution2: After adjusting the tension of the upper thread to 3-4, then re-thread, Please refer to P4-5 threading for details.

**Reason3: No bobbin installed**

Solution2: Install the bobbin according to the instructions on the fuselage, and turn the bobbin thread counterclockwise.

After completing the above operation and then replace the embroidery needle.

For more information, please refer to the video "How to change needle" in our USB.

**Tips:** The standard needle type of our machine is sewing machine needle HAX1 90/14. In order to pursue better embroidery effect, you can choose different embroidery needles when embroidering different patterns and fabrics. For some small patterns, small pattern corners or thin fabrics, you can choose a smaller needle. For thicker fabrics, a larger needle can be replaced.

05

## Transfer pattern

Select the pattern you want to embroider, export it in DSB/DST format and store it on the computer, insert the USB into the computer, and transfer the pattern to the USB. Then insert the USB into the machine, click the USB icon on the pattern selection interface, and select the pattern you want.

For more information, please refer to the video "How to transfer pattern" in our USB.

06

## Pattern format recognition

Poolin EOC05 can only recognize DST/DSB format, and cannot directly recognize simple pictures. You need to go to special embroidery board software to make and export DST/DSB.

For more information, please refer to the video "How to convert images to DST/DSB format" in our USB.

07

## USB not recognized

Some USB formats are not compatible with the machine. You can try to replace a new USB or use the USB that comes with our machine.

08

## The spindle is out of position

Stop the machine, and turn the handwheel manually toward yourself, so that the mark on the handwheel coincides with the reference point on the fuselage.

For more information, please refer to the video "How to solve the spindle is out of position" in our USB.

09

## Thread tangled

You can use tools such as scissors to pull out the plugged thread. If there are too many plugged threads, it is necessary to disassemble the needle plate and clean the threads in it.

**Reason: too loose tension**

Solution: After cleaning the thread ball, adjust the tension to 3-4, and then Re-thread.

For more information, please refer to the video "How to solve thread tangled" in our USB.

10

## Skipping stitches

Re-thread the embroidery thread according to the manual and machine instructions, check whether the bobbin is installed correctly, reinstall the bobbin, and turn the bobbin thread counterclockwise.

For more information, please refer to the video "How to solve skipping stitches" in our USB.