

STEP 3

In order to prevent product tip over, please follow the instruction below to secure the unit to the wall.

Hardware List			Qty
 WALL PLUG	 EYELET SCREW	 CABLE TIE	1SET

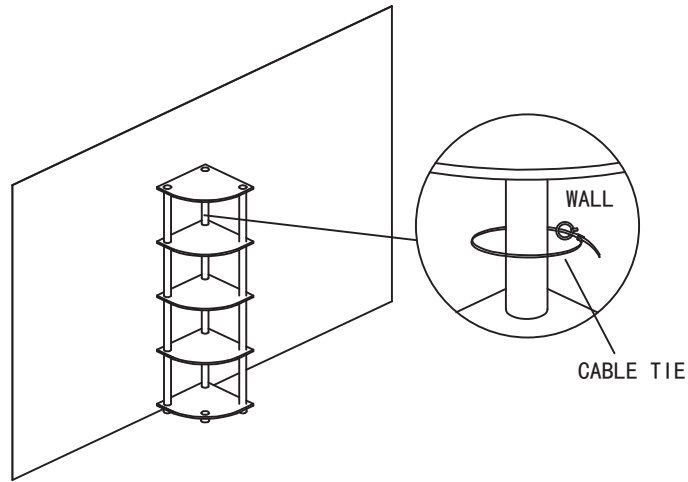
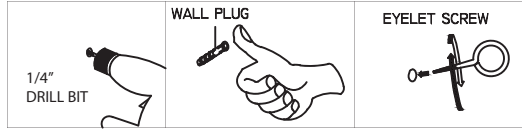

Recommended Maximum Weight

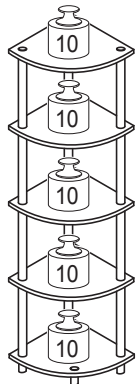

*Unit in Pound(lbs)

WARNING:

>This unit has been designed to support the maximum loads shown. Exceeding these load limits could cause sagging, instability, product collapse, and/or serious injury.



>DO NOT allow children to climb on unit.

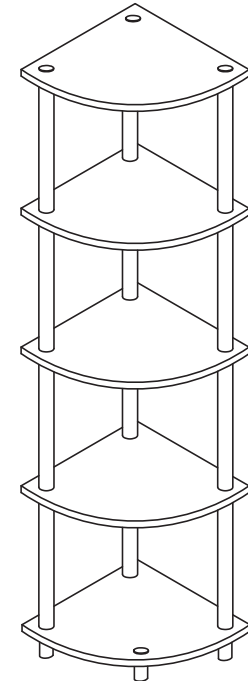
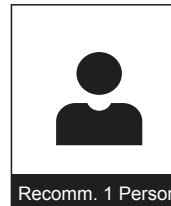
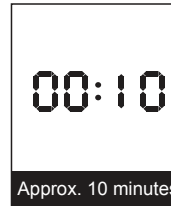

>Put heavier items on lower shelves.

Assembly Instruction

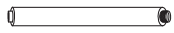
5 Tier Corner Display Rack Multipurpose
Shelving Unit



No	Hardware List	Qty
1	Long Pole 	12pcs
2	Top Cap 	4pcs
3	Round Leg 	4pcs

No	Parts List	Qty
A	Top / Shelf Panel 	4pcs
B	Bottom Panel 	1pc

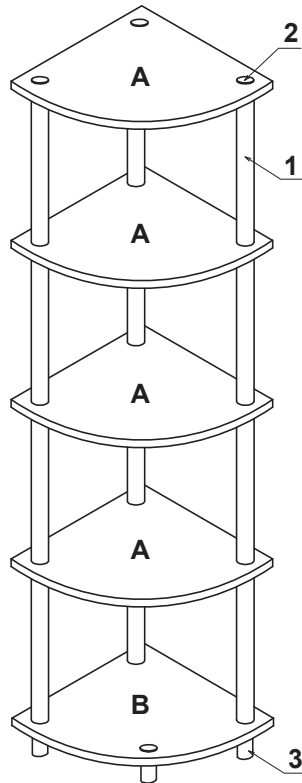





USEFUL HINTS BEFORE YOU START:

1. Read each step carefully before starting.
2. It is important that each step is performed in correct order to avoid difficulties.
3. Identify, sort and count the parts before assembly.
4. Assemble your furniture on packaging cardboard to prevent scratch or damage.
5. Clean the product with mild cleanser using soft damped cloth. Do not use harsh or abrasive cleanser.
6. Using incompatible hardware might cause damage to product.

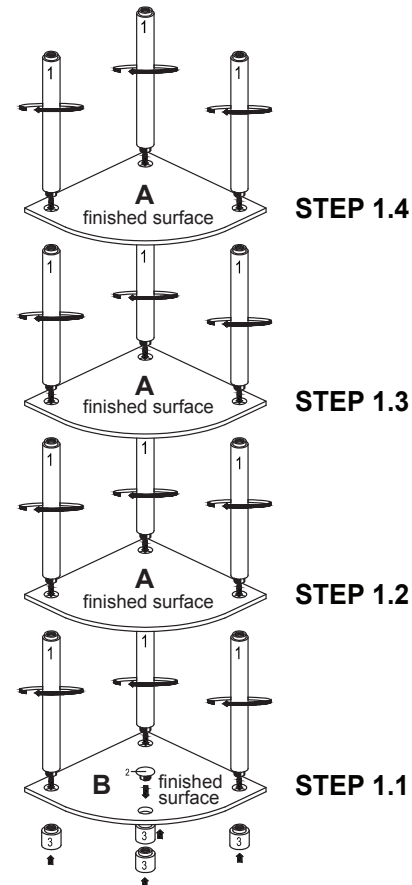
STEP 1

- 1.1 Attach Long Pole (1), Top Cap (2) and Round Leg (3) to Bottom Panel (B).
- 1.2 Attach Shelf Panel (A) and tighten Long Pole (1), as shown:



-  ① Long Pole - 12pcs
-  ② Top Cap - 1pc
-  ③ Round Leg - 4pcs

STEP 2

- Attach Top Panel (A) and tighten Top Cap (2), as shown:

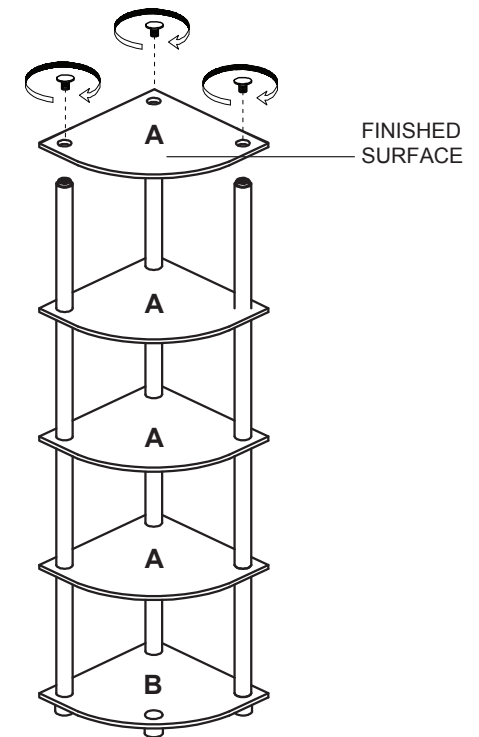

-  ② Top Cap - 3pcs