

DESCRIPTION

The Sure-Lites Emergency Light SEL series is a UL924 code compliant solution designed to run for a minimum of 90 minutes during a power outage. Key features of the series include: a nickel cadmium battery capable of providing up to 16 watts of remote capacity, polycarbonate housing and heads, long life and maintenance free LED source with proprietary accuLED optics, as well as self-diagnostics that perform NFPA required monthly testing. This series is fully compatible with SRP/SRM/SRPA LED remotes. The **patented** external battery disconnect and easy hang features reduce installation time and cost. The SEL series is designed for indoor commercial or industrial use.

Catalog #		Type
Project		
Comments		Date
Prepared by		

SPECIFICATION FEATURES

ELECTRICAL

- Universal voltage input 120V to 277V, 60Hz
- Provides 6V remote capacity of 10 watts - 16 watts (see remote system design guidelines)
- External battery disconnect
- Battery back-up
- Brownout circuit
- Low-Voltage disconnect
- Overload / Short circuit protection
- EZ Hang feature facilitates fast installation with keyhole mounting slots
- Self-diagnostics
- Laser test capability

HOUSING CONSTRUCTION

- Components are injection molded, color stable, high impact polycarbonate
- White or black textured finish
- Black only available for SEL60R10SD
- EZ Hang feature facilitates fast installation
- Keyhole mounting slots
- Suitable for ceiling, pendant, or wall mount applications
- Universal J-Box mounting pattern

BATTERY

- Sealed nickel cadmium
- Full recharge time 24 hours
- 0 °C to 40 °C (32 °F to 104 °F)

WARRANTY

- Five-year fixture warranty
- Prorated seven-year battery warranty

CODE COMPLIANCE

- UL924 Listed
- Damp location
- Life Safety NFPA 101
- NEC/OSHA
- Most State & Local Codes
- California Energy Code Compliant



SEL SERIES

Emergency Light w/Remote Capacity

- LED Emergency Light
- Adjustable Optics
- Self-Diagnostics
- Polycarbonate Housing

HOW TO SPECIFY

Sure-Lites LED emergency light with nickel cadmium battery, external battery disconnect, adjustable optics, polycarbonate housing, self-diagnostics, and up to 16 watts of remote capacity.

DIMENSIONS

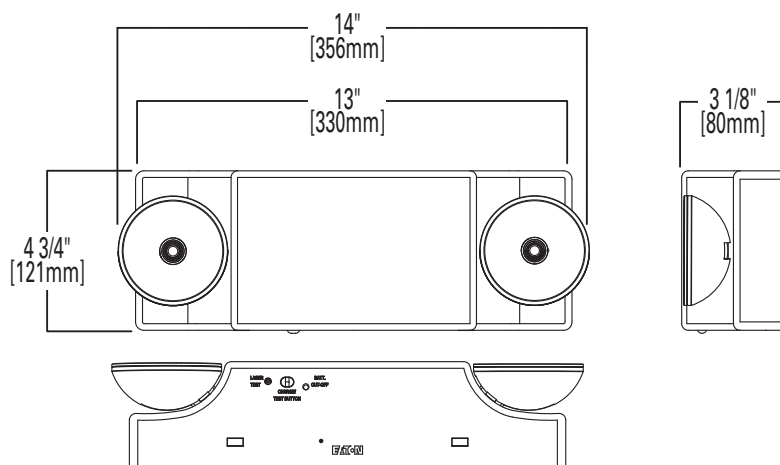

SEL60

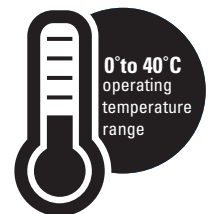
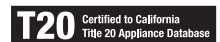
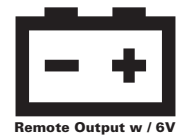

ENERGY DATA

	Input Power	Current
120V - 277V	5.1 W	0.8 A

ORDERING INFORMATION

SAMPLE NUMBER: SEL25R16SD

Series	Color	Spacing	Remote Capacity	Self Diagnostics
SEL = LED Emergency Light	_ = White	25 = 25 Feet	R16 = 16 Watts	SD = Self Diagnostics (Standard)

SAMPLE NUMBER: SEL50R14SD

Series	Housing	Spacing	Remote Capacity	Self Diagnostics
SEL = LED Emergency Light	_ = White	50 = 50 Feet	R14 = 14 Watts	SD = Self Diagnostics (Standard)

SAMPLE NUMBER: SEL60R10SD

Series	Housing	Spacing	Remote Capacity	Self Diagnostics
SEL = LED Emergency Light	_ = White	60 = 60 Feet	R10 = 10 Watts	SD = Self Diagnostics (Standard)

SAMPLE NUMBER: SEL60R10BKSD

Series	Housing	Spacing	Remote Capacity	Self Diagnostics
SEL = LED Emergency Light	BK = Black	60 = 60 Feet	R10 = 10 Watts	SD = Self Diagnostics (Standard)

TECHNICAL DATA

Remote Capacity

The SEL series offers 10 watts to 16 watts of remote capacity. This remote capacity can be used to power LED remotes with up to 193 feet of emergency coverage with 6V output voltage. The remotes are available in plastic (SRP series) and metal (SRM series) and are UL listed for wet location with a temperature rating from -30 °C to 60 °C. This additional capacity can also be used to extend the operation time of the 2 onboard heads.

Mechanical Housing

All components are injection molded with a color stable, high impact thermoplastic resin. The surface is textured to improve aesthetic appearance. The housing construction is designed with snap-fit components and reinforcement ribs to provide maximum strength at minimum installation effort. The mounting hole pattern is universal to junction box requirements and suitable for both wall and ceiling mount applications.

EZ Key External Power Disconnect

Prevents the battery from cycling during the construction phase and ensures battery is not drained from power cycling.

EZ Hang Mounting Feature

The hands-free EZ Hang feature allows the installer to hang the emergency light face from the back plate in order to easily and efficiently make the power connections.

Self Diagnostics

The self-diagnostic software automatically performs all tests required by UL924, and NFPA101. The software systematically calibrates itself in the field, reducing installation labor and eliminating manual calibration errors. The system indicates the status of the emergency light at all times using the LED indicator. A 90-minute battery power (emergency mode) simulation test occurs once every 12 months. A 30-second battery power simulation test occurs every 30 days. The solid-state microprocessor based system detects and warns of system failures, and incorporates all standard electronic features.

Low Voltage Disconnect

The low-voltage circuitry disconnects the lighting load to protect the battery during run times in excess of the 90-minute UL limit. The disconnect remains in effect until normal utility power is restored, preventing deep battery discharge.

Brownout Circuit

The brownout circuit on the SEL emergency light monitors the flow of AC current to the unit and activates the emergency light heads when a predetermined reduction of AC power occurs.

Laser Test

The laser test includes a laser pointer testing capability. Activation of the photocell test button with a laser pointer will simulate loss of AC power and engage the emergency operation of the exit and emergency heads.

Warranty

The SEL series is backed by a five-year warranty on the fixtures and a seven-year prorated battery warranty.



EZ Key

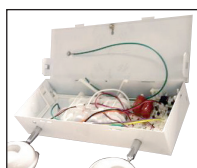

EZ Hang



Laser tester

Part Number = LASER
(sold separately)

REMOTE CAPACITY

SEL Series Remotes								
Watts Consumed		SRPA	Single Head Remotes				Double Head Remotes	
		SRPA29	SRP/SRM13	SRP/SRM25	SRP/SRM30	SRP25D/SRM25D	SRP50D/SRM50D	SRP60D/SRM60D
		3.5	1.25	2.5	4.1	2.5	5	8.2
Catalog number	Remote Watts Available	# of SRPA29 remotes fixture will power	# of SRP/SRM13 remotes fixture will power	# of SRP/SRM25 remotes fixture will power	# of SRP/SRM30 remotes fixture will power	# of SRP25D/SRM25D remotes fixture will power	# of SRP50D/SRM50D remotes fixture will power	# of SRP60D/SRM60D remotes fixture will power
SEL25R16SD	16	4	12	6	3	6	3	1
SEL50R14SD	14	4	11	5	3	5	2	1
SEL60R10SD	10	2	8	4	2	4	2	1
SEL60R10BKSD	10	2	8	4	2	4	2	1



SRP



SRPD



SRM



SRMD



SRPA WHITE



SRPA BLACK

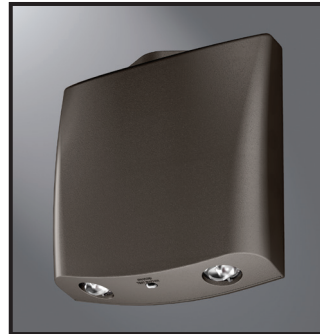

SRPA BRONZE

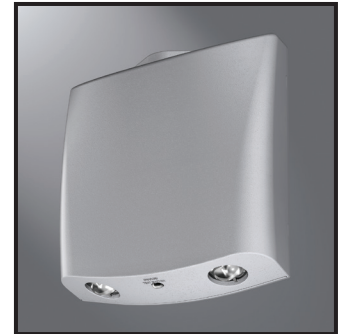

SRPA SILVER

PHOTOMETRY

SEL25

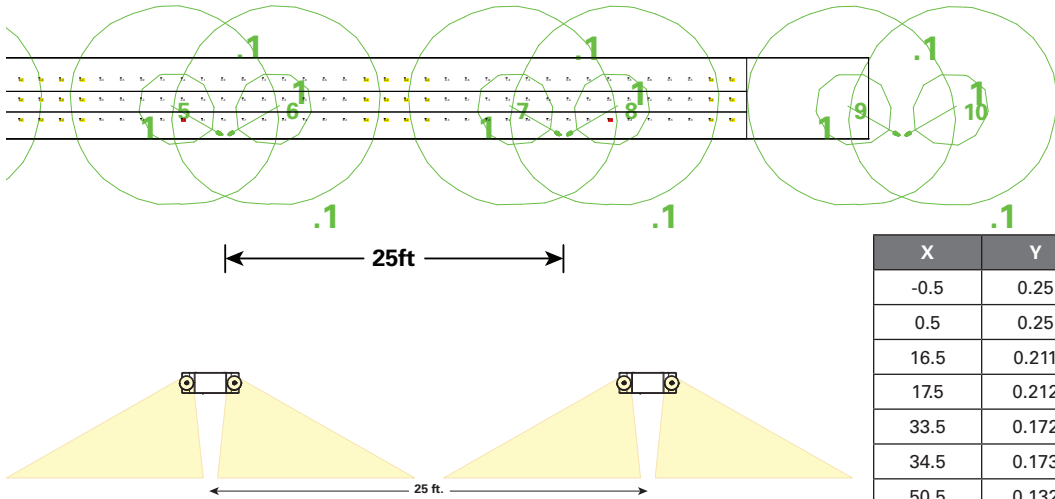

X	Y	Z	Orient	Tilt
-0.5	0.25	7.5	125	27
0.5	0.25	7.5	55	27
16.5	0.211	7.5	125	27
17.5	0.212	7.5	55	27
33.5	0.172	7.5	125	27
34.5	0.173	7.5	55	27
50.5	0.132	7.5	125	27
51.5	0.135	7.5	55	27
67.5	0.093	7.5	125	27
68.5	0.096	7.5	55	27
84.5	0.054	7.5	125	27
85.5	0.058	7.5	55	27
101.5	0.015	7.5	125	27
102.5	0.019	7.5	55	27

***The "Rule of Thumb" spacing guidelines are designed to achieve 1 foot-candle average and 0.1 foot-candle minimum with a 40:1 maximum/minimum ratio. The corridor used is 100 feet long, 9 foot ceiling with a 6 foot wide walkway and 3 foot path of egress. The reflectances are 80% ceiling, 50% walls and 20% floors. The fixture mounting height is 7.5 feet. Eaton assumes no responsibility for local requirements or specific project variables. This guideline is used as a design aid, not as a guarantee of any code compliance.

SEL50

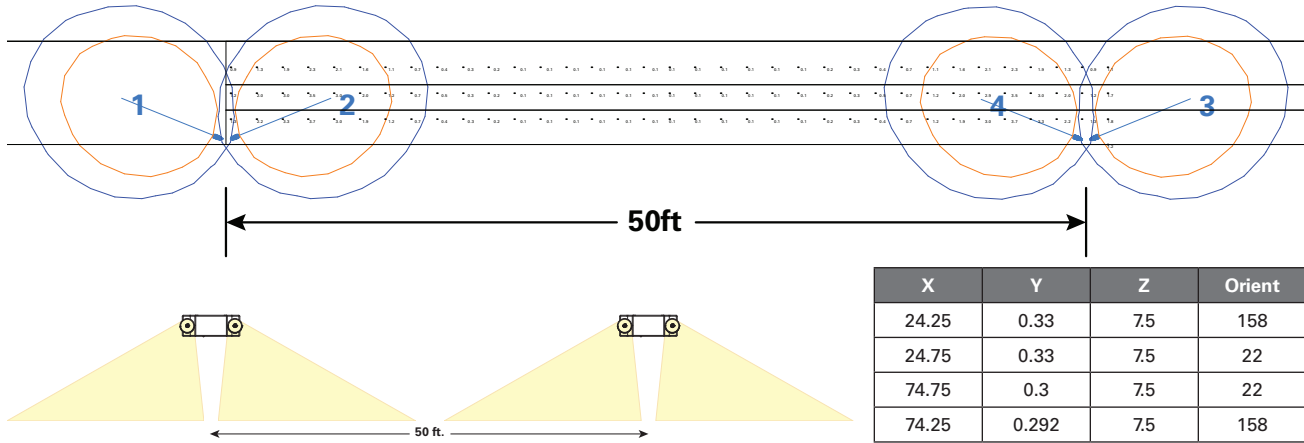

X	Y	Z	Orient	Tilt
24.25	0.33	7.5	158	40
24.75	0.33	7.5	22	40
74.75	0.3	7.5	22	40
74.25	0.292	7.5	158	40

SEL60

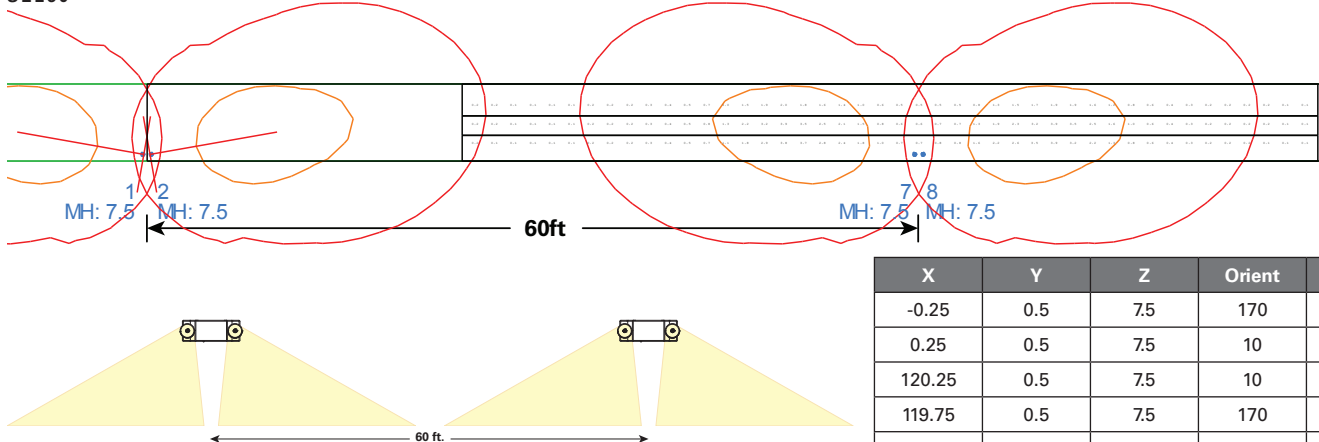

X	Y	Z	Orient	Tilt
-0.25	0.5	7.5	170	57
0.25	0.5	7.5	10	57
120.25	0.5	7.5	10	57
119.75	0.5	7.5	170	57
59.75	0.5	7.5	170	57
60.25	0.5	7.5	10	57
180.25	0.5	7.5	10	57
179.75	0.5	7.5	170	57

SELF-DIAGNOSTIC TESTING OPERATIONS

The Sure-Lites self-diagnostics is continuously monitoring your emergency fixture, and will signal any failure through the 3 color indicator LED.

Initial Operation:

When the unit is first powered up it will go into a 24-hour fast charge and the indicator LED will pulse green. Once the unit has fully charged it will perform a self calibration. After self calibration, the LED will change to steady green indicating the unit is fully charged and float charging the battery to maintain readiness.

Automatic Testing:

The unit will perform a battery capacity, lamp/LED, and charge circuit test every 30 days for 30-seconds. During this time, the indicator LED will change to a steady yellow. It will perform a full battery capacity (90-minute) test once per year. During this time, the indicator LED will change to a blinking yellow.

Manual Testing:

- 10-Second Installation Test – Press and release the test button once during fast charge (blinking green) to initiate a 10-second quick test. The sign will switch to emergency mode for 10-seconds allowing the installer to verify proper installation of the unit, and the LED indicator will turn solid yellow
- 30-Second Test – Press and release the test button once during float charge (steady green). The indicator LED will turn steady yellow to indicate the unit is performing a 30-second test of the batteries and lamps/LEDs
- 90-Minute Test – Press and release the test button a second time during a 30-second test (steady yellow) to change to a 90-minute test. During this test, the LED indicator will change to blinking yellow, and the circuit will perform a full battery capacity, charge circuit, and LED test
- Canceling Test – Press and release the test button during the 90-minute test (flashing yellow) to return the fixture to its original state (fast charge or float charge)

Laser Test:

The SEL SD products are equipped with a Laser Test function that allows the unit to be manually tested without the need to physically press the test button. Shining a laser pointer in the hole marked "LASER TEST" on the bottom of the unit has the same effect as a press and release of the test button.

Clearing Failure Codes:









- A battery failure (LED two blink red) can be cleared by replacing the battery. Disconnecting the battery and AC power, or performing a full 90-minute discharge will reset the error code, however, it will return if the battery is faulty
- Charge Circuit (LED three blink red) and lamp/LED failure (LED four blink red) will clear when the unit successfully passes a manual or automatic 30-second test

Indicators:

- LED Off - No power to unit, emergency mode
- LED Steady Green - Unit is fully charged and is float charging the battery to maintain readiness
- LED Green Pulse - Unit is in a 24-hour fast charge of the battery
- LED Two Blink Red - Battery has failed a capacity test, or the battery is disconnected. See "Clearing Failure Codes" above
- LED Three Blink Red - Battery charge circuit has failed. See "Clearing Failure Codes" above
- LED Four Blink Red - Lamps have burned out, or on an EXIT/Combo, 50% or more of the LEDs have failed. See "Clearing Failure Codes" above
- LED Steady Yellow - 30-second test or 10-second quick test (Fast Charge only)
- LED Blinking Yellow - 90-minute test

Maintenance:

None required. Replace the batteries as needed according to ambient conditions. However, we recommend that the equipment be tested regularly in accordance with local codes.

SURE-LITES SELF DIAGNOSTICS EATON		OFF - EMERGENCY MODE / POWER OFF		STEADY BLINK YELLOW - 90 MINUTE TEST
		STEADY BLINK GREEN - FAST CHARGE		2 BLINK RED - BATTERY FAILURE
		STEADY GREEN - FULL / FLOAT CHARGE		3 BLINK RED - CHARGE CIRCUIT FAILURE
		STEADY YELLOW - QUICK TEST		4 BLINK RED - LAMP / LED FAILURE