

Instruction Manual

130cm Folding Bench

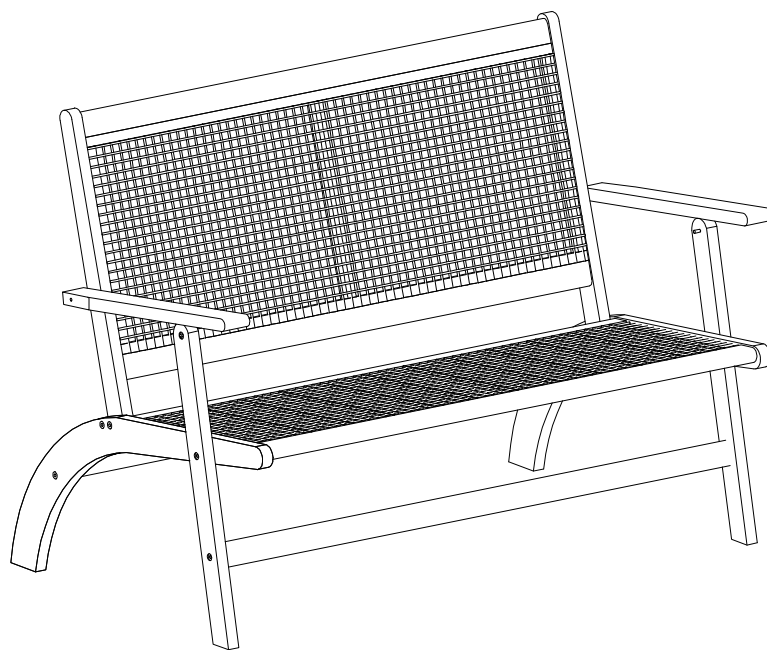

CONTENTS

Safety and care advice	1
Components	2
Assembly instructions	4
Copyright	8

⚠ SAFETY AND CARE ADVICE ⚠

PLEASE READ THESE INSTRUCTIONS CAREFULLY AND KEEP FOR FUTURE REFERENCE

- **Warning:** Please lift with care.
- Check you have all the components and tools listed on pages 2 and 3.
- Remove all fittings from the plastic bags and separate them into their groups.
- Keep children and animals away from the work area, small parts could choke if swallowed.
- Make sure you have enough space to lay out the parts before starting.
- Do not stand or put weight on the product, this could cause damage.
- Assemble the item as close to its final position (in the same room) as possible.

- Assemble on a soft level surface to avoid damaging the unit or your floor (use opened out unit carton).



- We do not recommend the use of power drill/drivers **for inserting screws**, as this could damage the unit. Only use hand screwdrivers.
- Dispose of all packaging carefully and responsibly.

CARE AND MAINTENANCE

- Only clean using a damp cloth and mild detergent, do not use bleach or abrasive cleaners.
- From time to time check that there are no loose screws on this unit.

- This product should not be discarded with household waste. Take to your local authority waste disposal center.

Note *If required the next page can be cut out and used as reference throughout the assembly. Keep this page with these instructions for future reference.*

COMPONENTS

Please check you have all the panels listed below:

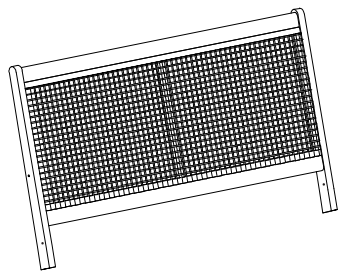
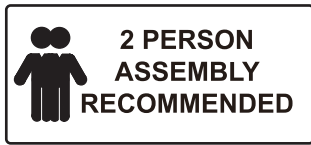

① X1

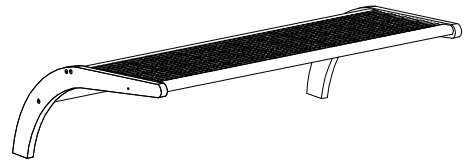

② X1

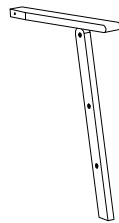

③ X1

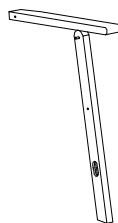

④ X1

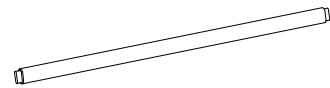

⑤ X1

1. Backrest	x 1	4. Leg 2	x 1
2. Seat	x 1	5. Stretcher	x 1
3. Leg 1	x 1		



COMPONENTS

Please check you have all the fittings listed below:

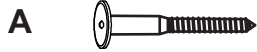

Screw ($\Phi 7 \times 60 \text{mm}$) x 2

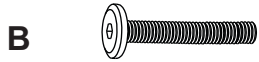

Bolt ($\Phi 8 \times 70 \text{mm}$) x 2

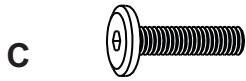

Bolt ($\Phi 8 \times 45 \text{mm}$) x 2



Bolt ($\Phi 6 \times 20 \text{mm}$) x 6



Nut ($\Phi 6 \times 13 \text{mm}$) x 6



Washer ($\Phi 10 \times 20 \times 1 \text{mm}$) x 2



Washer ($\Phi 8 \times 18 \times 2 \text{mm}$) x 4

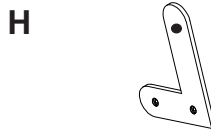

Stretchers Connection x1



Stretchers Connection x1

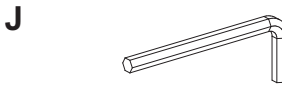





Allen key x 2



ASSEMBLY INSTRUCTIONS

Step 1

D		6
E		6
F		2
J		2

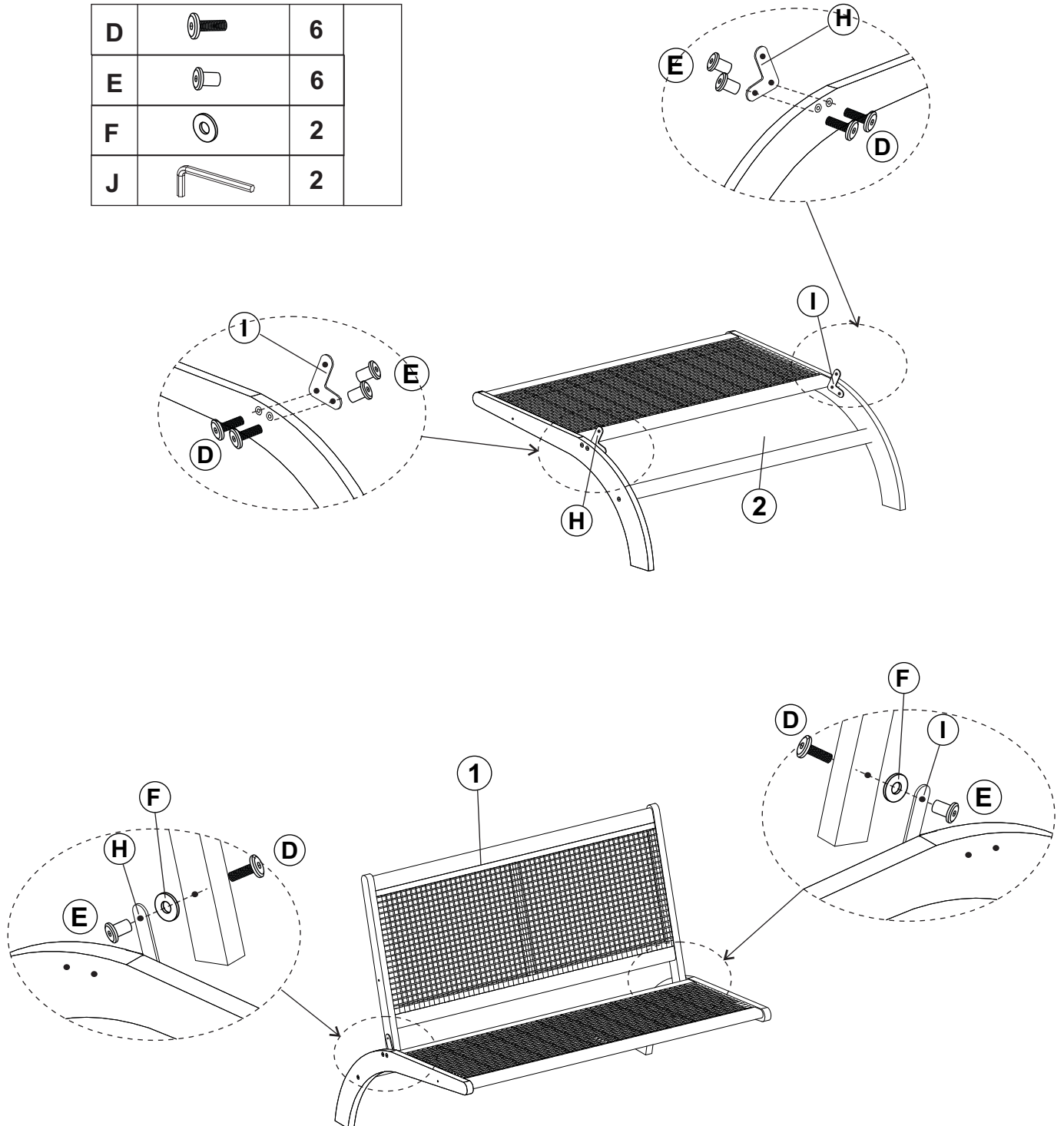

ASSEMBLY INSTRUCTIONS

Step 2

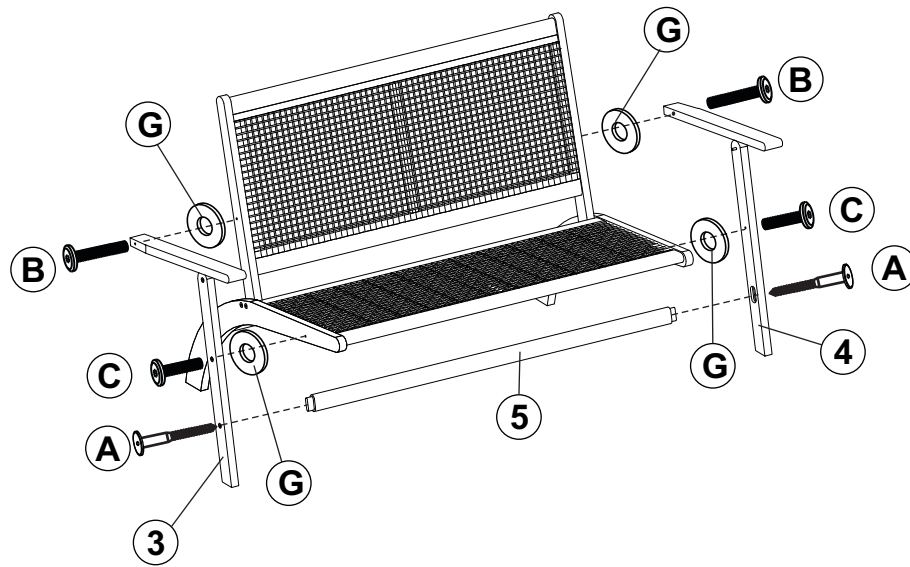

Step 3

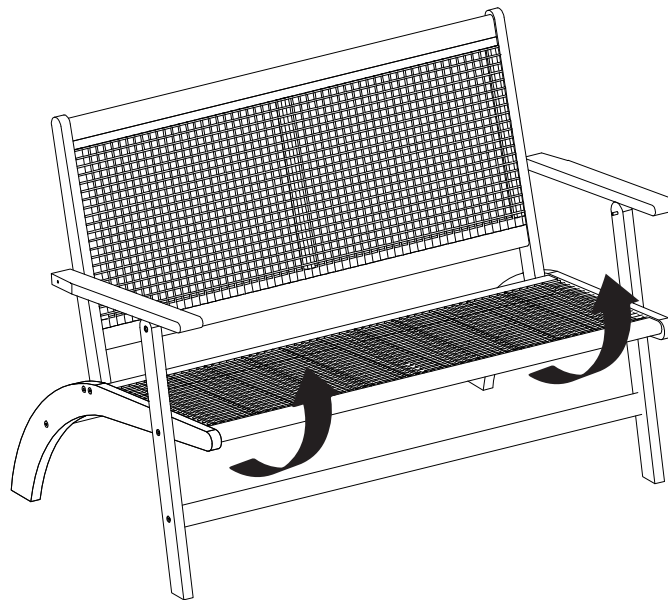

Congratulations! Now you have finished assembling the product.

ASSEMBLY INSTRUCTIONS

Step 4

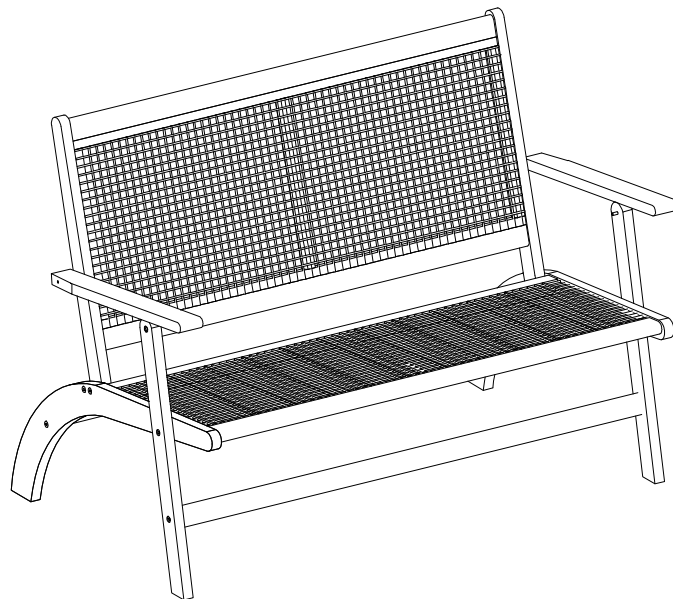
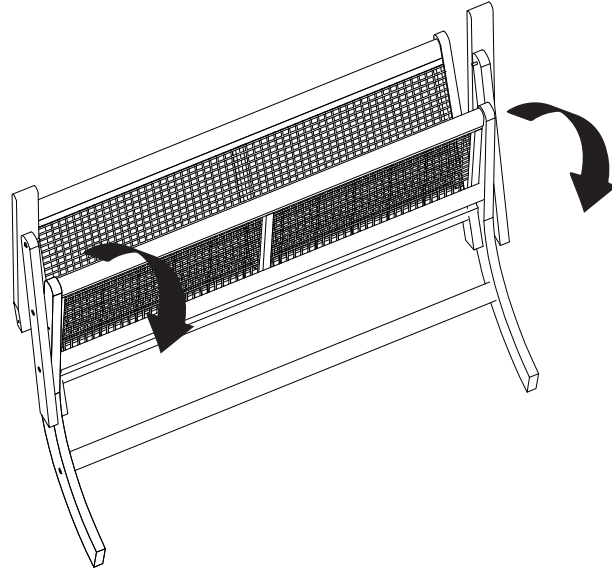

IF YOU FIND A DEFECTIVE PART

We fully stock all parts and components. Any defective part can be quickly replaced. Take note of the defective part number in manual and we will arrange a quick replacement.

COPYRIGHT

All material in this instruction manual is copyrighted
Any unauthorised use may violate worldwide copyright, trademark and other laws.