

Top View

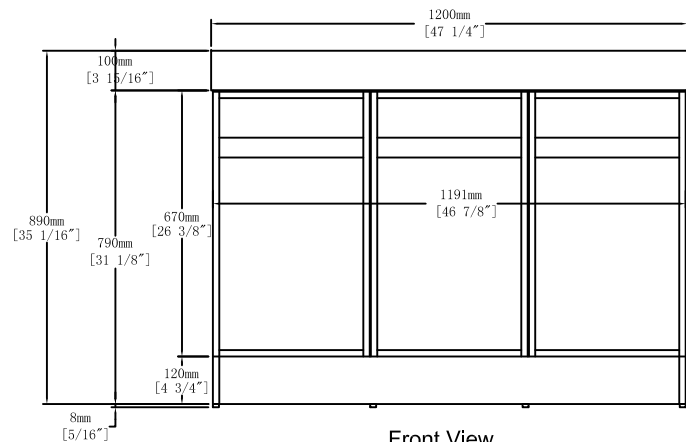

Front View

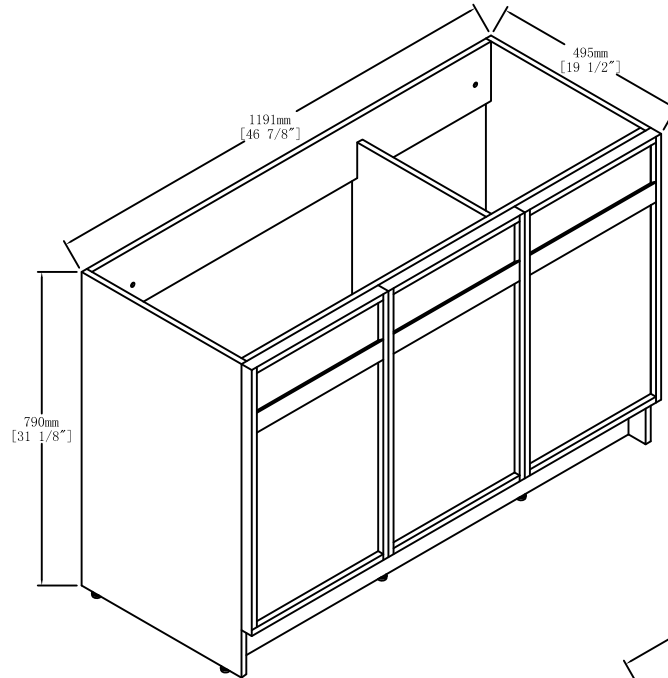
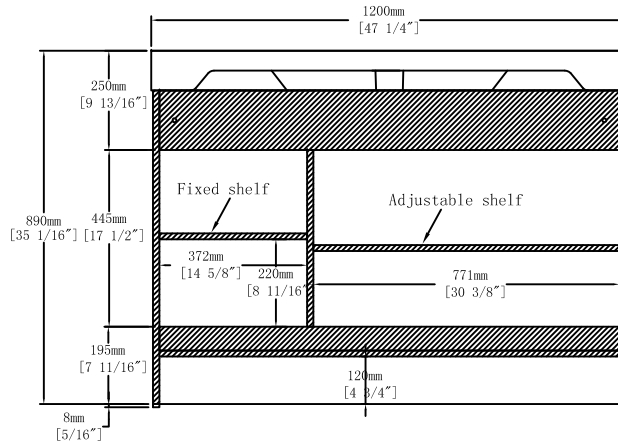

Back View

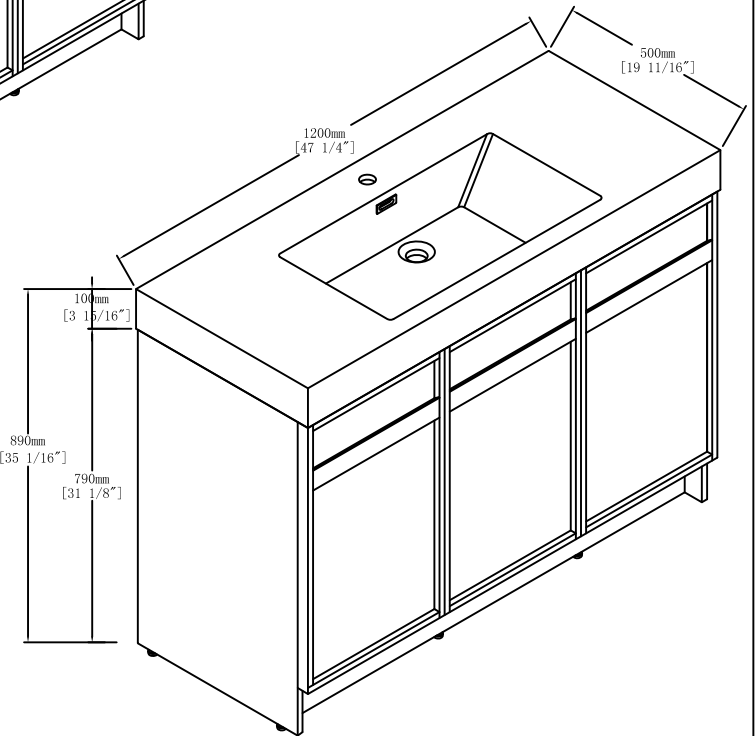

Item NO.

BV C11148

Version

V1

Project

Date

2024-10-1