



Assembly Instructions

Caution : You must read this before you proceed





Dining Chair

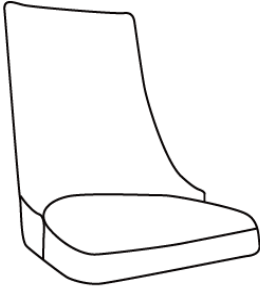

Parts List

Label	Picture	Description	QTY
A		Hind Leg	2
B		Front Leg	2
C		Chair Body	1

Hardware

Label	Picture	Description	QTY
①		Allen Key	1
②		Bolt (M6*16mm)	15
③		Washer (12mm)	15
④		Spring Washer (12mm)	15

Assembly Preparation

Before Beginning Assembly:

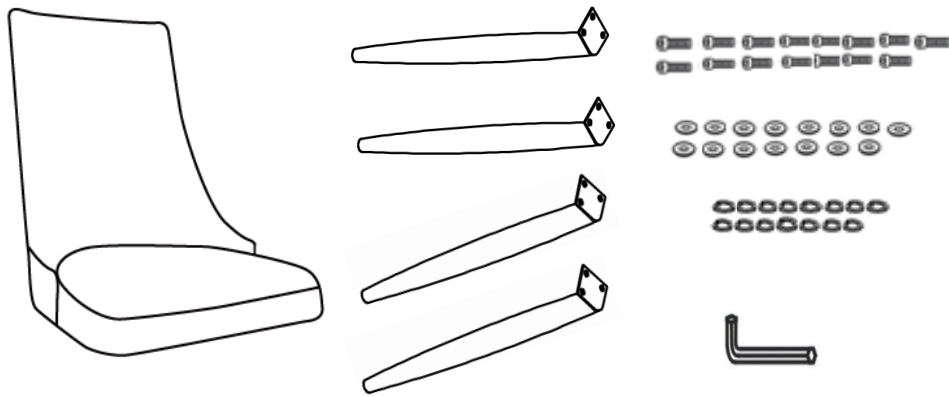

- Read instructions, cover to cover-



- Have 2 adults on hand for assembly-



- Do not assemble on flooring or carpet-



- Assemble on a clean non-marring surface (packing foam)-



- Save all packaging until finished-

Assembly Steps

Overview

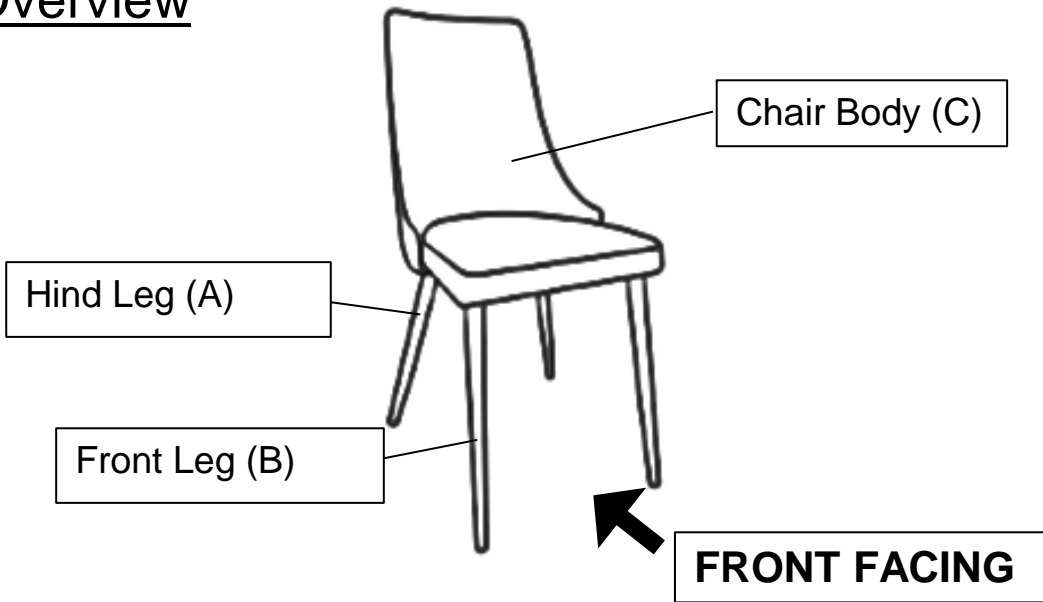

This Dining Chair has multiple parts and may require up to 30 minutes to assemble. To give you an overview of the Dining Chair parts, the above picture is to help you put the various parts into perspective. Please read through the instructions below to familiarise yourself with the parts and steps before assembly.

Step 1

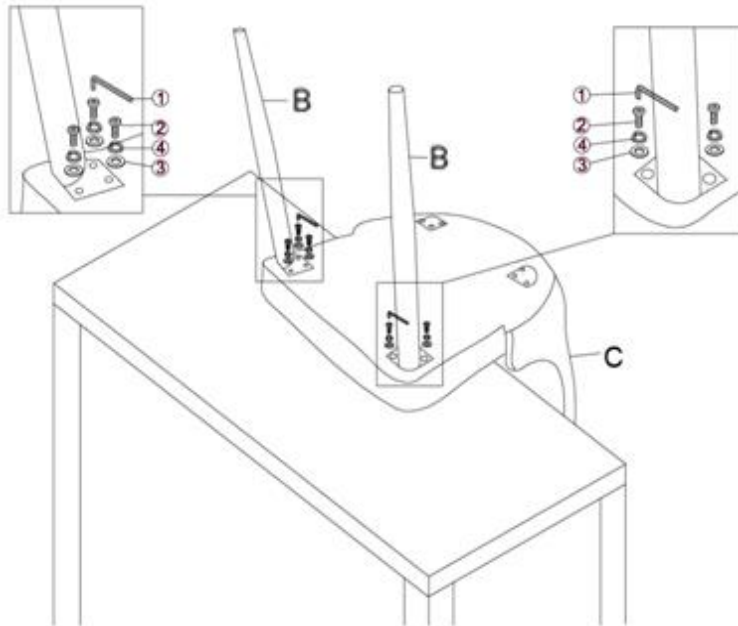

Place the Chair Seat(C) upside down on the edge of a clean Table Top.
Attach Front Leg(B) to Chair Seat(C) using 3pcs each Bolts(②), Washers(③), and Spring Washers(④), with Allen Key(①) as pictured above.
Repeat this same process to attach the other Front Leg(B) to Chair Seat(C).
Do not fully tighten the Bolts.

Step 2

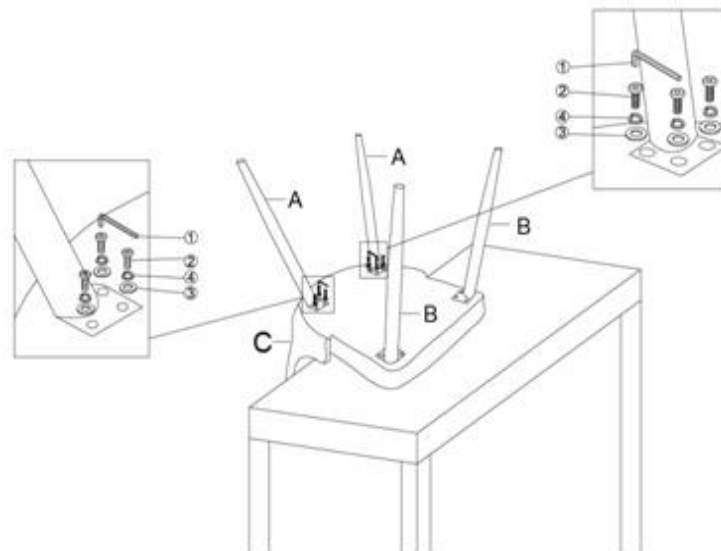

Attach Hind Leg(A) to Chair Seat(C) using Bolts(②), Washers(③), and Spring Washers(④), with Allen Key(①) as pictured above.

Repeat this same process to attach the another Hind Leg(A) to Chair Seat(C).

Do not fully tighten the Bolts.

Step 3



Stand the Chair up and place on flat, level surface.

Carefully and gently sit onto the Chair.

This will help properly align all parts at all joints and remove any gaps.

Carefully get off the Chair and gently turn it over.

Then proceed to tighten all Bolts at all joints.

When tightening the Bolts, tighten sequentially.





















Do not tighten any Bolt fully and then move on towards the next one, this could cause the frame to warp.

If the Chair is not Stable it could lead to damage to the product.

Your Dining Chair is ready for use.

This Dining Chair can only be used on a flat, level surface.

Care & Maintenance

-   • Do not put hot items directly on furniture surface
 -   • Do not clean furniture with harsh cleansers or polish.
 -   • Do not place furniture under direct sunlight.
 -   • Do not place furniture near heating or cooling vents.
 -   • Do not write on furniture without a padded barrier to protect the surface.
 -   • Do not place furniture outside . For indoor use only .
 -   • Not for commercial use. For residential use only .
 -   • Stains may be removed with mild soap solution and damp cloth.
 -   • Children should not climb or jump on the furniture.
-
-   • Dust and pick-up spills using a clean, non-colored, lint-free cloth .

Questions & Answers about Proposition 65

• What is Proposition 65?

Proposition 65 requires businesses to provide warnings to Californians about significant exposures to chemicals that cause cancer, birth defects or other reproductive harm. These chemicals can be in the products that Californians purchase, in their homes or workplaces, or that are released into the environment. By requiring that this information be provided, Proposition 65 enables Californians to make informed decisions about their exposures to these chemicals.

Proposition 65 also prohibits California businesses from knowingly discharging significant amounts of listed chemicals into sources of drinking water.

Proposition 65 requires California to publish a list of chemicals known to cause cancer, birth defects or other reproductive harm. This list, which must be updated at least once a year, has grown to include approximately 900 chemicals since it was first published in 1987.

• What types of chemicals are on the Proposition 65 list?

The list contains a wide range of naturally occurring and synthetic chemicals that include additives or ingredients in pesticides, common household products, food, drugs, dyes, or solvents. Listed chemicals may also be used in manufacturing and construction, or they may be byproducts of chemical processes, such as motor vehicle exhaust.

• What does a warning mean?

If a warning is placed on a product label or posted or distributed at a workplace, a business, or in rental housing, the business issuing the warning is aware or believes that it is exposing individuals to one or more listed chemicals.

By law, a warning must be given for listed chemicals unless the exposure is low enough to pose no significant risk of cancer or is significantly below levels observed to cause birth defects or other reproductive harm.

• Where can I get more information on Proposition 65?

If you have specific questions on the administration or implementation of Proposition 65, you can contact OEHHA's Proposition 65 program at P65.Questions@oehha.ca.gov, or by phone at (916) 445-6900.