

Top View

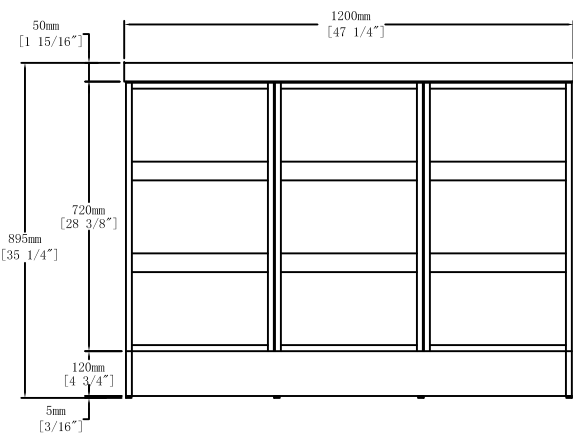

Front View

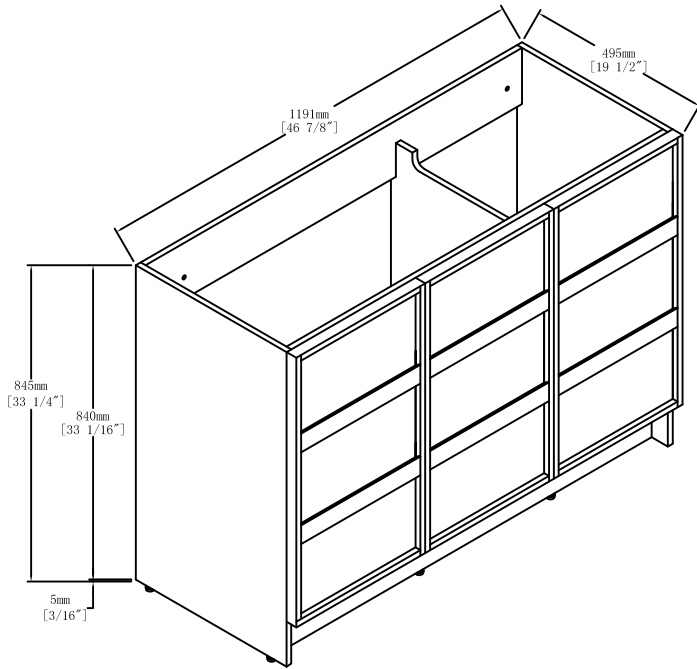
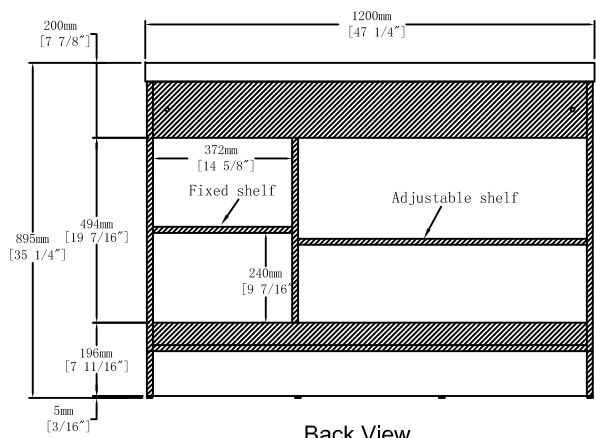

Back View

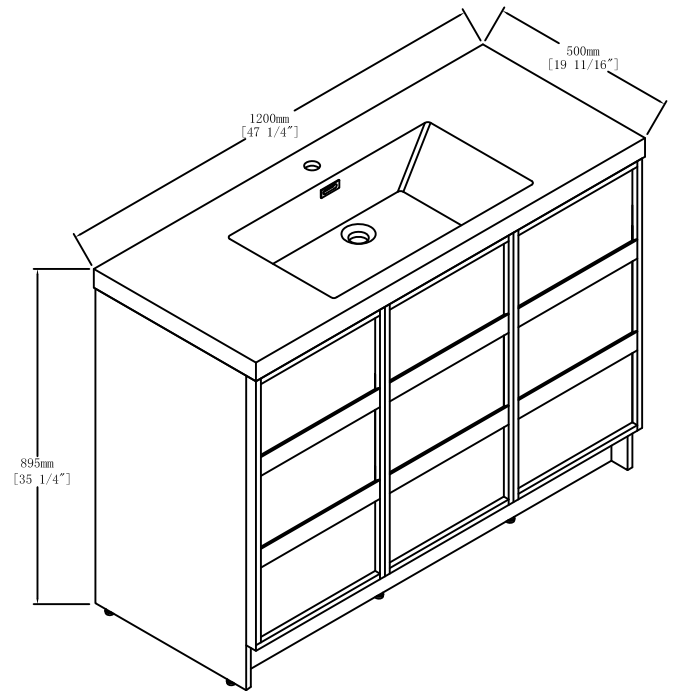

Item NO.	BV B12848	Version	V1
Project		Date	2025-7-2