

# SPORTSROYALS

YT-A03

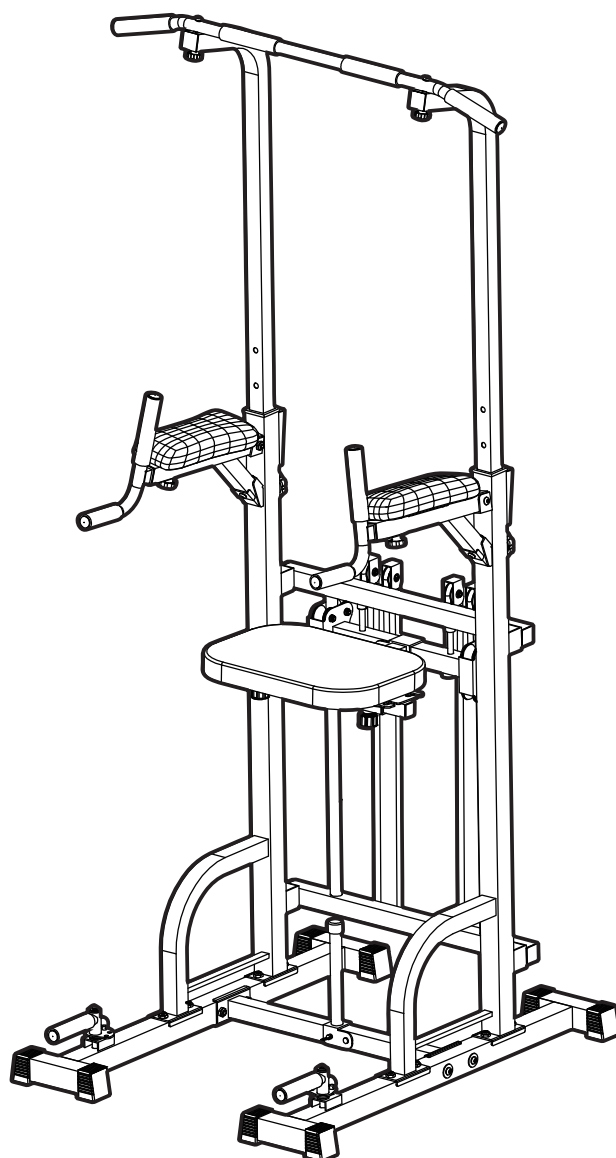

## Power Tower



**IMPORTANT!**

Please read this manual before assembling and using. Retain this user manual for using instructions. Your satisfaction is very important to us, any questions.

PLEASE CONTACT US: [support@sportsroyals.com](mailto:support@sportsroyals.com)

 **Email Address:**

**support@sportsroyals.com**

## Content

Customer Service .....	01
Safety Instructions .....	01
Parts List .....	02
Hardware Pack .....	04
Assembly Instructions .....	05
Warranty .....	13

# Customer Service

Please let us know if you have any issues or concerns with the transaction, shipping or product. And relevant photos or video are very important to help us better understand the problem. We'll do our best to make it right for you!



✉ Email Address: [support@sportsroyals.com](mailto:support@sportsroyals.com)

## Safety Instructions

**To ensure your safety and avoid accidents, please read the manual carefully before use and pay attention to the following safety matters.**



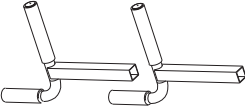
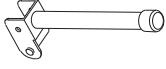
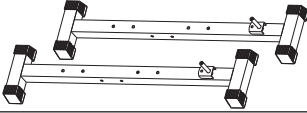
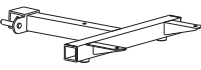
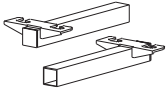
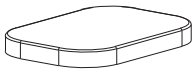
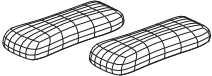
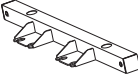
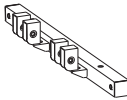
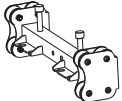
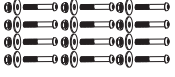
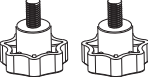
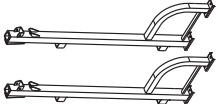

















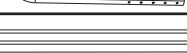

- Before starting any exercise you should consult your physician to determine if you have any medical or physical conditions.
- Ensure that all nuts and bolts are securely tightened before workout.
- Keep the children, the elderly and pets away from the equipment.
- Please do not let your child touch the moving parts to avoid injury. The machine contains small parts that may cause suffocation. Please do not remove the parts.
- Always use the equipment as indicated, if there something wrong with this product, stop using the equipment immediately.
- The equipment is not suitable for therapeutic use.
- Wear comfortable, good quality walking and running shoes and appropriate clothing when use the equipment.
- You must take care of ourselves when moving and adjusting the equipment so as not to injure your body.
- Use this product on a solid, flat level surface with a protective cover for your floor or carpet.
- This equipment is designed for indoor and home use only, it is not intended for commercial use.
- If you find any problem with our product, please contact us freely.

# Parts List

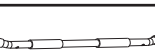
No.	Accessory Drawing	Part Name	QTY.
1		Arm Handle	2
2		Anti-crash Frame	1
3		Base Bracket	2
4		Middle Cushion Shelf	1
5		Cushion Telescopic Shelf(L/R)	2
6		Middle Cushion	1
7		Armrest Pad	2
8		Vertical Tube Crossbar	1
9		Stretch Wheel Frame	1
10		Pulley Wheel Frame	1
11		M10*65 Bolt + 10*30 Flat Washer + M10 Nut	12
12		M8 Knob	2
13		Vertical Tube(L/R)	2
14		M8*12 Screw + Spring Washer + Flat Washer	2
15		M8*16 Flat Washer	4

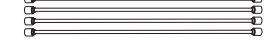
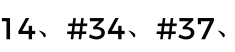

(Please note: #14、#34、#37、#38 screw are pre-installed on the product)

# Parts List

No.	Accessory Drawing	Part Name	QTY.
16		M8 Nut	4
17		M10*55 Bolt + M10 Nut	2
18		M10*70 Screw	2
19		M10 Knob	2
20		M8*30 Screw	4
21		M10*45 Screw	2
22		M8*50 Screw	5
23		M16 Knob	2
24		Open-end Wrench	2
25		M8*68 Latch	3
26		Rollers	4
27		M10*80 Latch	1
28		Push-up Handle (L/R)	2
29		Allen Wrench	2
30		Telescopic Tube	2
31		Cord 1	4
32		Base Crossbar	1
33		Pull-up Bar	1
34		M8*16 Screw	2
35		M10*65 Knob	2
36		Arm Handle Shelf (L/R)	2
37		M6*16 Screw	8
38		M12*16 Screw	4
39		Composite Tube	2
40		Cord 2	4

(Please note: #14、#34、#37、#38 screw are pre-installed on the product)

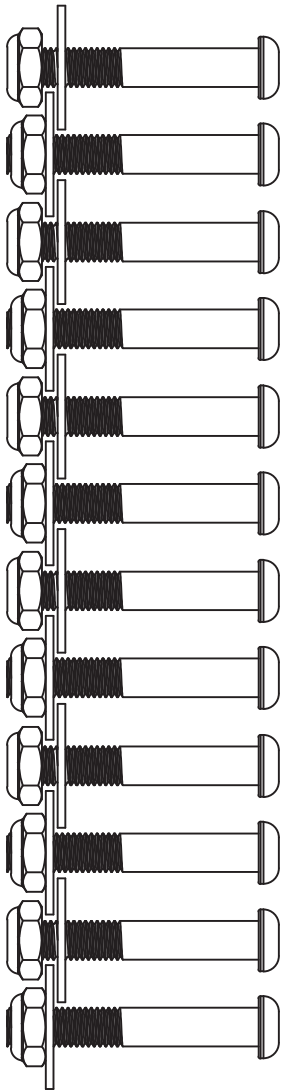
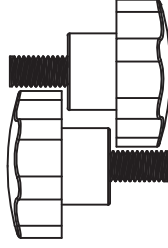
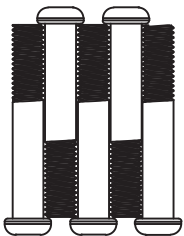
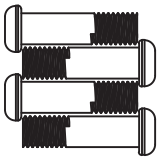
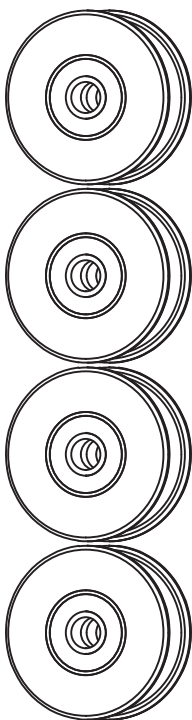
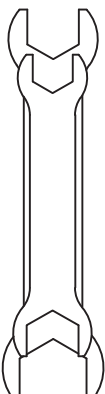
# Hardware Pack

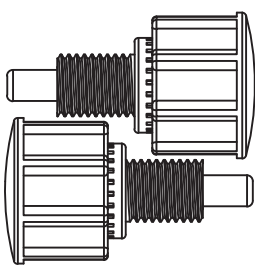
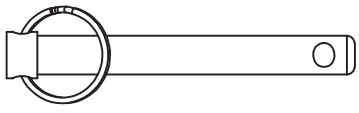
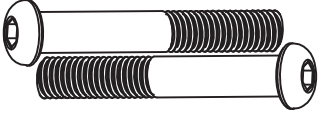
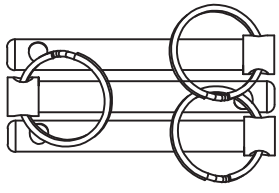
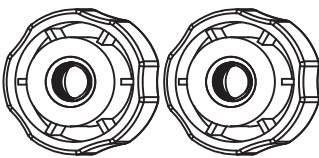
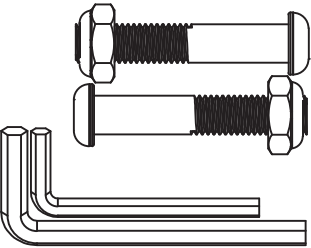
<p><b>STEP 1</b></p>  <p>(#11) M10*65 Bolt + 10*30 Flat Washer + M10 Nut-12pcs</p>	<p><b>STEP 2</b></p>  <p>(#12) M8 Knob-2pcs</p>				
<p><b>STEP 4-1</b></p>  <p>(#22) M8*50 Screw-5pcs</p>	<p><b>STEP 4-2</b></p>  <p>(#20) M8*30 Screw -4pcs</p>	<p><b>STEP 4-2</b></p>  <p>(#26) Rollers-4pcs</p>			
<p><b>STEP 2</b></p>  <p>Open-end Wrench</p>	<p><b>STEP 4-1</b></p>  <p>(#15) M8*16 Flat Washer -4pcs</p>	<p><b>STEP 4-2</b></p>  <p>(#16) M8 Nut-4pcs</p>			
<p><b>STEP 5</b></p>  <p>(#23) M16 Knob-2pcs</p>	<p><b>STEP 5</b></p>  <p>(#27) M10*80 Latch</p>	<p><b>STEP 3</b></p>  <p>(#18) M10*70 Screw-2pcs</p>	<p><b>STEP 6</b></p>  <p>(#25) M8*68 Latch-3pcs</p>	<p><b>STEP 3</b></p>  <p>(#19) M10 Knob-2pcs</p>	<p><b>STEP 2</b></p>  <p>Allen Wrench (#17) M10*55 Bolt + M10 Nut-2pcs</p>

# Assembly Instructions



## Step 1

- Install the base brackets and vertical tubes. Connect the base brackets to the vertical tubes using M10\*65 bolts + 10\*30 flat washers + M10 nuts (#11).  
Note: Distinguish between the left and right vertical tubes.
- Install the base crossbar. Use M10\*65 bolts + 10\*30 flat washers + M10 nuts (#11) to connect the two base brackets to the base crossbar. Ensure the main frame is stable before tightening the bolts.

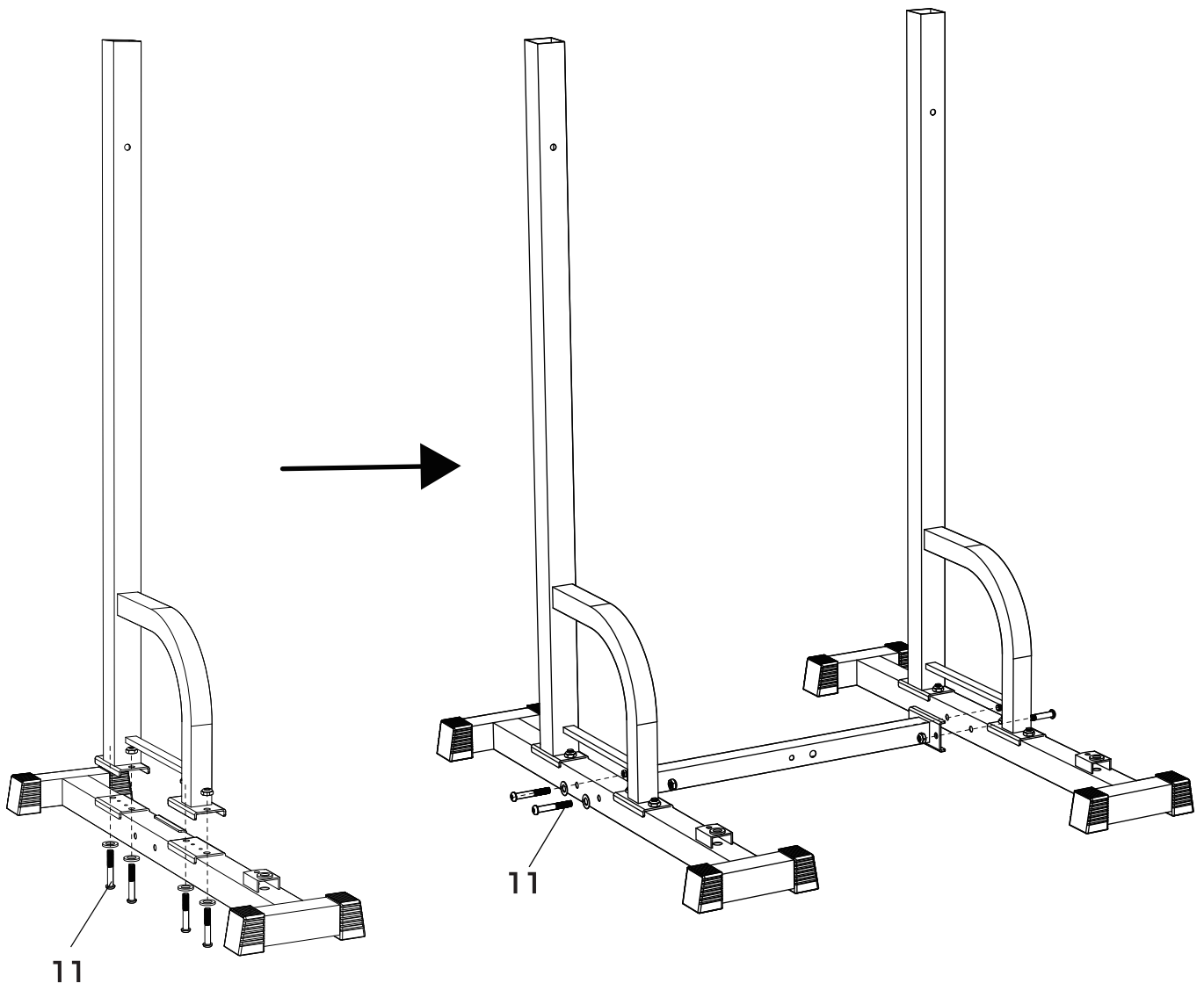

# Assembly Instructions



## Step 2

- First secure the armrest pad to the arm handle shelf using the M6\*16 screw (#37). The screw (#37) is pre-installed on the armrest pad and must be removed first.
- Insert the arm handle shelf into the vertical tube. Secure the top with an M10\*55 bolt + M10 nut (#17) and the bottom with an M10\*45 screw (#21).
- Insert the arm handle into the arm handle shelf and tighten it from below using the M8 knob (#12).

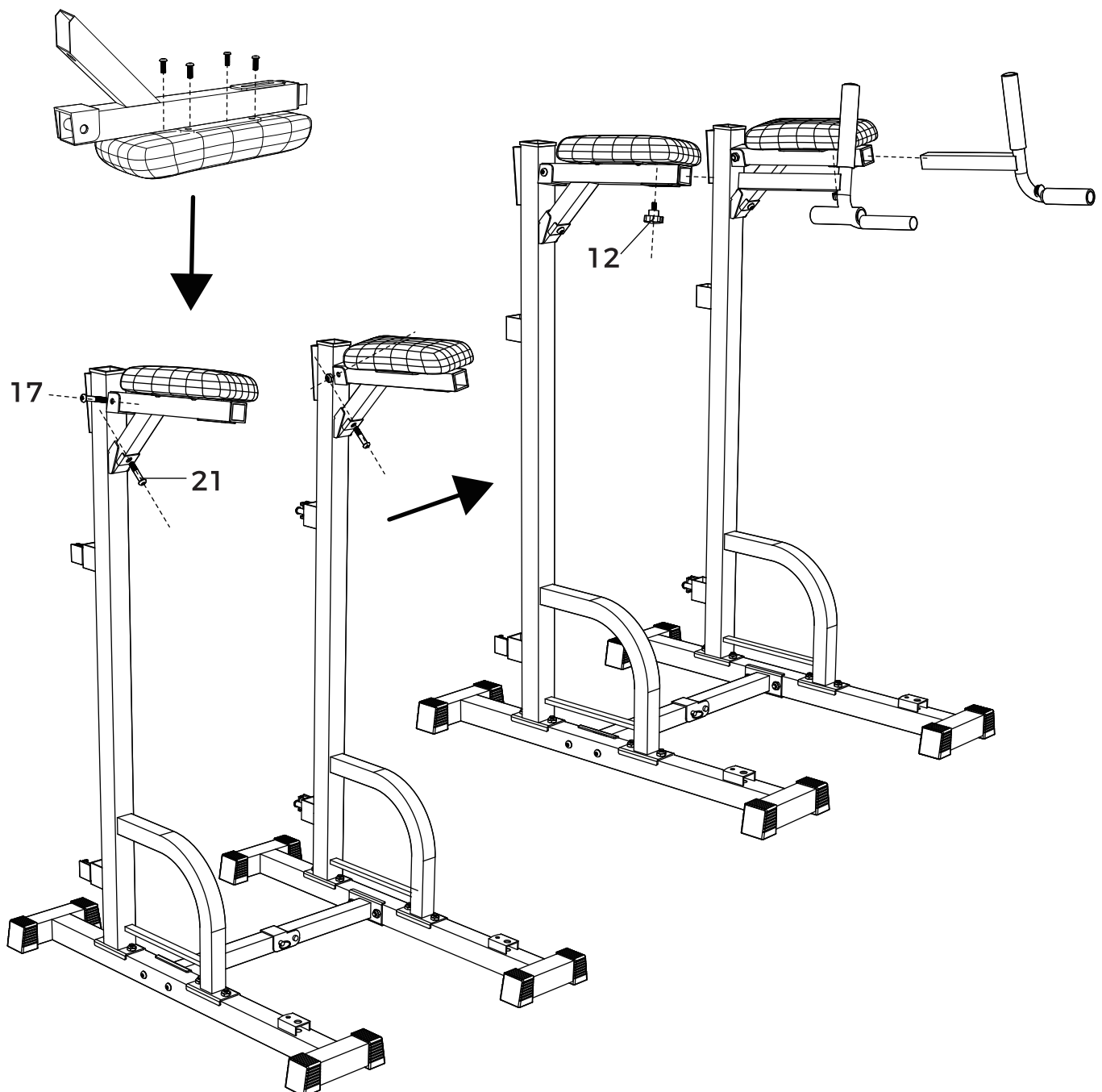

# Assembly Instructions



## Step 3

- Insert the telescopic tubes into the vertical tubes ,Lock the pull-up bar and telescopic tubes with M10\*70 screw (#18) and M10 Knob (#19)
- Adjust both sides of the telescopic tubes to the same height arnd then tighter it with M10\*65 knob (#35) .

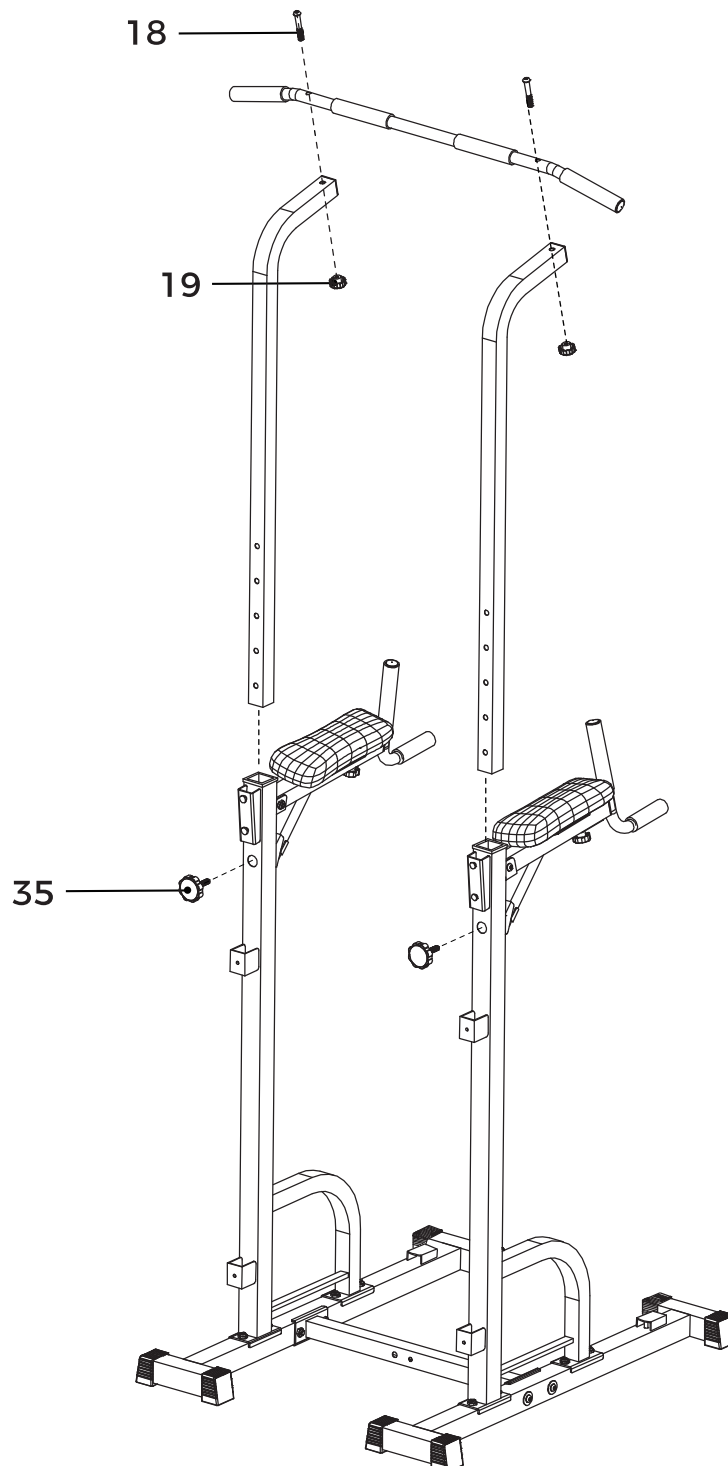

# Assembly Instructions



## Step 4-1

- Connect the vertical tube crossbar and composite tube using M12\*16 screws (#38). Note: #38 screws are pre-installed on the product. then, secure the vertical tube crossbar to the vertical tube using M8\*50 screws (#22) and M8\*16 flat washers (#15).
- Insert the pulley wheel frame into the composite tube.
- Insert the stretch wheel frame into the upper part of the composite tube; secure the stretch wheel frame and vertical tube using M8\*50 screws (#22) and M8\*16 flat washers (#15), while simultaneously tightening the composite tube and stretch wheel frame with M12\*16 screws (#38).

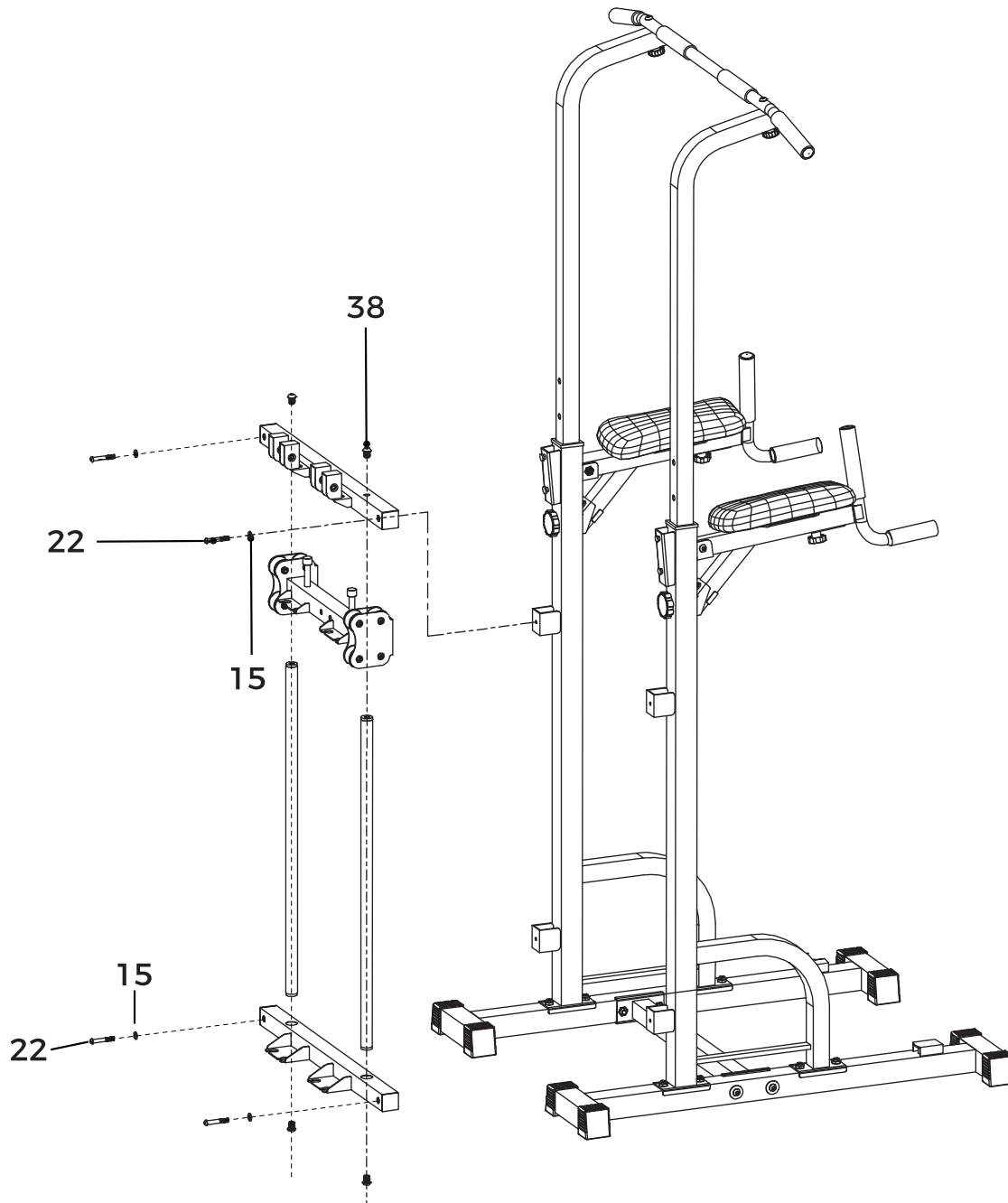

# Assembly Instructions



## Step 4-2

- Secure the four pull cords and four rollers to the stretch wheel frame (#9) using M8\*30 screws(#20) and M8 nuts (#16).

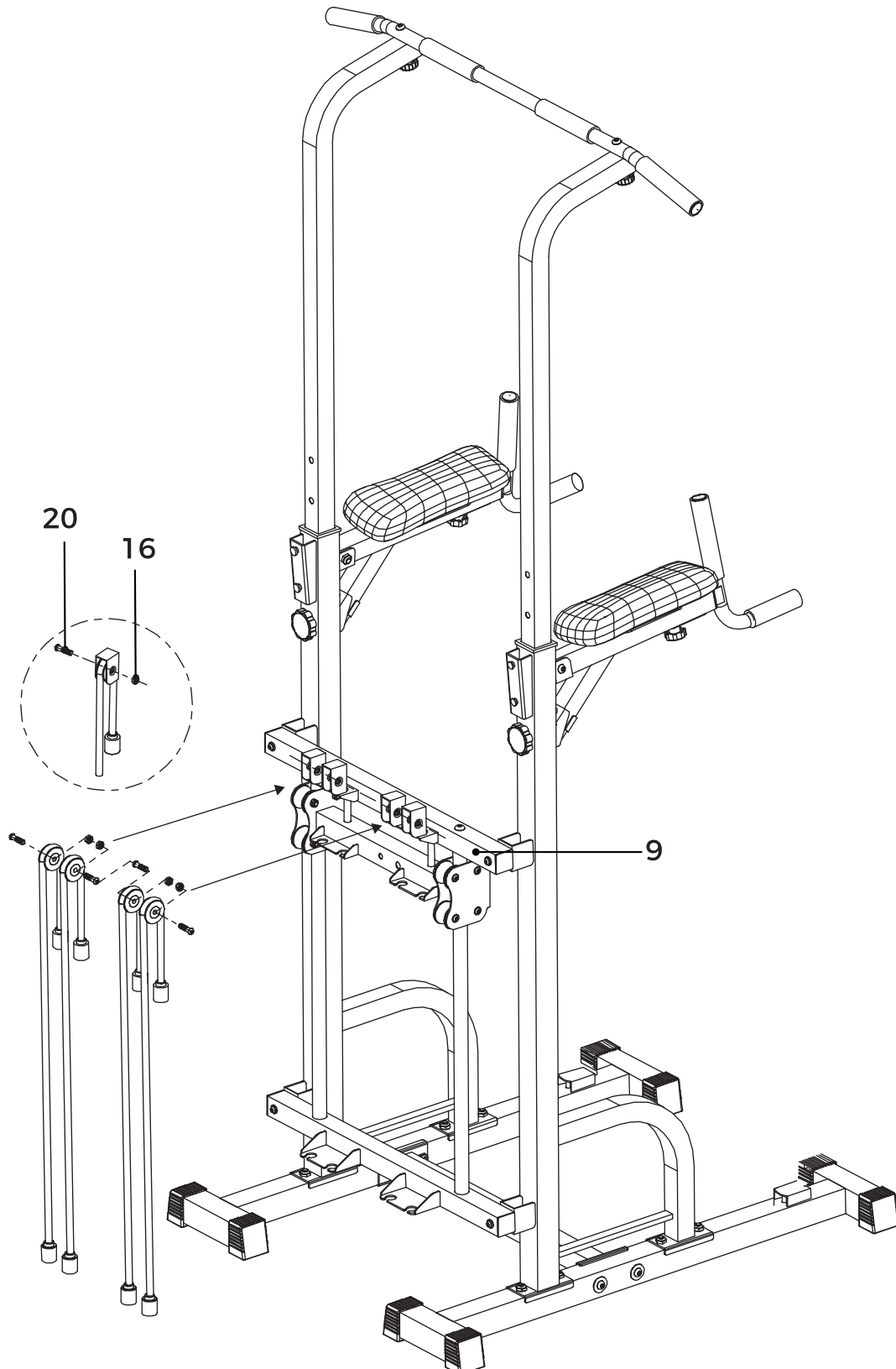

# Assembly Instructions



## Step 5

- Secure the middle cushion shelf using M8\*16 screws (#34) and M8\*50 screws(#22). (Note: #34 screws are pre-installed on the product.) Then, use the M16 knob (#23) to secure the cushion telescopic shelf and middle cushion shelf (Note:the cushion telescopic shelf needs to be divided into left and right parts).
- Align the middle cushion shelf with the pulley wheel frame and snap it into place, then secure it with (#27) M10\*80 Latch.

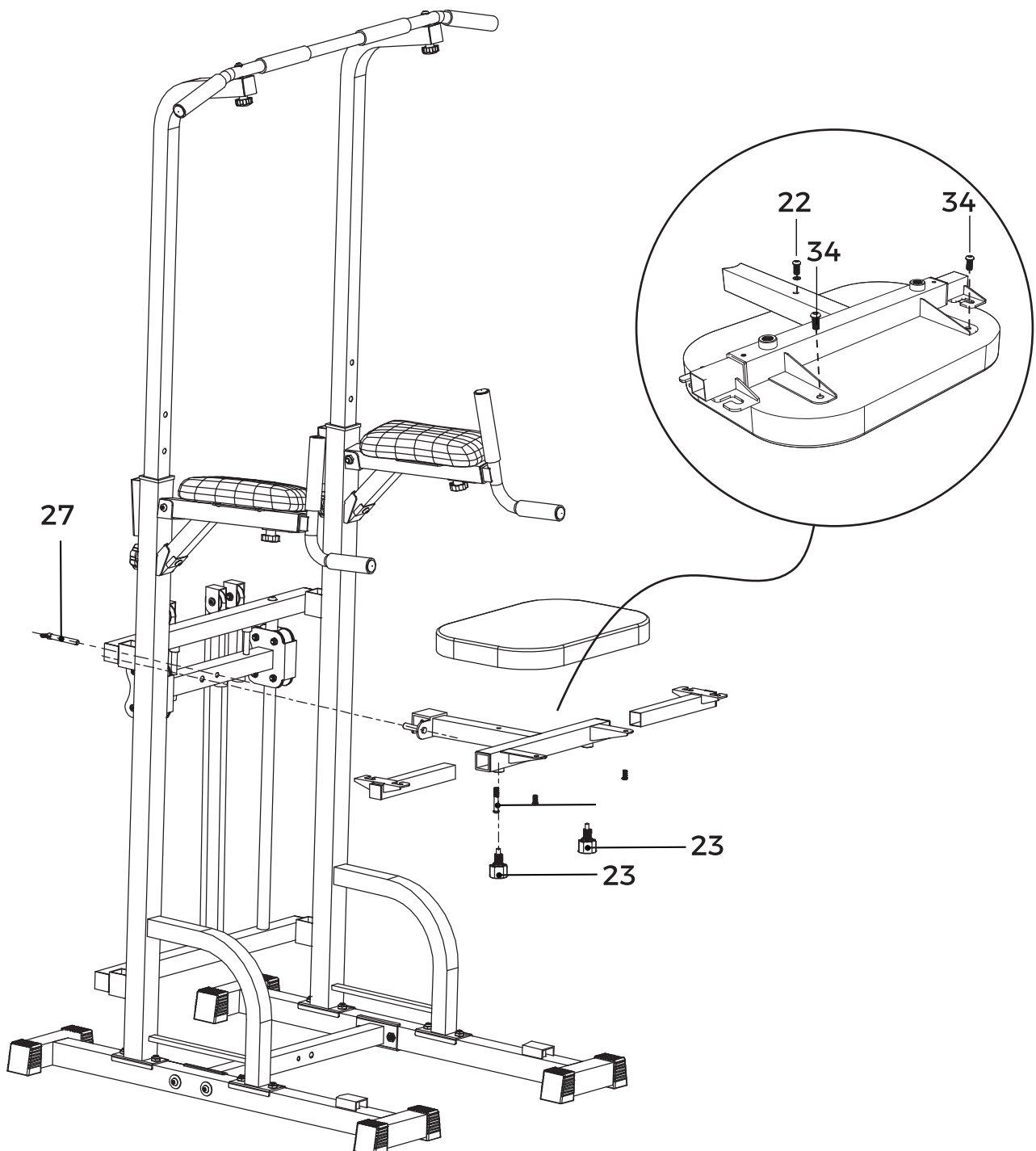

# Assembly Instructions



## Step 6

- Insert the anti-crash frame (note: this shelf needs to be inserted into the round hole first before flipping it over) into the base crossbar then locking with M8\*68 latch (#25) .
- Take out the push-up handles and lock the handles with M8\*12 Screw + Spring Washer + Flat Washer (#14) . (Please note: #14 screw are pre-installed on the product)
- Use M8\*68 latch (#25) to adjust the Push-up Handle.

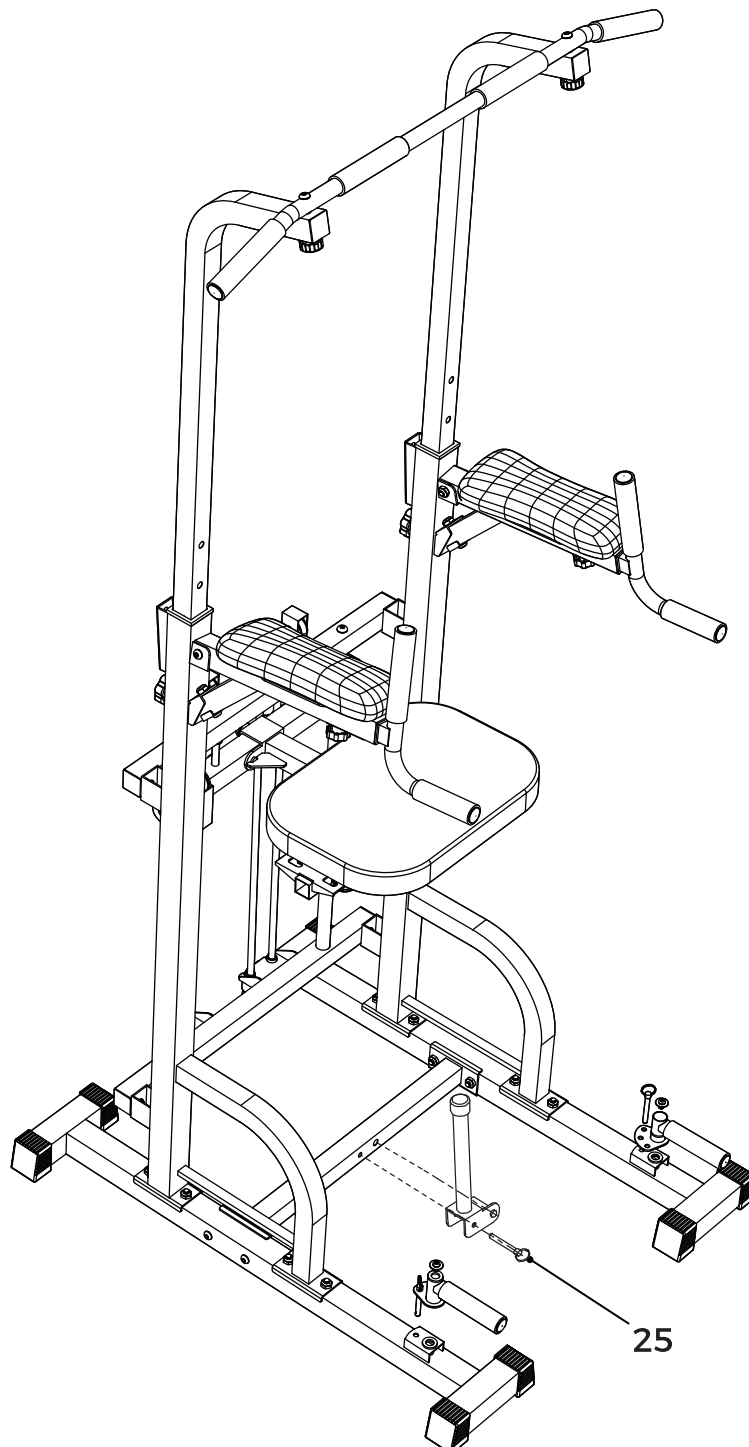

# Assembly Instructions

## Attention

When you need to do pull-ups, just remove the middle cushion shelf, and then use the cushion telescopic shelf to snap the corresponding position on the vertical tube.

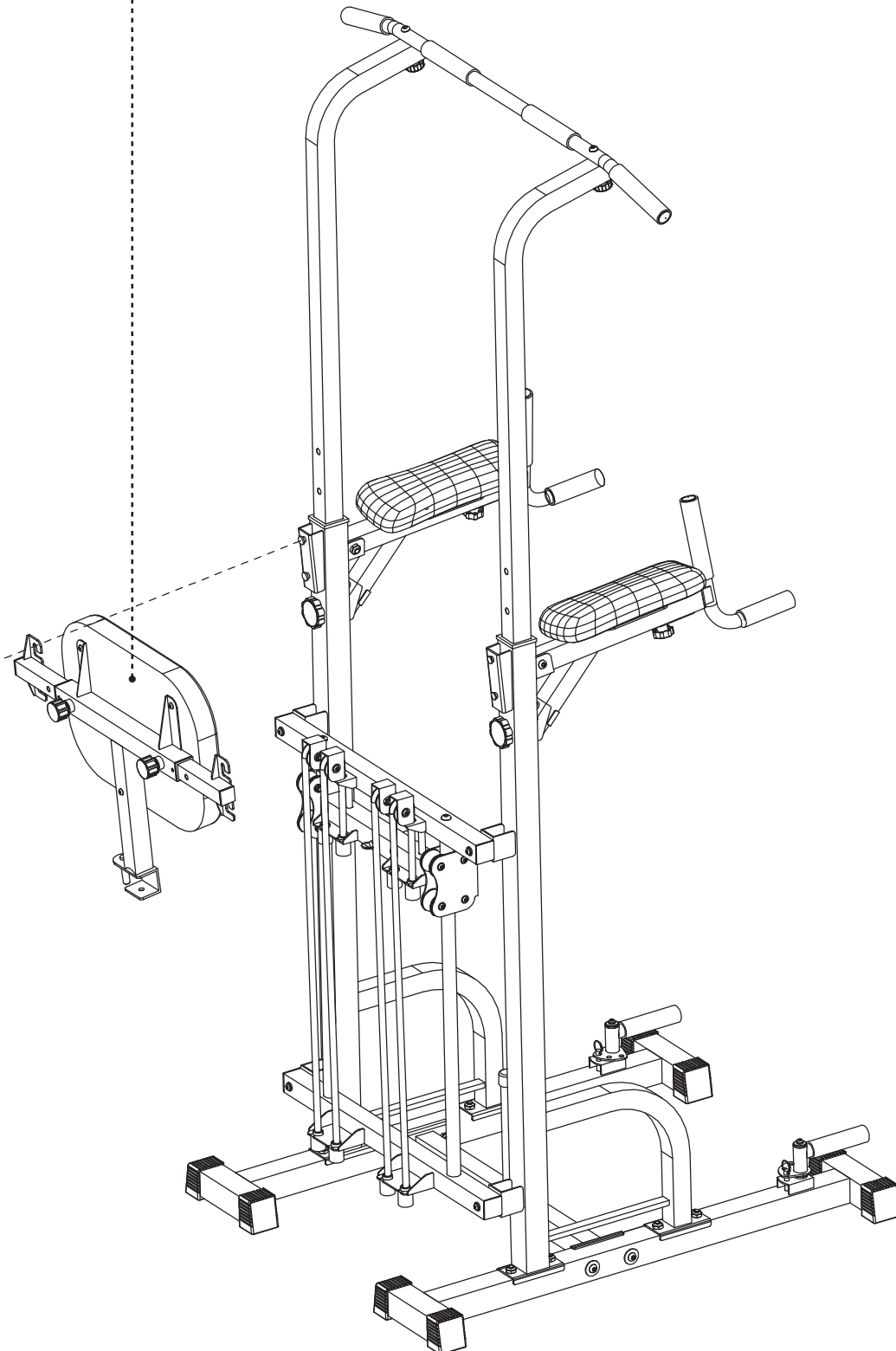

# Warranty

We offer a 2-year warranty for this product. If any parts need to be replaced during normal use, we will be glad to provide free support.

If you need replacement parts or support from the seller, please contact us via Amazon (Login your amazon account > choose "Your orders" > find the orderID > click "Contact seller").

Or email to [support@sportsroyals.com](mailto:support@sportsroyals.com).

Our customer service representative will reach you within 24 hours.

In order to resolve your issue faster, please include the following information in your email when contacting us.

Order Number

-----

Product

-----

Issue

-----

Request

-----

Address

-----

Phone Number

-----



---

Follow Us on Social Media @fedfitness



Email: [support@sportsroyals.com](mailto:support@sportsroyals.com)