

# **ASSEMBLY INSTRUCTIONS**

QUEEN SIZE

# ASSEMBLY INSTRUCTIONS

## Notice:

1. Follow the installation instructions. Please confirm all accessories are preset before installation.
2. Do not fully tighten the screws during initial assembly. Fully tighten screws only all pieces are correctly assembled.
3. If you encounter any problems during installation, please contact our customer service.
4. Please put a carpet on the floor to avoid scratching it.



Recommended installers : 2









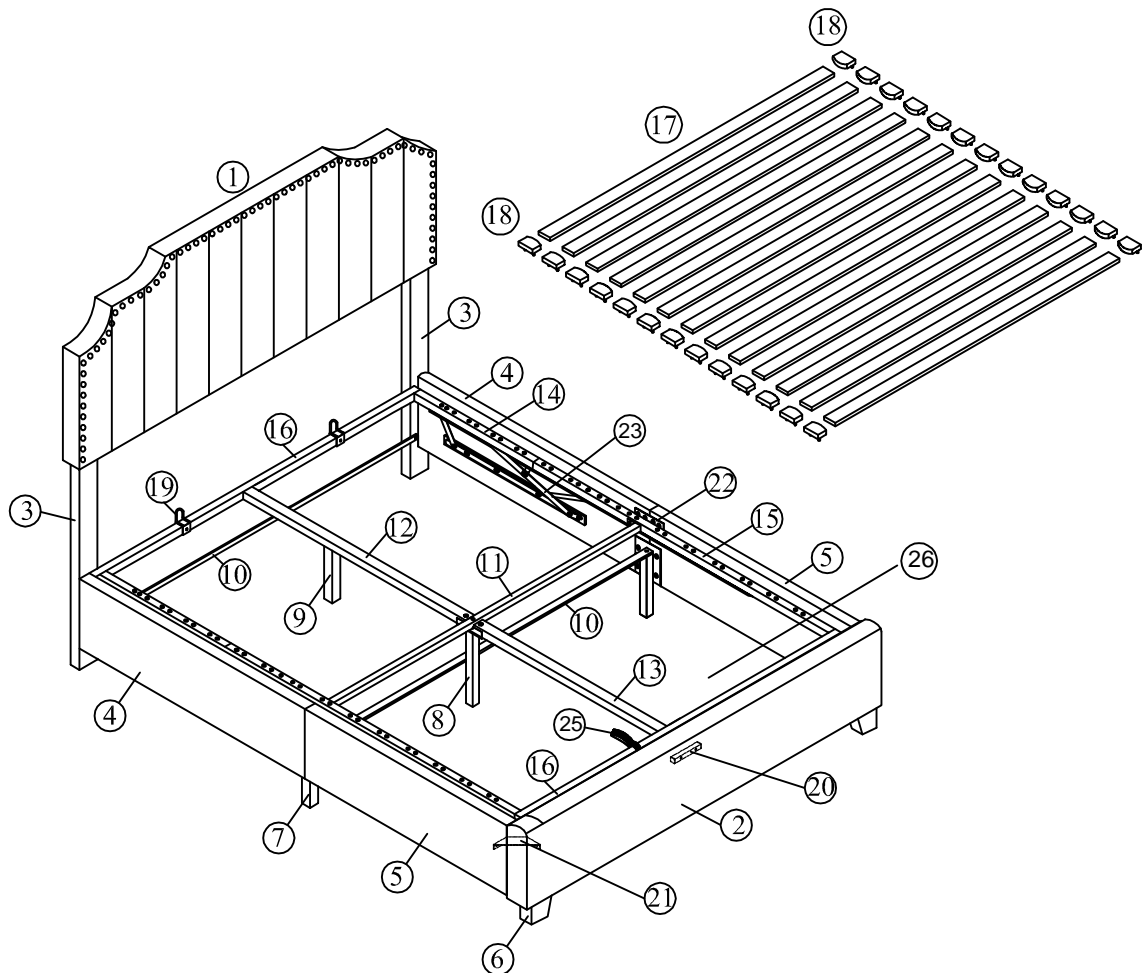



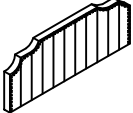
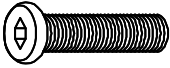
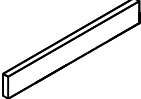

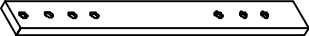
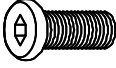
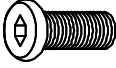
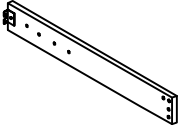
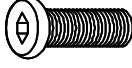
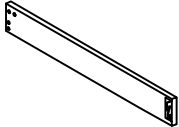
Put a carpet on the floor  
before unpacking



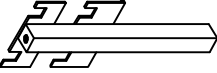

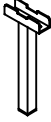

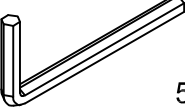
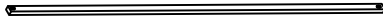
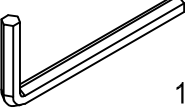
Estimate installation time:  
30 minutes

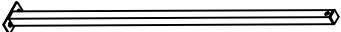
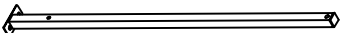

# ASSEMBLY INSTRUCTIONS

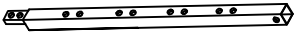
Item NO.	Reference Image	Qty	Item NO.	Reference Image	Qty
1		1PC	A	 ø5/16"X55mm	10+1PCS
2		1PC	B	 ø5/16"X45mm	22+3PCS
3		2PCS	C	 ø5/16"X25mm	14+2PCS
			D	 ø1/4"X35mm	8PCS
4		2PCS	E	 ø1/4"X15mm	26+3PCS
5		2PCS	F	 ø5/16"	18+2PCS
6		2PCS	G	 ø5/16"X19mm	46+6PCS
7		2PCS	H	 ø1/4"X16mm	34+3PCS
8		1PC	I	 ø5/16"	46+6PCS
9		1PC	J	 5/16"x 100mm	1PC
10		2PCS	K	 1/4"x 100mm	1PC
11		1PC	L	 5/16"	1PC
12		1PC			
13		1PC			

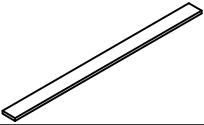
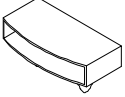
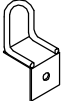
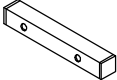
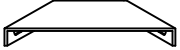
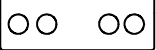
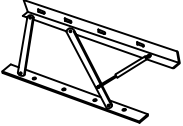
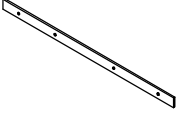

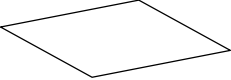

# ASSEMBLY INSTRUCTIONS

Item NO.	Reference Image	Qty	Item NO.	Reference Image	Qty
14		2PCS			
15		2PCS			
16		2PCS			
17		13PCS			
18		26+3PCS			
19		2PCS			
20		1PC			
21		2PCS			
22		2PCS			
23		2PCS			
24		2PCS			
25		1PC			
26		1PC			

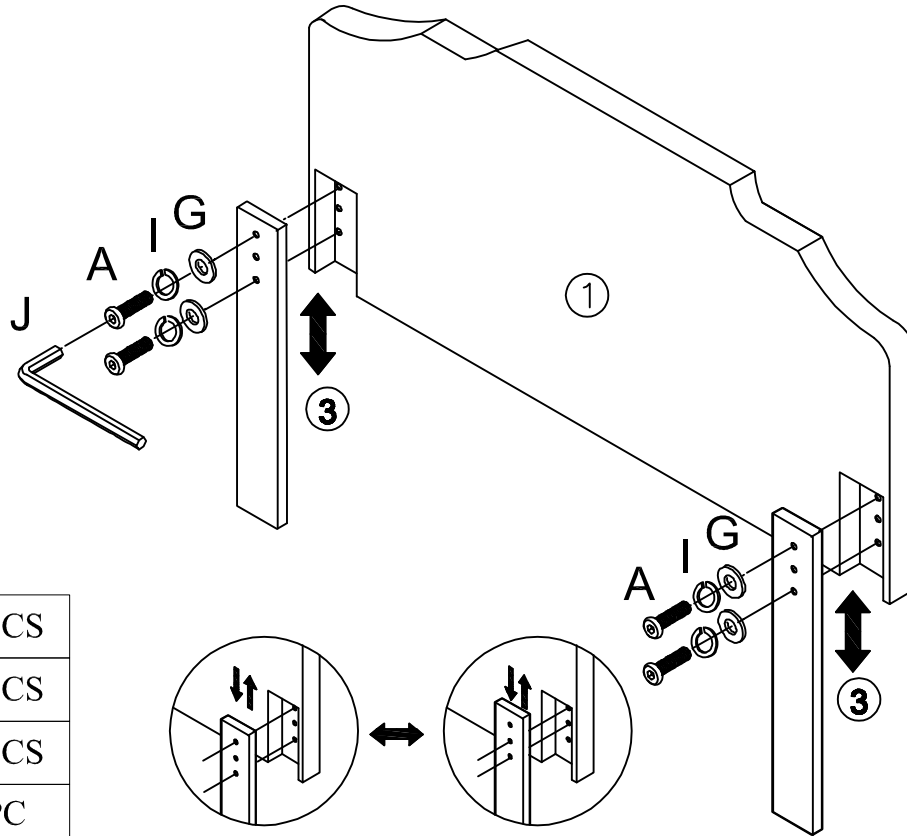
# ASSEMBLY INSTRUCTIONS

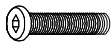



## STEP 1

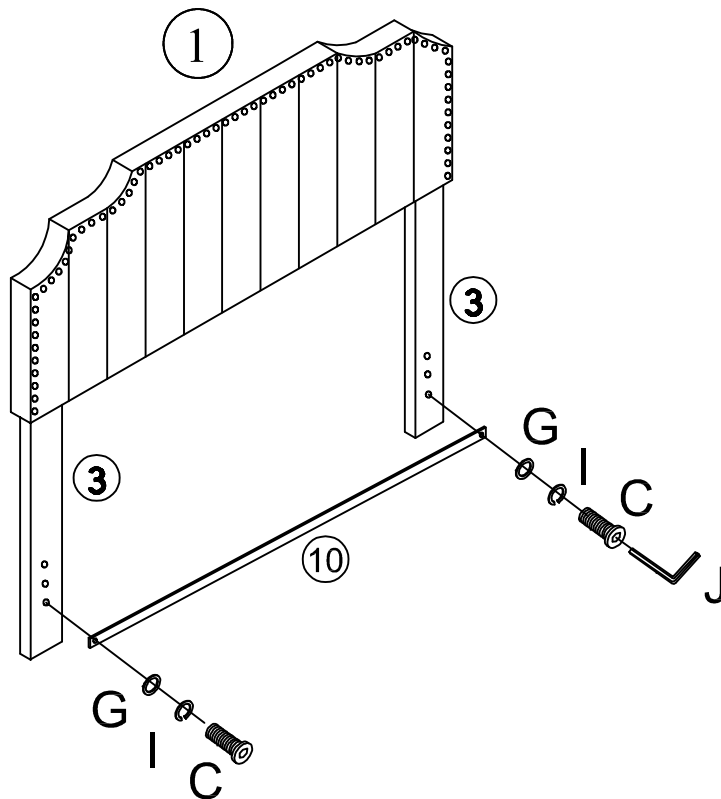

	A x 4PCS
	G x 4PCS
	I x 4PCS
	J x 1PC

## STEP 2





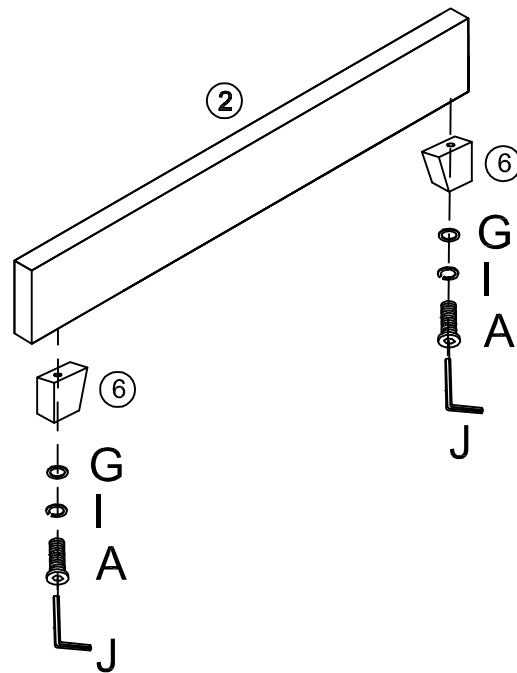

	C x 2PCS
	G x 2PCS
	I x 2PCS
	J x 1PC

# ASSEMBLY INSTRUCTIONS



## STEP 3

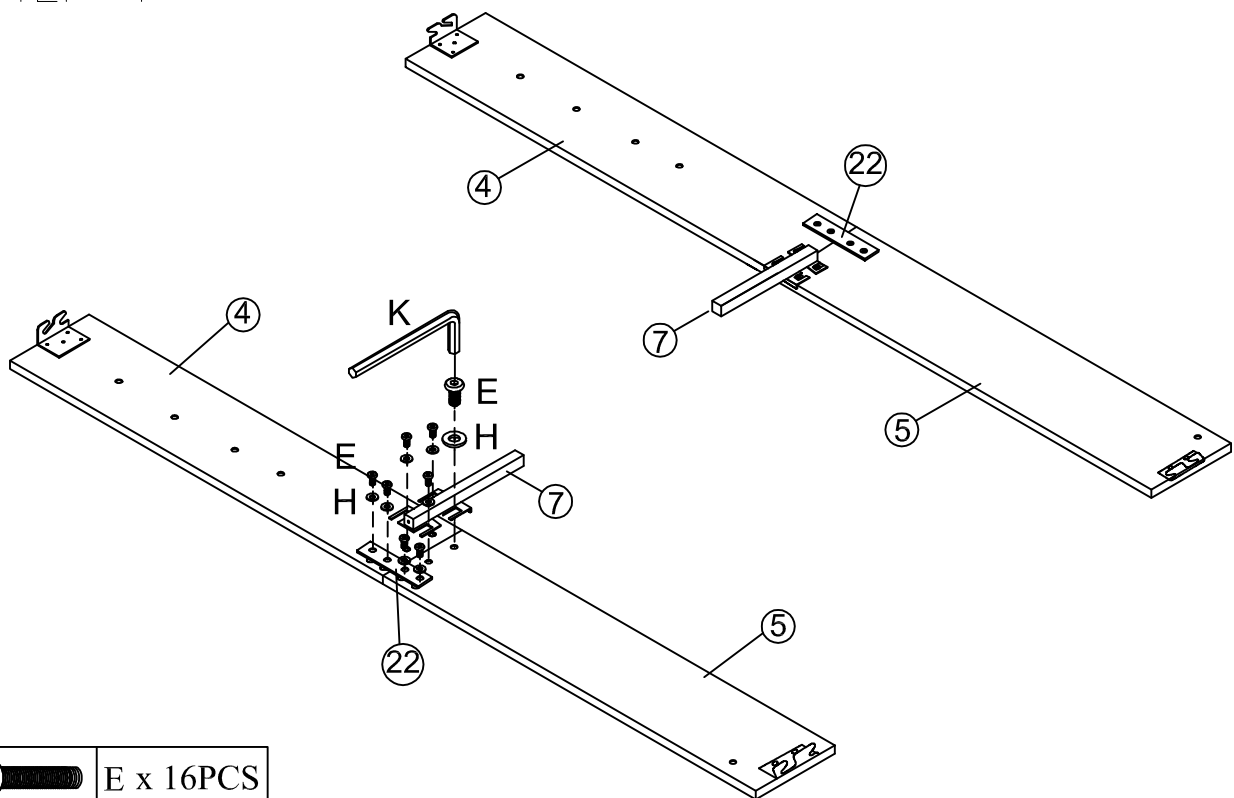

	A x 2PCS		G x 2PCS
	J x 1PC		I x 2PCS

## STEP 4



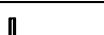

	E x 16PCS
	H x 16PCS
	K x 1PC

# ASSEMBLY INSTRUCTIONS

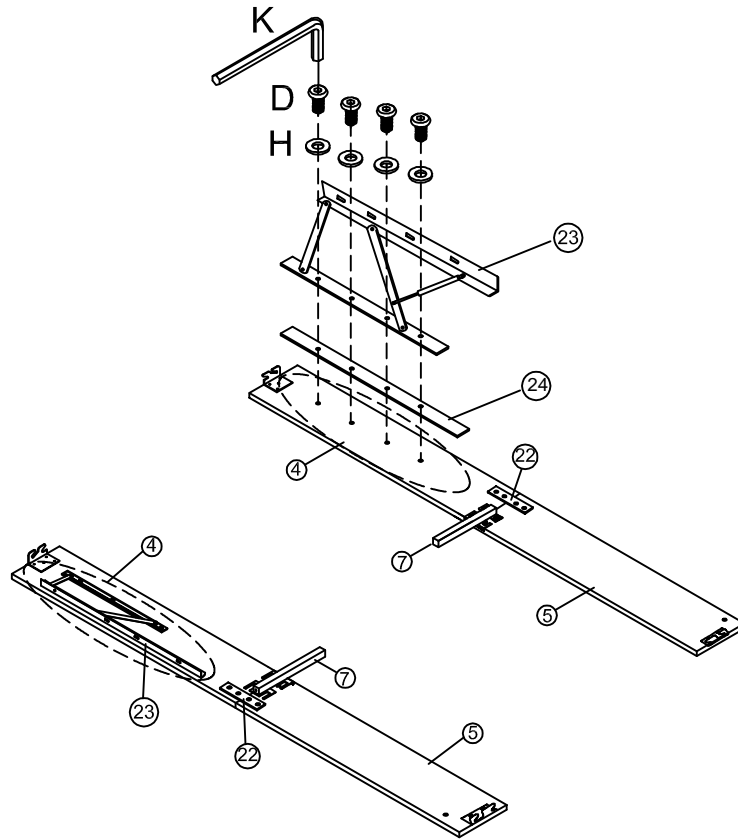



## STEP 5

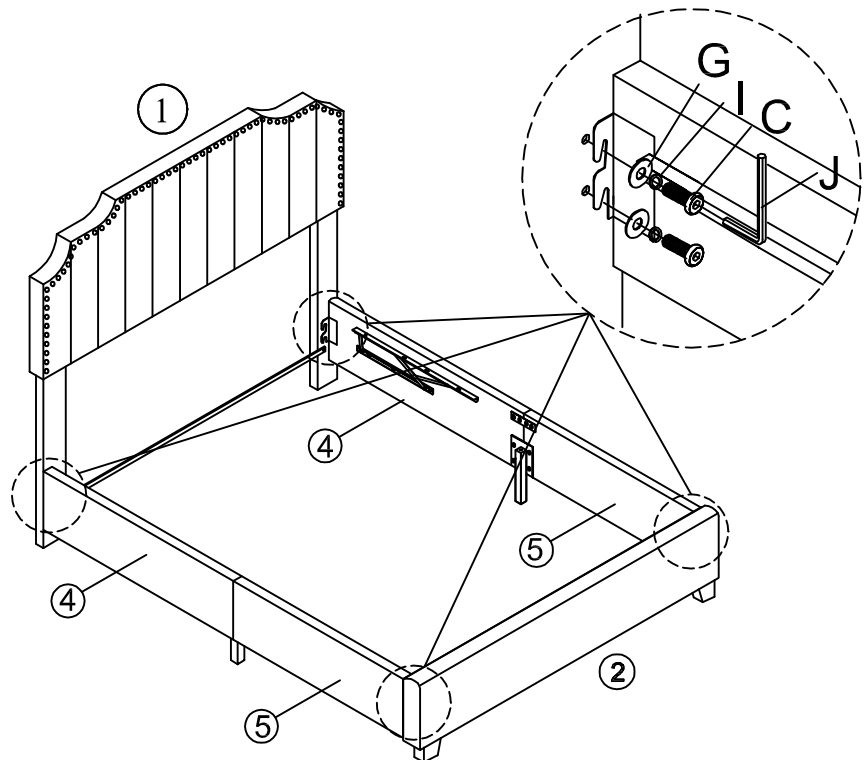

	D x 8PCS
	H x 8PCS
	K x 1PC

## STEP 6



	C x 8PCS
	G x 8PCS
	I x 8PCS
	J x 1PC

# ASSEMBLY INSTRUCTIONS

## STEP 7

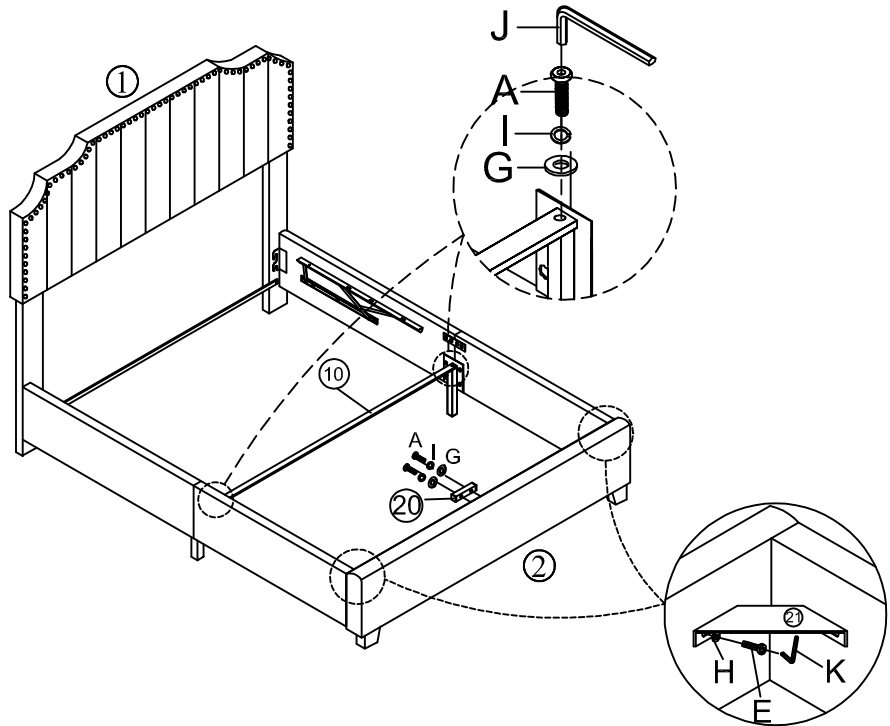

	A x 4PCS
	E x 4PCS
	I x 4PCS
	Gx 4PCS
	Hx 4PCS
	J x 1PC
	K x 1PC

## STEP 8

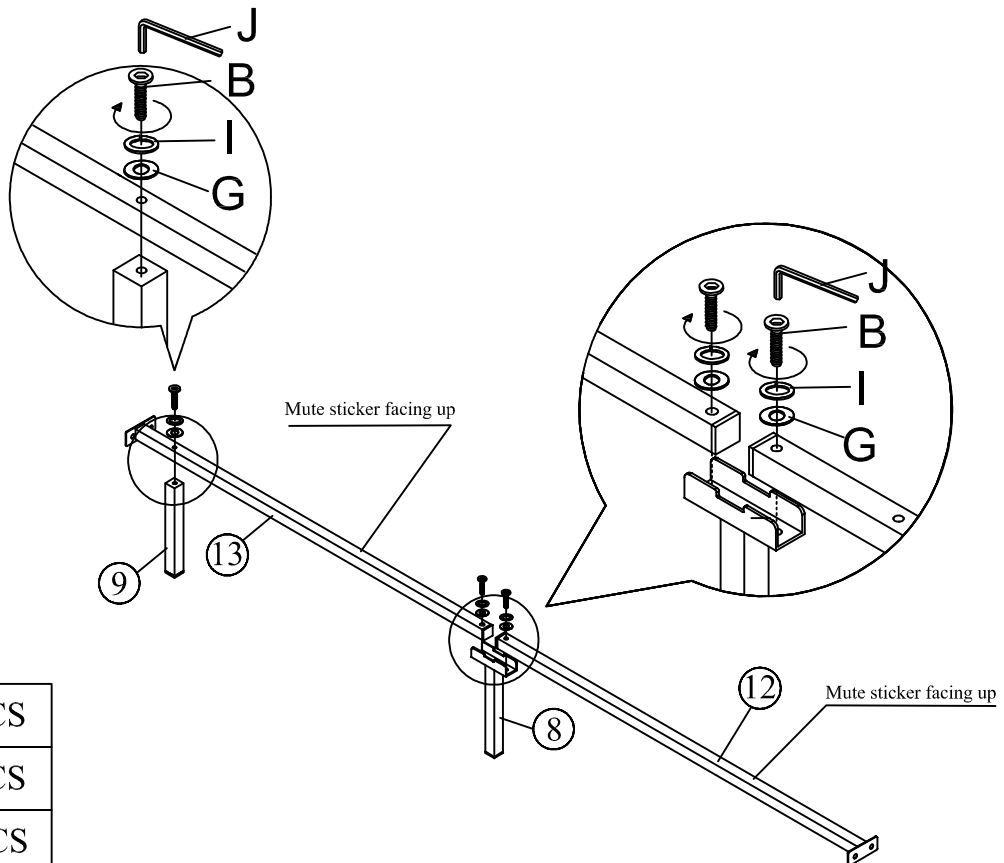

	B x 3PCS
	I x 3PCS
	G x 3PCS
	J x 1PC

# ASSEMBLY INSTRUCTIONS

## STEP 9

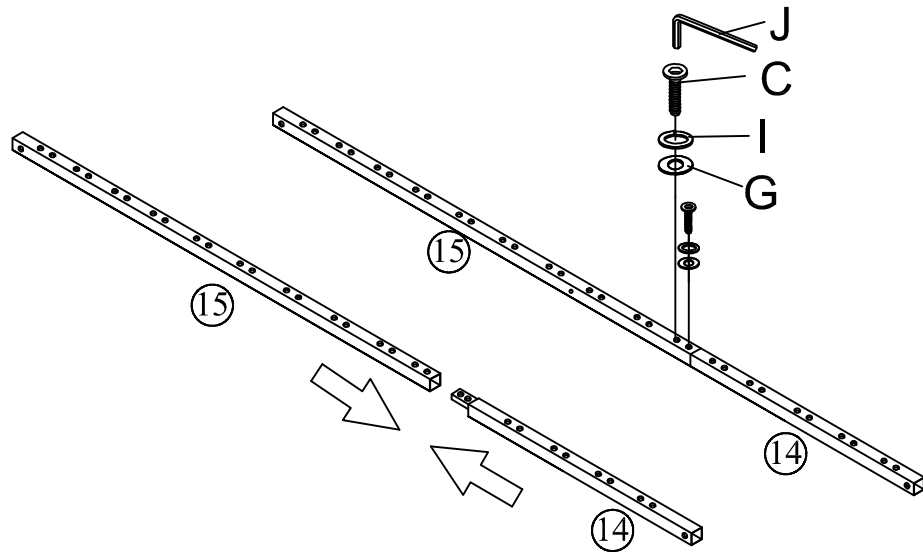

	C x 4PCS
	I x 4PCS
	G x 4PCS
	J x 1PC

x 2

## STEP 10

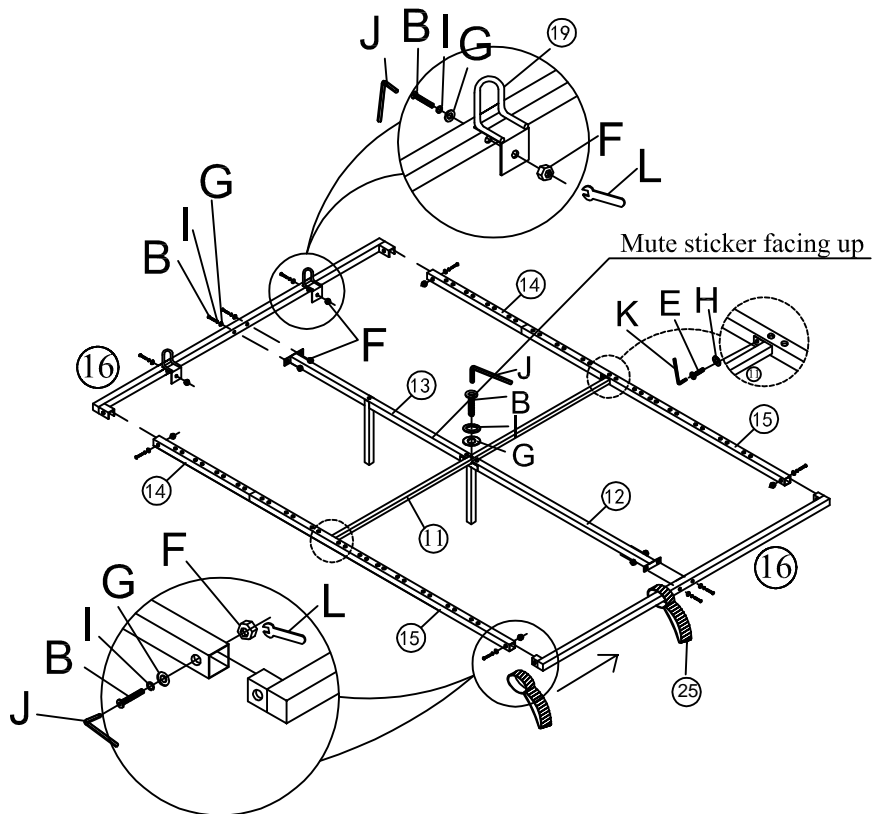





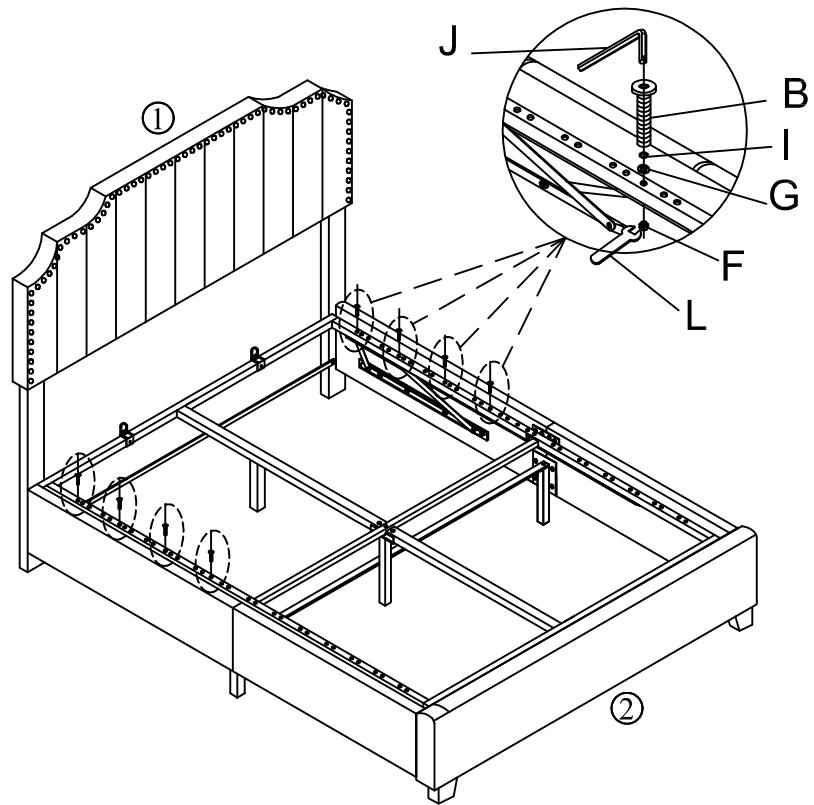

	B x 11PCS
	E x 2PCS
	I x 11PCS
	H x 2PCS
	G x 11PCS
	F x 10PCS
	L x 1PC
	J x 1PC
	K x 1PC

# ASSEMBLY INSTRUCTIONS

## STEP 11



	B x 8PCS
	I x 8PCS
	F x 8PCS
	F x 8PCS
	L x 1PC
	J x 1PC

## STEP 12

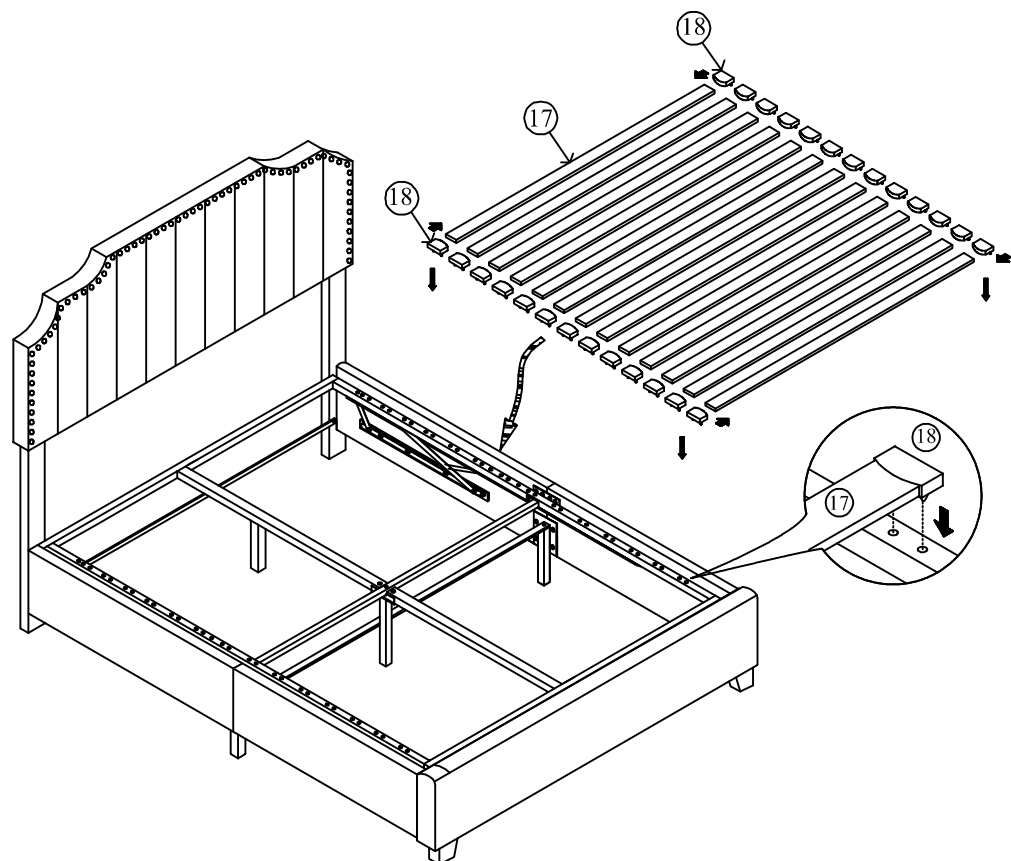

# ASSEMBLY INSTRUCTIONS

## STEP 13

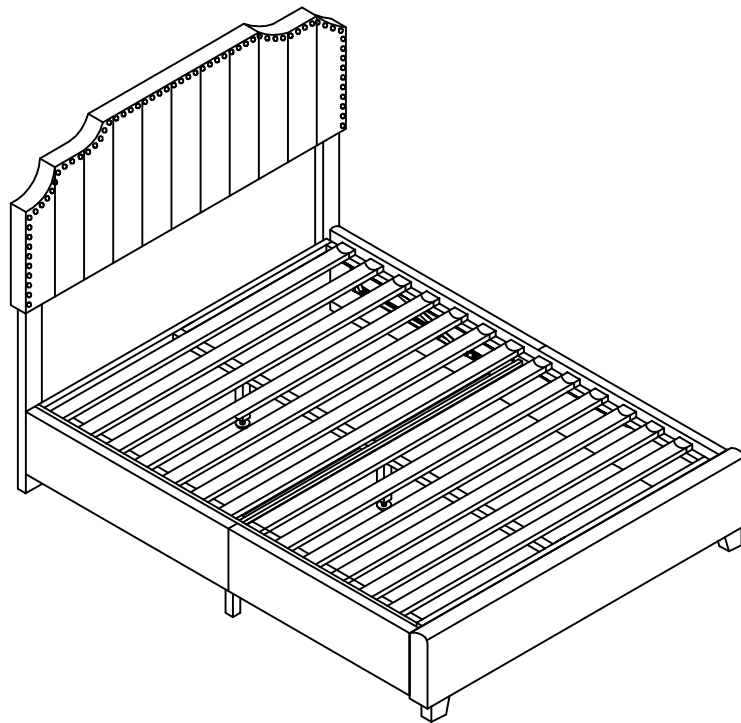

## STEP 14

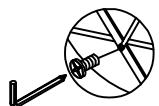
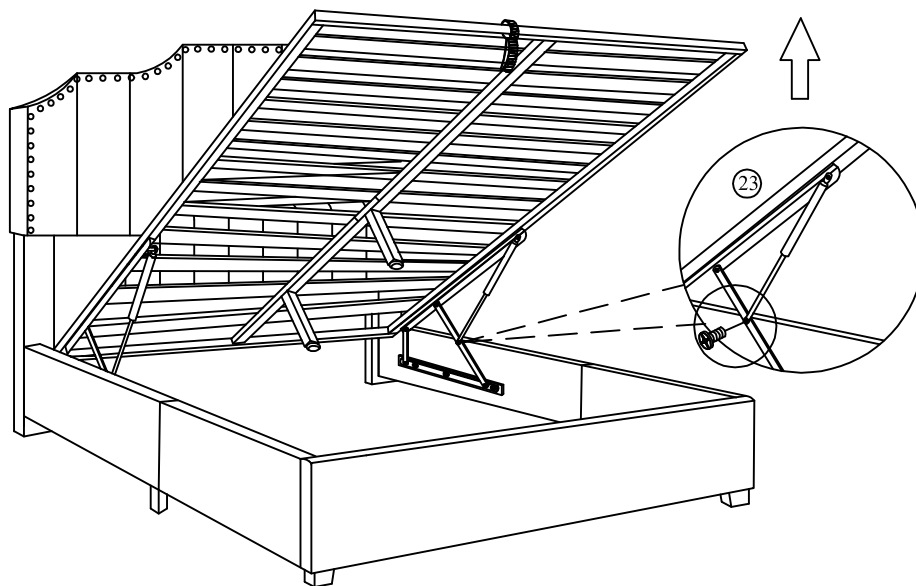

**SCHRAUBEN SIE DIESE SCHRAUBE (1 STÜCK) VON TEIL H AB;  
HEBEN SIE DANN DIE BASIS AUF DIE MAXIMALE HÖHE AN.  
SCHRAUBEN SIE DEN BOLZEN FEST AN ;**

# ASSEMBLY INSTRUCTIONS

STEP 15

