

# INSTRUCTION

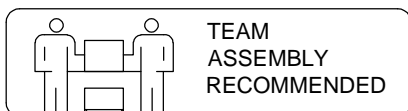
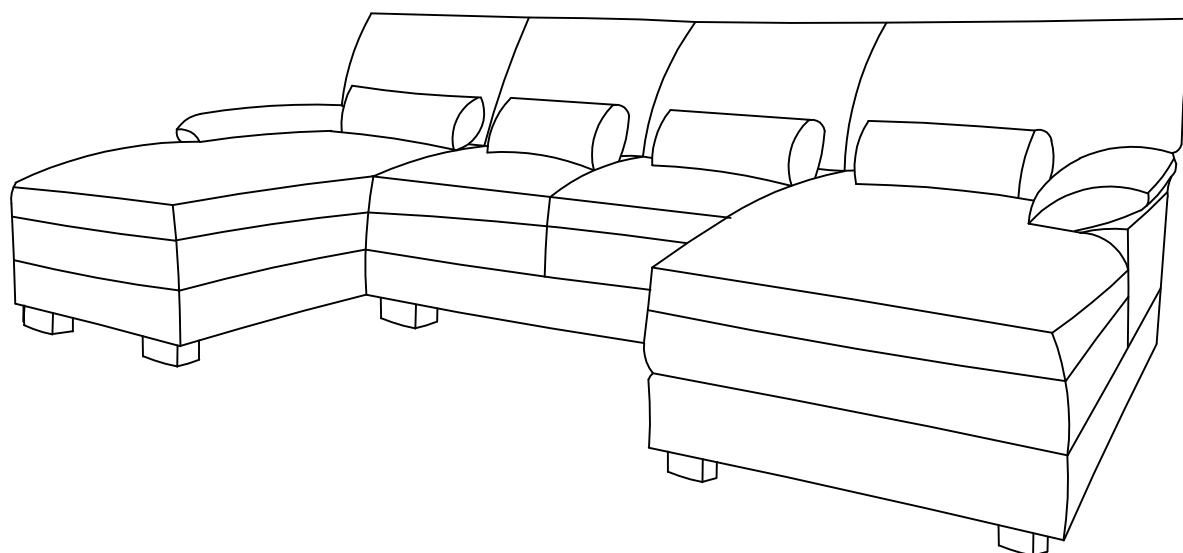

TEAM  
ASSEMBLY  
RECOMMENDED

**SOFA**

# PARTS LIST

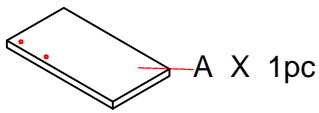

A X 1pc

L- seat panel

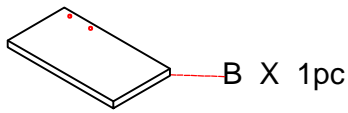

B X 1pc

R- seat panel

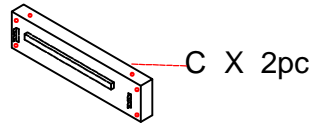

C X 2pc

Chaise seat frame(back)

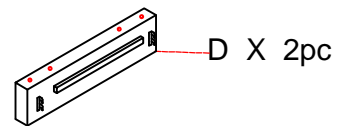

D X 2pc

Chaise seat frame(front)

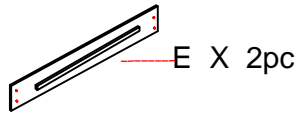

E X 2pc

Chaise seat frame-L

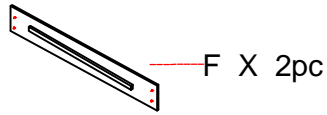

F X 2pc

Chaise seat frame-R

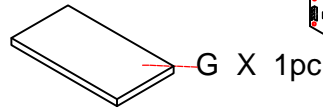

G X 1pc

Middle seat panel

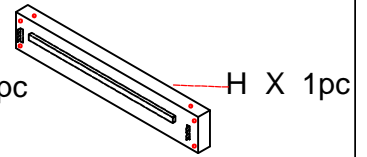

H X 1pc

Middle seat frame(back)

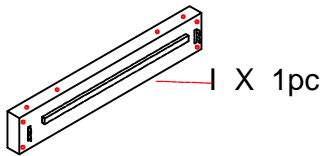

I X 1pc

Middle seat frame(front)

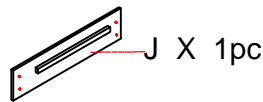

J X 1pc

Middle seat frame-L

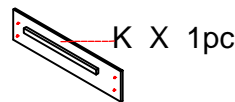

K X 1pc

Middle seat frame-R

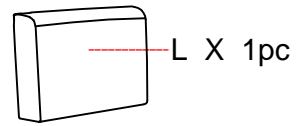

L X 1pc

Left arm

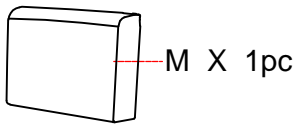

M X 1pc

Right arm

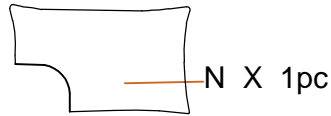

N X 1pc

L-back cushion

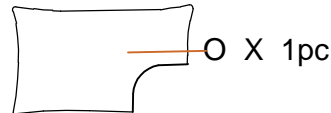

O X 1pc

R-back cushion



P X 1pc

Left Armrest Bag

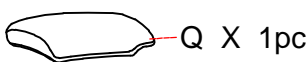

Q X 1pc

Right Armrest bag

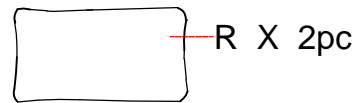

R X 2pc

M-back cushion

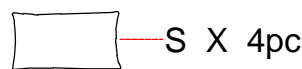

S X 4pc

Pillow

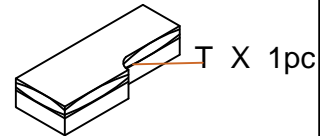

T X 1pc

Left cushion

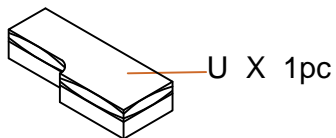

U X 1pc

Left cushion

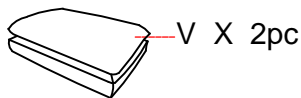

V X 2pc

Middle cushion

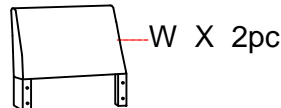

W X 2pc

L&R Backrest

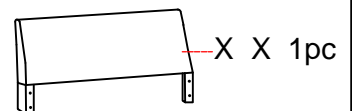

X X 1pc

Middle Backrest

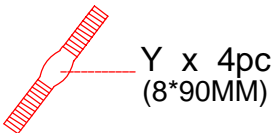

Y x 4pc  
(8\*90MM)

Long screw(arm)

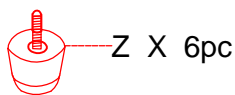

Z X 6pc

Back Legs

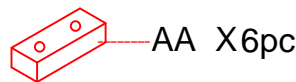

AA X6pc

Front Legs

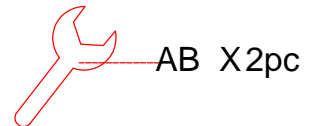

AB X2pc

Wrench

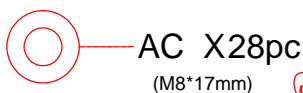

AC X28pc  
(M8\*17mm)

Washers

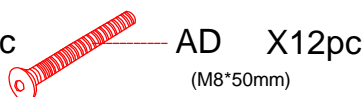

AD X12pc  
(M8\*50mm)

Screws

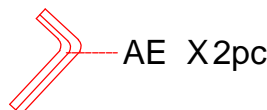

AE X2pc

L-Shaped Wrench

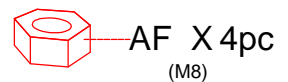

AF X4pc  
(M8)

Nuts

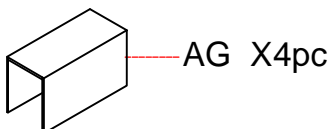

AG X4pc

Connection hook

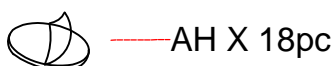

AH X 18pc

Felt



AY X12pc  
(M8\*60mm)

Leg screws

## STEP 1 Ship by 3 boxes

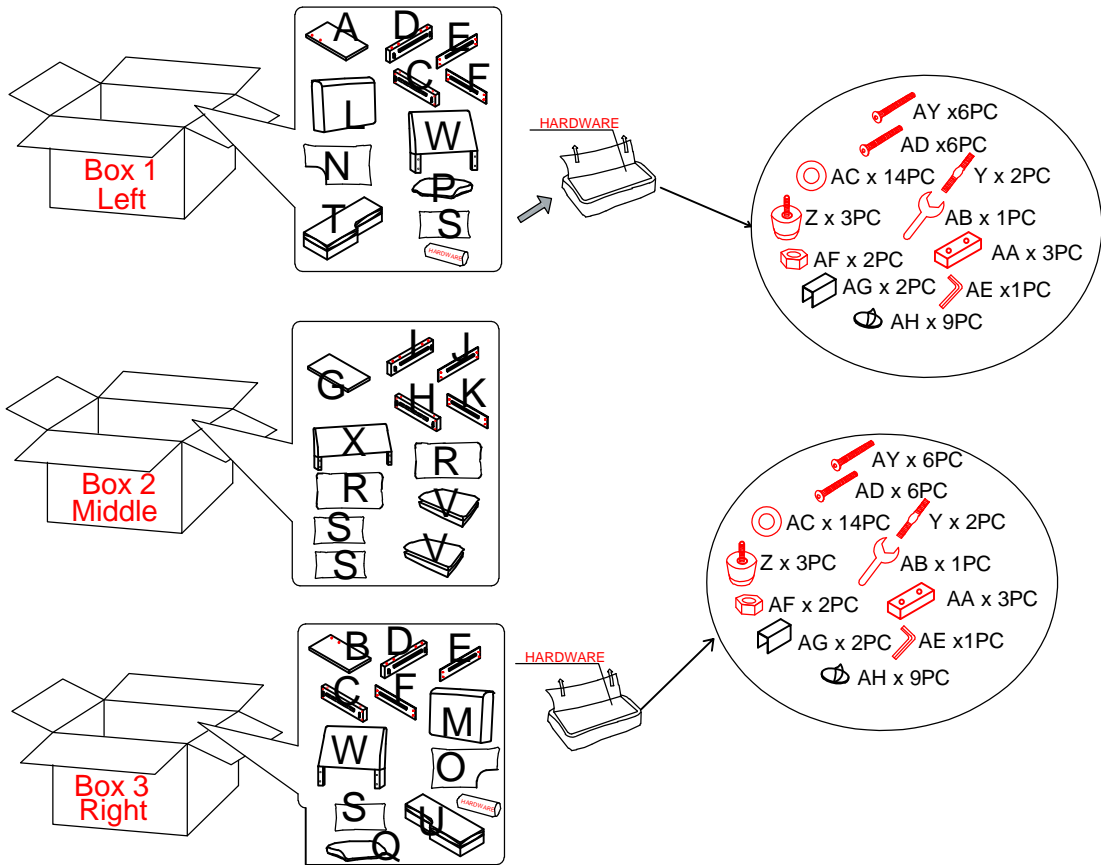

Sofa parts can be found in the BOX.

## STEP 2

Left

Attach the felt after install the legs.

Remove the plastic covers ahead before screw in the legs.

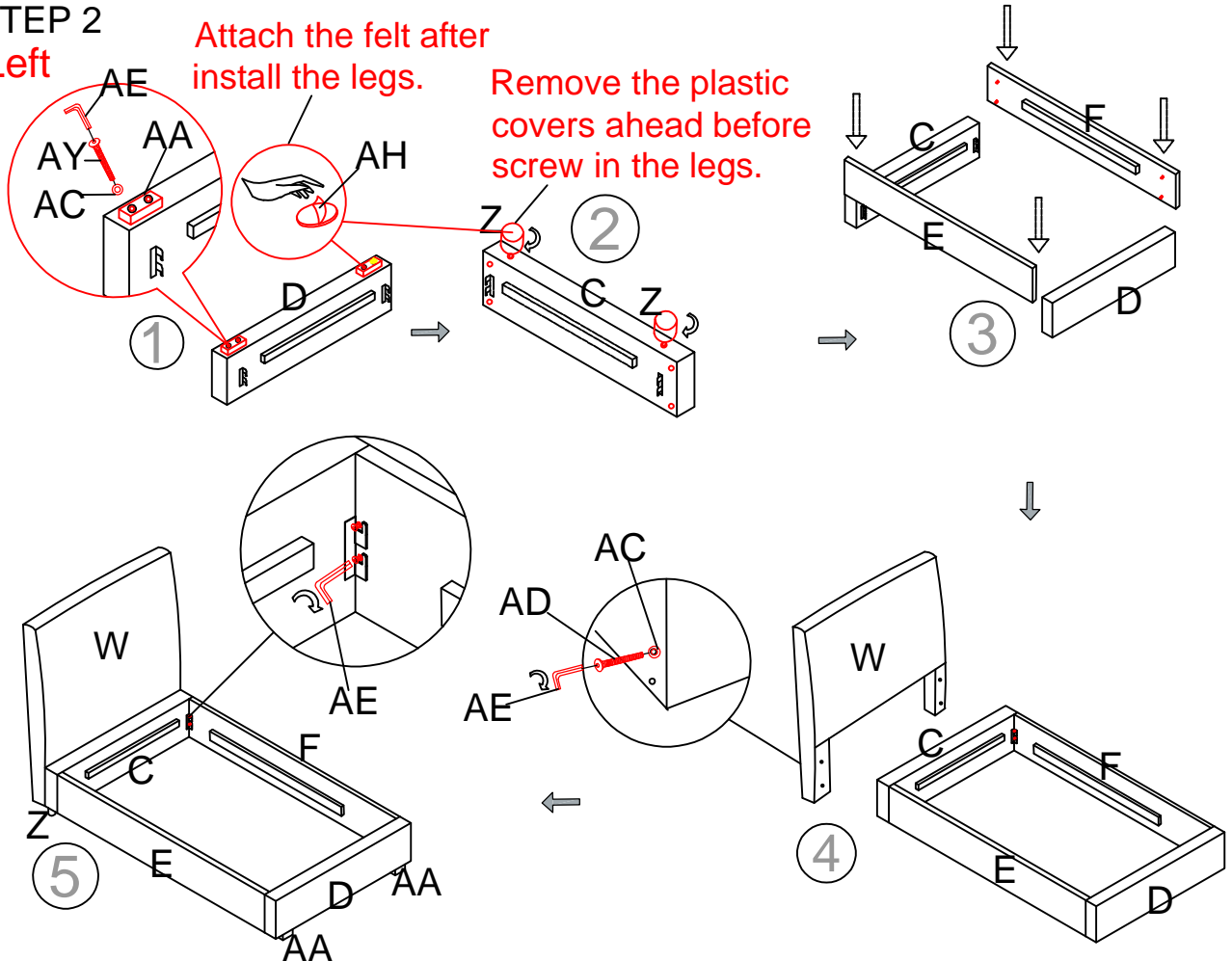

### STEP 3

**Left** Do not over-tighten the screws during assembly.

Put the panel on the frame.

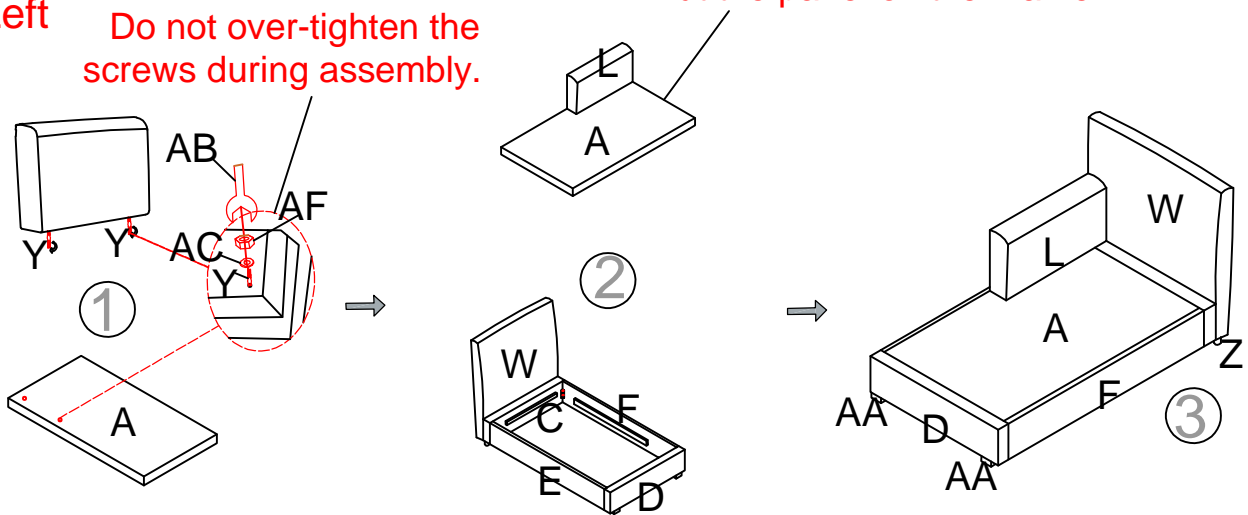

### STEP 4

**Middle** Attach the felt after install the legs.

Remove the plastic covers ahead before screw in the legs.

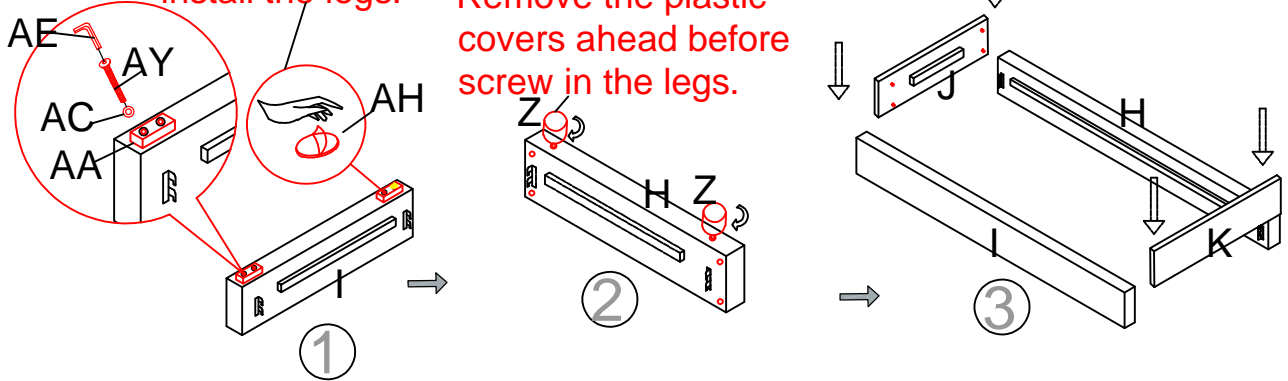

Put the panel on the frame.

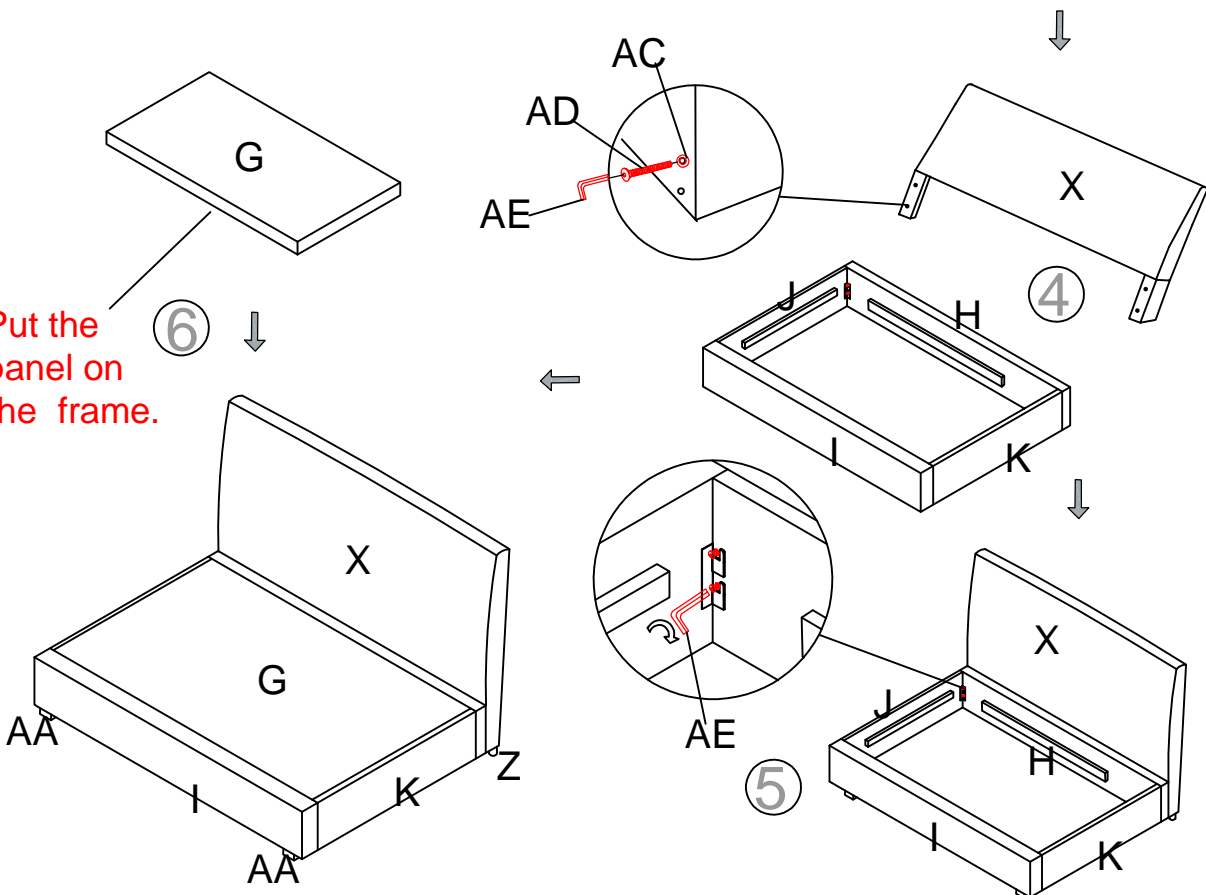

### STEP 5

Right

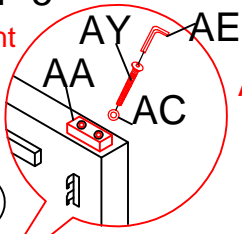

Attach the felt after install the legs.

1

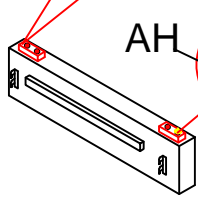

2

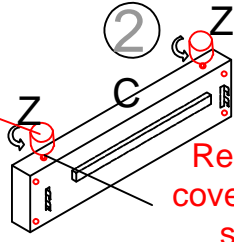

Remove the plastic covers ahead before screw in the legs.

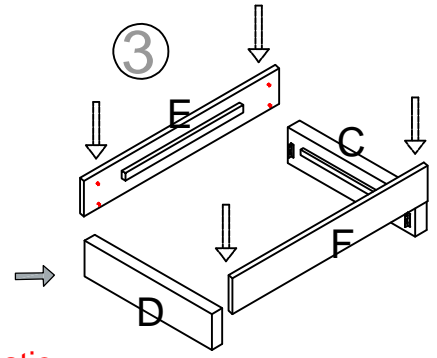

3

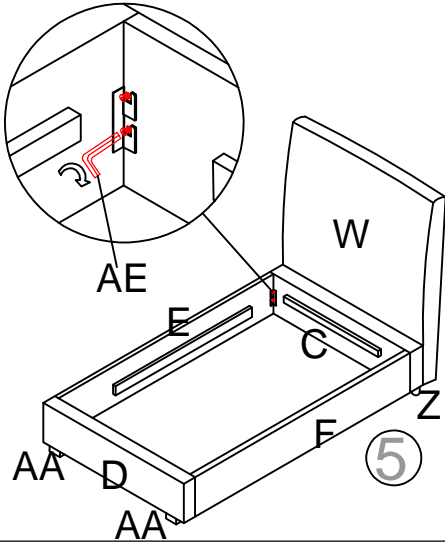

5

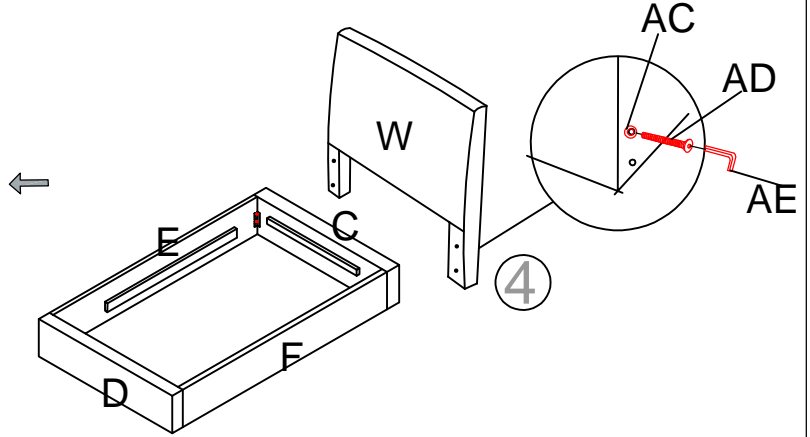

4

### STEP 6

Right

Do not over-tighten the screws during assembly.

Put the panel on the frame.

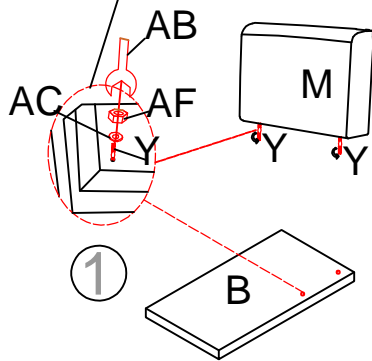

1

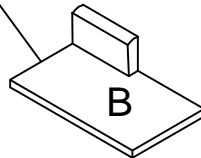

2

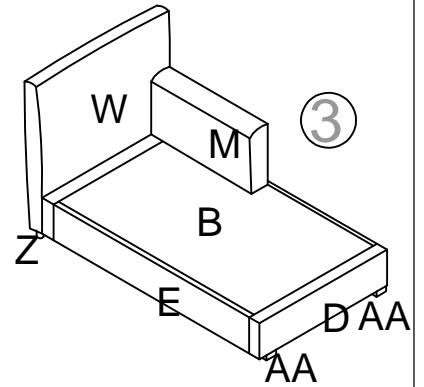
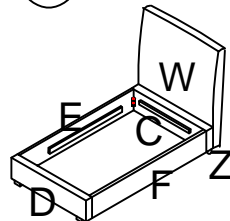

3

### STEP 7

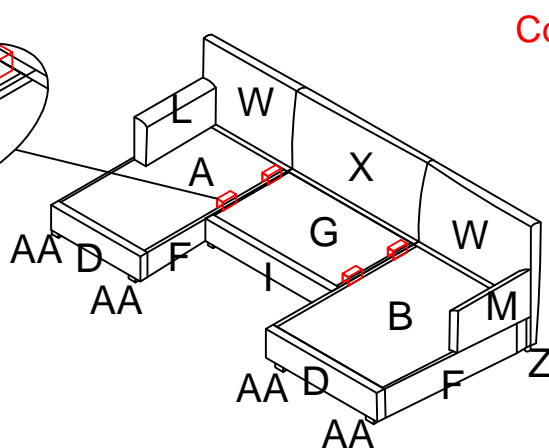
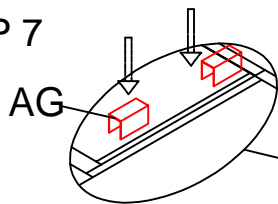

Connecting sofa with hook.

## STEP 8

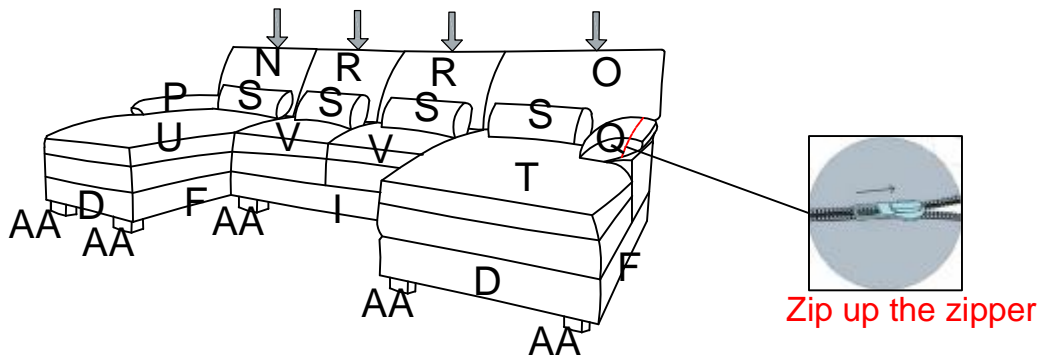

## STEP 9

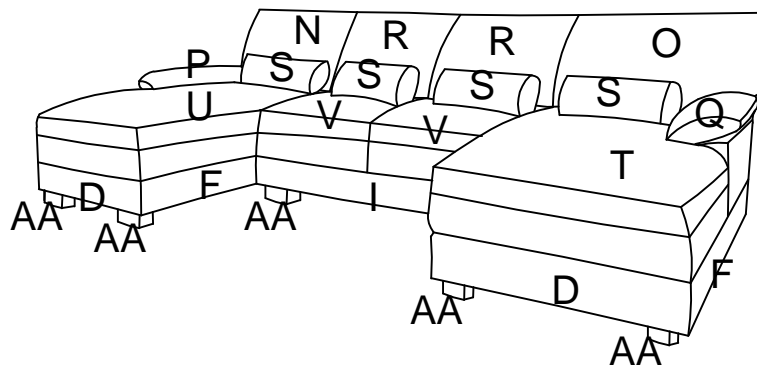

### Notice:

Thank you for purchasing this quality product. Be sure to check all the packing material carefully for small parts, which may have come loose inside the carton during shipment. Identify and count all parts and compare with Part List on Page 1. This sofa is covered by 1-year Limited Warranty for Manufacturing Defects. Please read this Warranty Information carefully for your benefit. This warranty is for manufacturing defects.

### Warranty Information

This warranty is for manufacturing defects only and does NOT cover normal wear & tear or damages resulting from misuse.

### Warranty Details.

1. Your sofa's 1-year Limited Warranty for Manufacturing Defects starts on the date of purchase. No warranty will be honored without an original sales receipt. The warranty and financial responsibility of the manufacturer applies only to the products themselves.
2. Manufacturing defects may include circumstances where the product is broken under normal use and hence cannot provide proper support. In the event of a manufacturing defect found in your sofa, please stop using it immediately and contact the authorized seller on Amazon.
3. This warranty applies only if the product has been used properly by consumers who purchase it from authorized sellers as a new product. Proper use is defined by but not limited to level surface where all legs touch the floor with an equal distribution of weight and no out-of-the-ordinary abuse by the consumer. This warranty does not constitute agreement to replace other parts.
4. If this sofa fails to perform as advertised due to manufacturing defects, the manufacturer will repair or replace at its discretion reserves the right to substitute comparable materials or models and does not guarantee that the replacement part will match existing pieces.
5. In the event the product needs to be inspected by the manufacturer to determine a warranty claim, transportation and removal cost will be borne by the consumer.