

WARNING!!

Children have died from furniture tipover. Tip restraints have been included with this product; you must install the tip restraints according to these instructions in order to minimize the risk of furniture tipping. If you have any questions about this product or the tip restraint, please send us an email at

tip_restraint_help@Noblehousefurniture.com

NEVER allow children to climb or hang on furniture, including drawers or cabinet doors.

In addition to installing the restrains , to help prevent tip-over

1. **NEVER** put a TV or other heavy objects on top of this product".
2. **Do not** stand on the product.

⚠ WARNING	
	<p>Children have died from furniture tipover. To reduce the risk of furniture tipover.</p> <ul style="list-style-type: none">• ALWAYS install tipover restraint provided.• NEVER put a TV on this product.• NEVER allow children to stand, climb or hang on drawers, doors, or shelves.• NEVER open more than one drawer at a time.• Place heaviest items on the lowest drawers.• Do not defeat or remove the drawer interlock system. <p><i>This is a permanent lable Do not remove</i></p>
	



Assembly Instructions





Caution : You must read this before you proceed

END TABLE

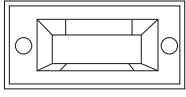

Hardware

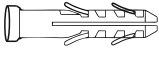
Label	Picture	Description	QTY
①		Screwdriver (not provided)	1
②		Knob	3

③		Power Drill (not provided)	1
④		Bracket	2
⑤		Wall Plug Screw(M20mmx5mm)	4
⑥		Wall Plug(40mmx5mm)	4
⑦		Tipover Restraint Strap	2
⑧		Hammer(not provided)	1

Assembly Preparation

Before Beginning Assembly:

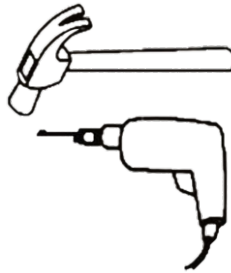
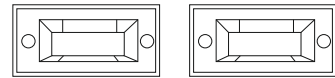
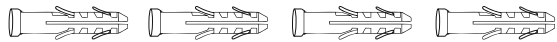
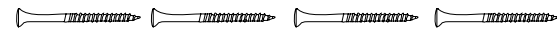

- Read instructions, cover to cover.



- Have 2 adults on hand for assembly.



- Do not assemble on flooring or carpet.

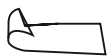

- Assemble on a clean non-marring surface (packing foam).



- Save all packaging until finished.

Assembly Steps

Overview

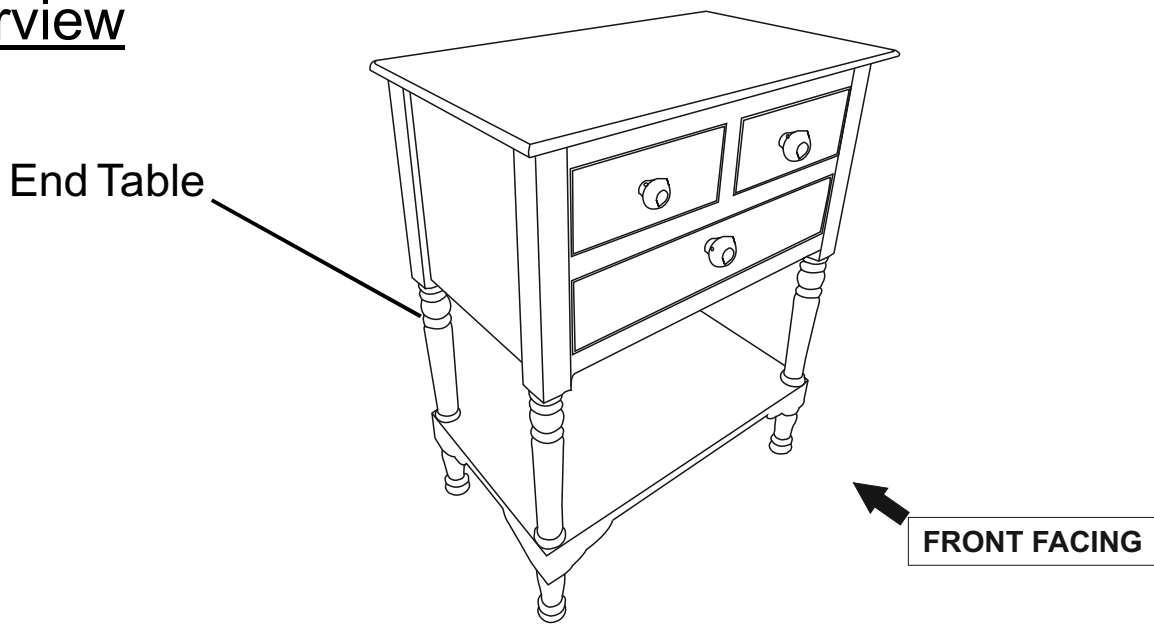

This End Table has multiple parts and may require up to 30 minutes to assemble. To give you an overview of the End Table parts, the above picture is to help you put the various parts into perspective.

Please read through the instructions herebelow to familiarise the parts and steps before assembly.

Step 1

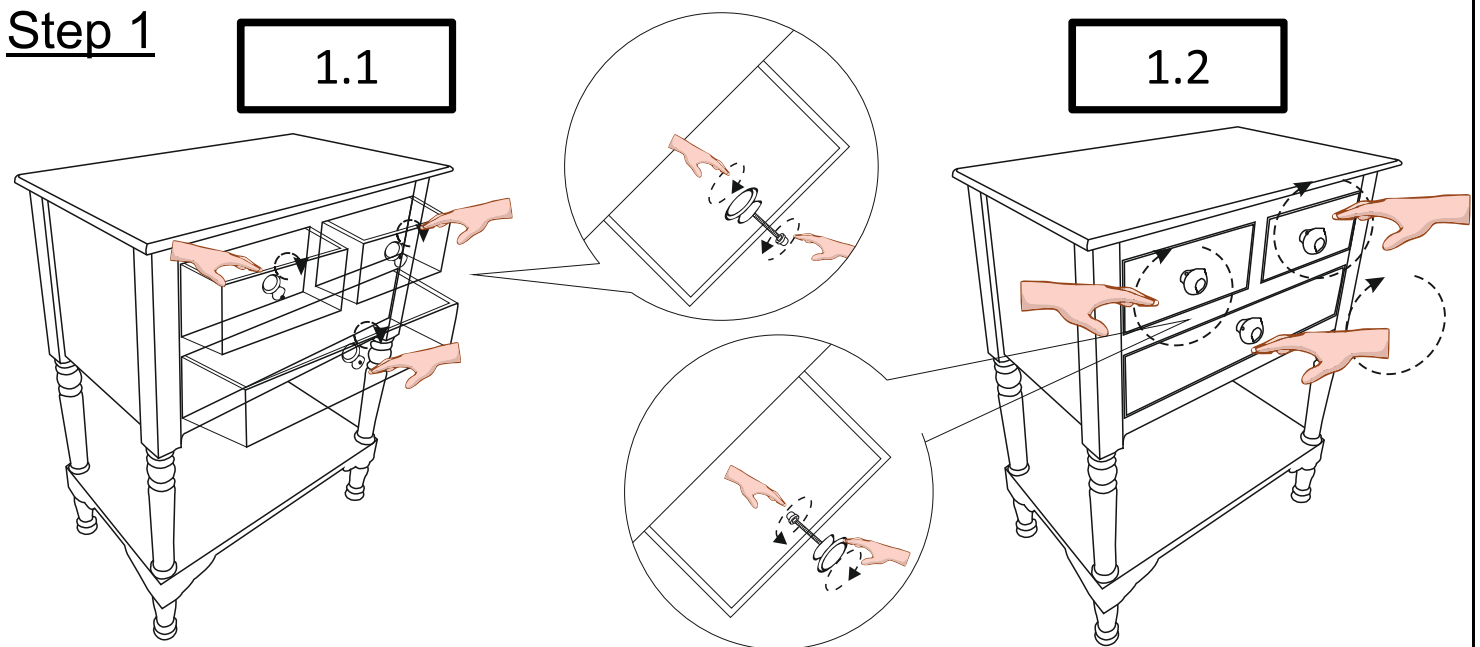

With help of your adult partner, carefully stand the End Table.

1.1 Put out the drawers and deassemble the Knob(②) with the help of hand and rotate towards the left side.

1.2 Install the Knob(②) on the drawers with the help of hand towards the right side as pictured above.

Tipover Restraint Device Installation Instructions



WARNING

Serious or fatal crushing injuries can occur from tipping furniture. To help prevent tip-over: ALWAYS secure this furniture to the wall using Tipover Restraint Device.

See product instructions for more ways to help prevent furniture tip-over.

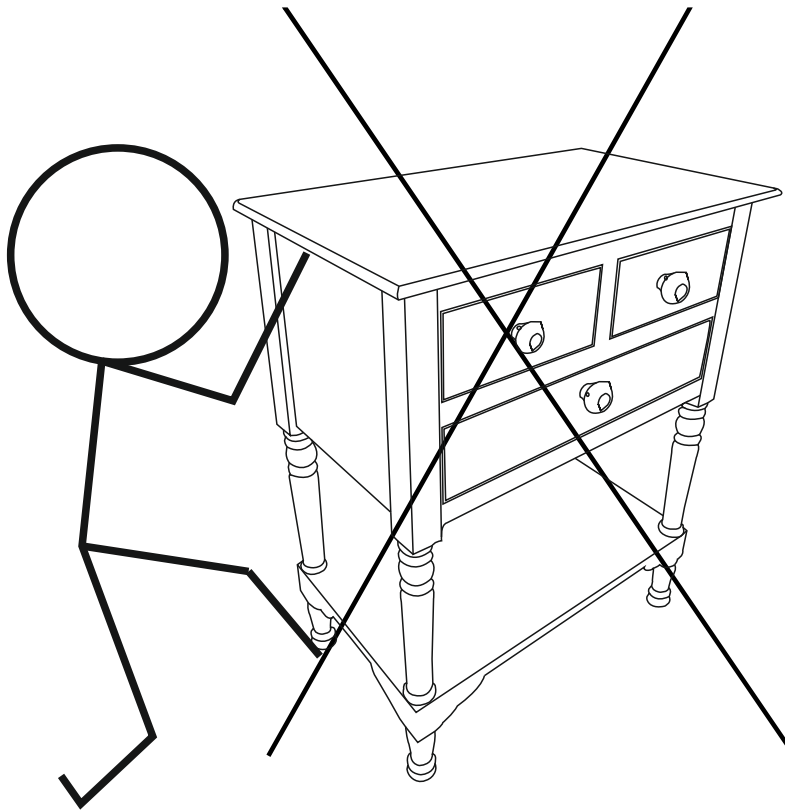

Usage For Tipover Restraint Device:

To secure End Table against wall, attach two Brackets (④) on wall and product, use Tipover Restraint Strap (⑦) to connect the Brackets (④).

Step 2

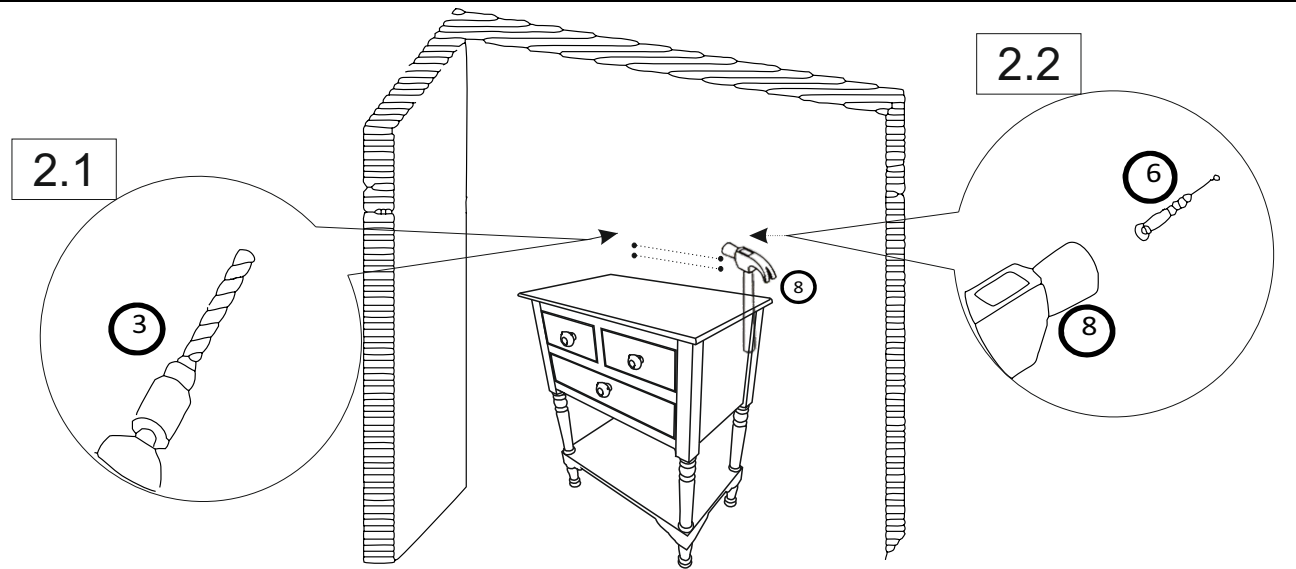

2.1) Drill two holes on wall at same height as Brackets (④) on End Table with Power Drill (③).

You can mark these points in two ways as below:

1) Move the End Table back to the wall. Mark two points same height as End Table on the wall.

Note: The Brackets need to be secured to solid, load bearing surface. Please use a Stud Finder(not supplied) if needed to locate the Wall Frame.

2) Measure the height of the Brackets (④) with ruler/measuring tape and mark on wall to keep them accurate and same height.

2.2) Insert Wall Plugs (⑥) into drilled holes on wall with Hammer (⑧).

Step 3

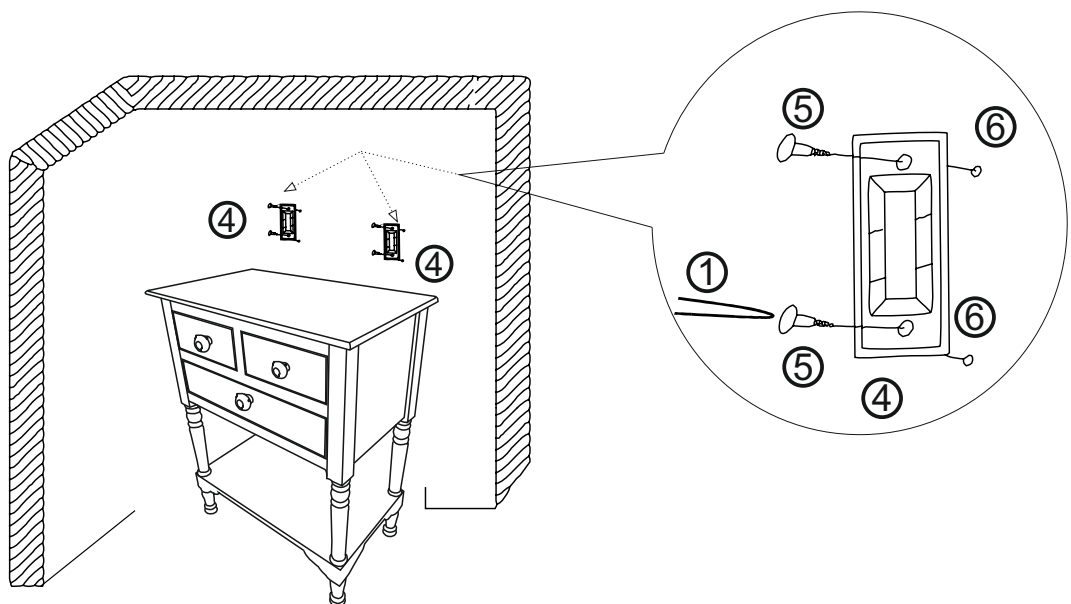

Attach Brackets (④) to Wall Plugs (⑥) using Wall Plug Screws (⑤) with Screwdriver (①).

Step 4

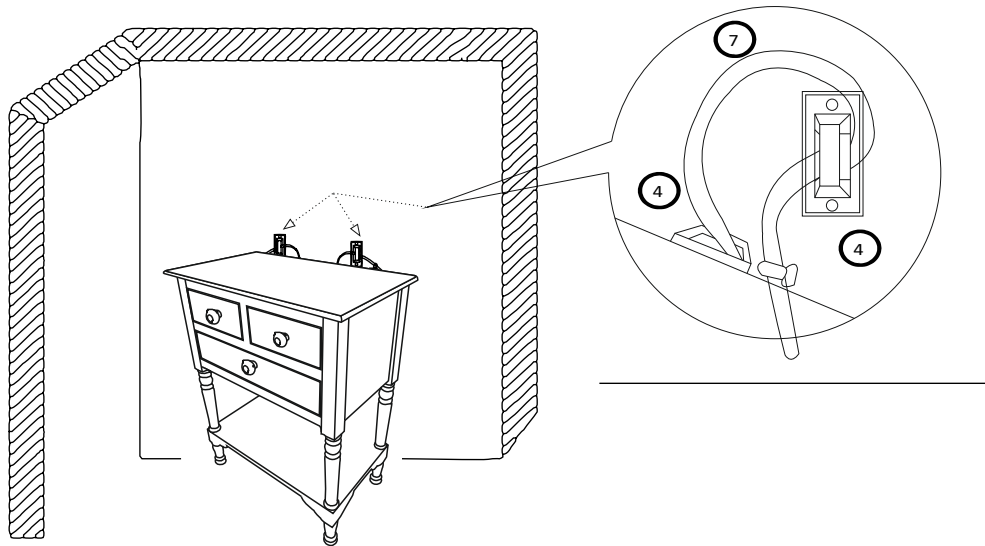











Move End Table to the wall.

Pull the Tipover Restraint Straps (⑦) through the Brackets (④) on the wall and End Table one by one, and pull the Tipover Restraint Straps (⑦) tight.

This End Table is now ready to use.

Caution: This End Table can only be used on flat, level surface.

Care & Maintenance

- ✓  ● Furniture may scratch floors. We recommend using furniture pads to protect your floors.
- ⊘  ● Do not put hot items directly on furniture surface
- ⊘  ● Do not clean furniture with harsh cleansers or polish.
- ⊘  ● Do not place furniture under direct sunlight.
- ⊘  ● Do not place furniture near heating or cooling vents.
- ⊘  ● Do not write on furniture without a passed barner to protect the surface.
- ⊘  ● Do not place furniture outside. for indoor use only.
- ⊘  ● Not for commercial use. for residential use only.
- ⊘  ● Stains may be removed with mild soap solution and damp cloth.
- ⊘  ● Children should not climb or jump on the furniture.
- ✓  ● Dust and pick - up shills using a clean, non-colored, lint-free cloth.