

INSTRUKCJA MONTAŻU
INSTRUCTIONS DE MONTAGE
ASSEMBLING INSTRUCTIONS
ISTRUZIONI DI MONTAGGIO
MONTAGEANLEITUNG
INSTRUÇÕES DE MONTAGEM
MANUAL DE MONTAJE

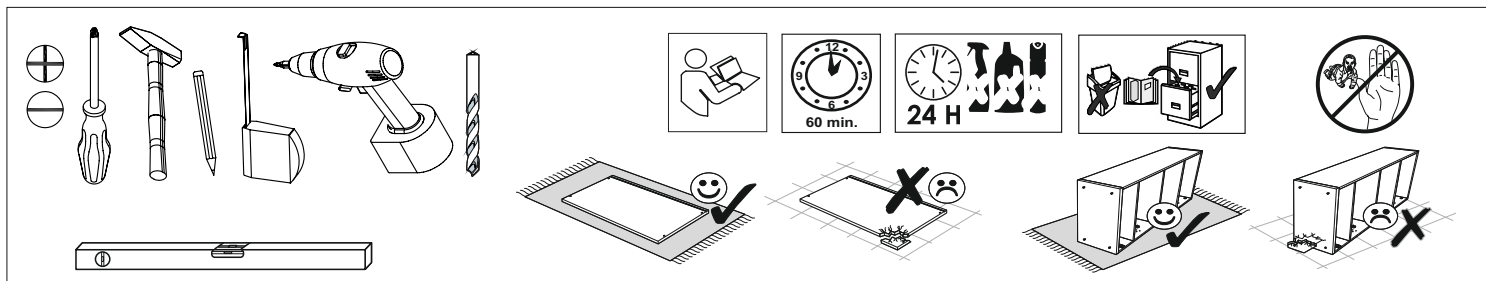

Accessories/Accessories/Accessori/Zubehör/Acessórios/Accessorios

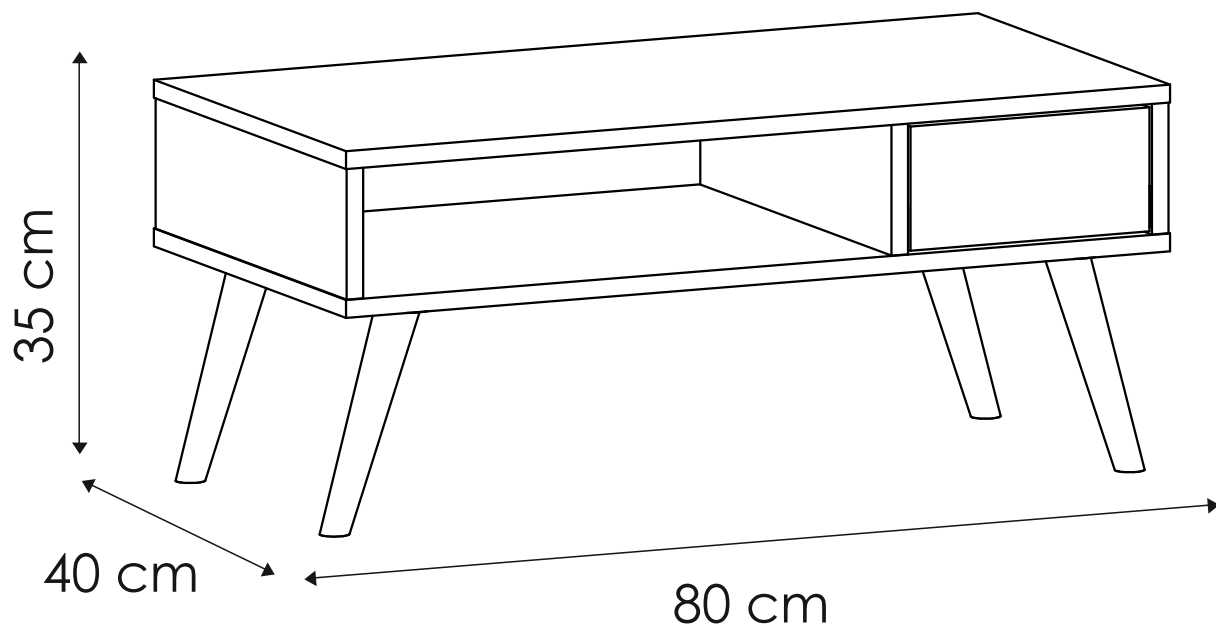

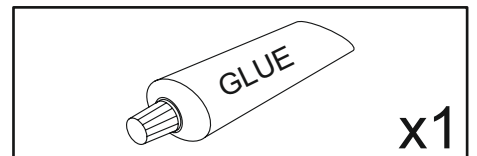
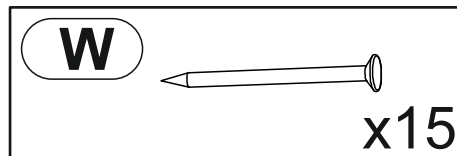
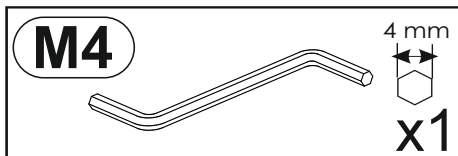
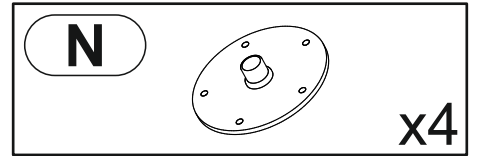
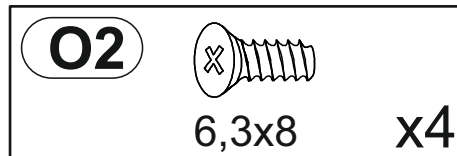
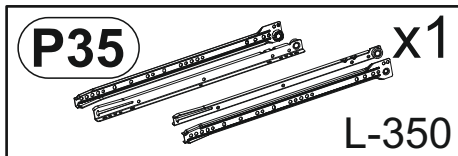
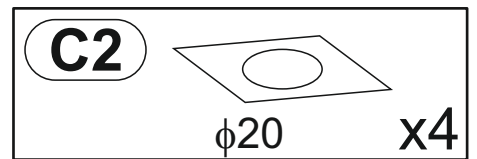
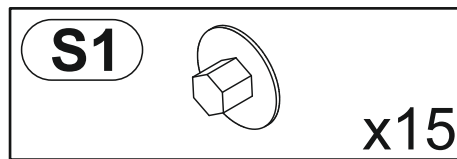
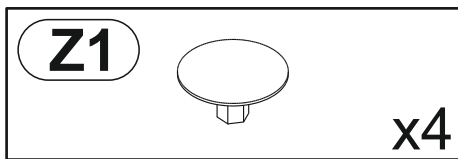
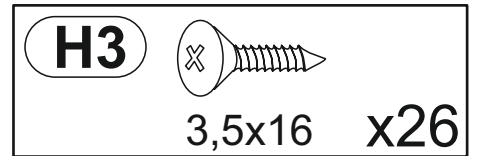
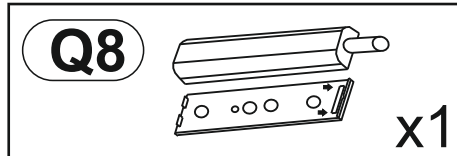
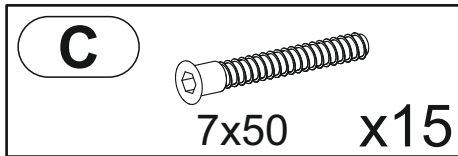
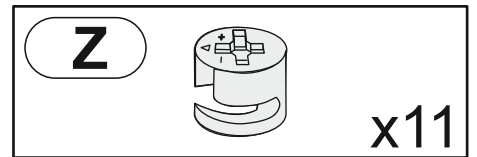
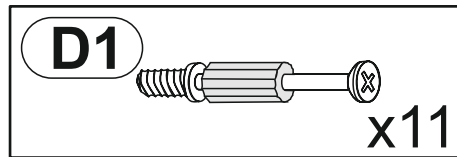
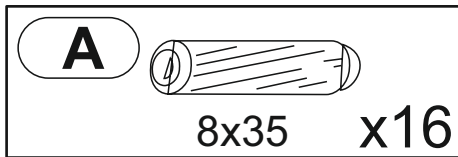
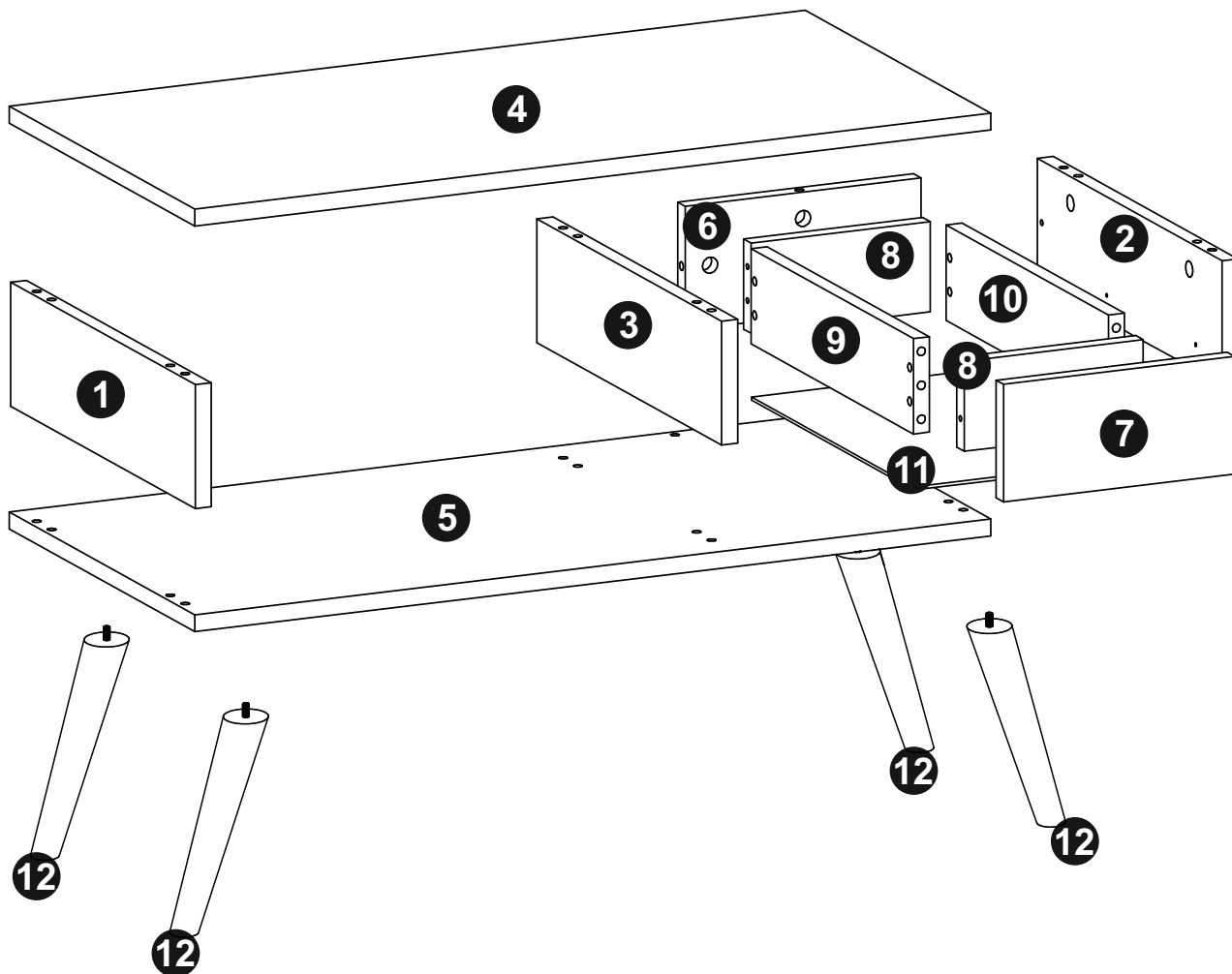

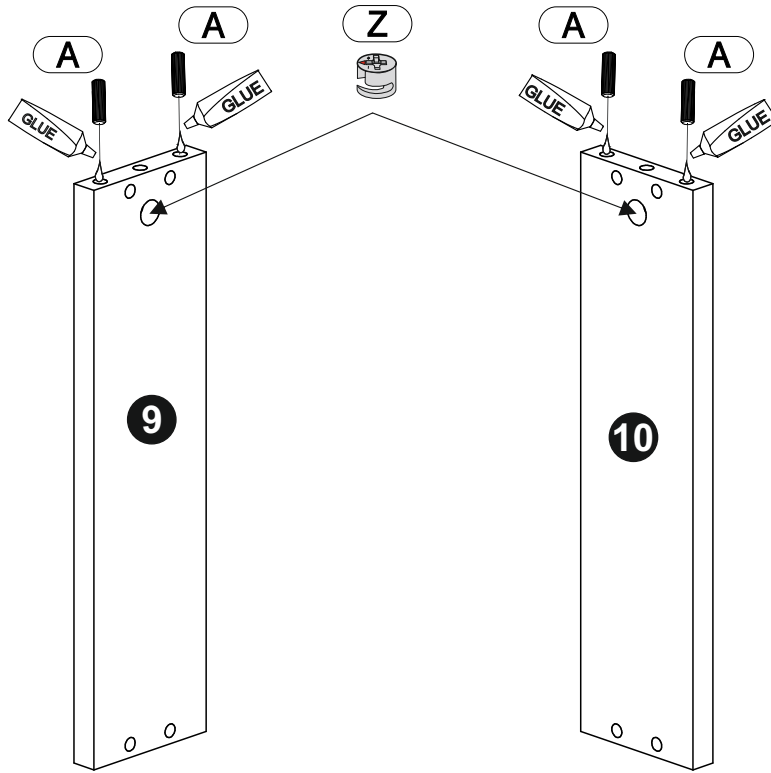

- ①** 117 mm x 398 mm x 16 mm - 1 pc.
- ②** 117 mm x 398 mm x 16 mm - 1 pc.
- ③** 117 mm x 398 mm x 16 mm - 1 pc.
- ④** 800 mm x 400 mm x 16 mm - 1 pc.
- ⑤** 800 mm x 400 mm x 16 mm - 1 pc.
- ⑥** 117 mm x 237 mm x 16 mm - 1 pc.
- ⑦** 232 mm x 111 mm x 16 mm - 1 pc.
- ⑧** 180 mm x 85 mm x 16 mm - 2 pcs
- ⑨** 350 mm x 90 mm x 16 mm - 1 pc.
- ⑩** 350 mm x 90 mm x 16 mm - 1 pc.
- ⑪** 349 mm x 211 mm x 3 mm - 1 pcs
- ⑫** 205 mm x 40 mm x 20 mm - 4 pcs

1

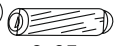

- A  8x35 x4
- Z  x2
- GLUE  x1

2

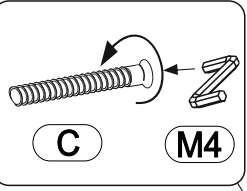

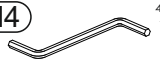
- C  7x50 x8
- M4  4 mm x1

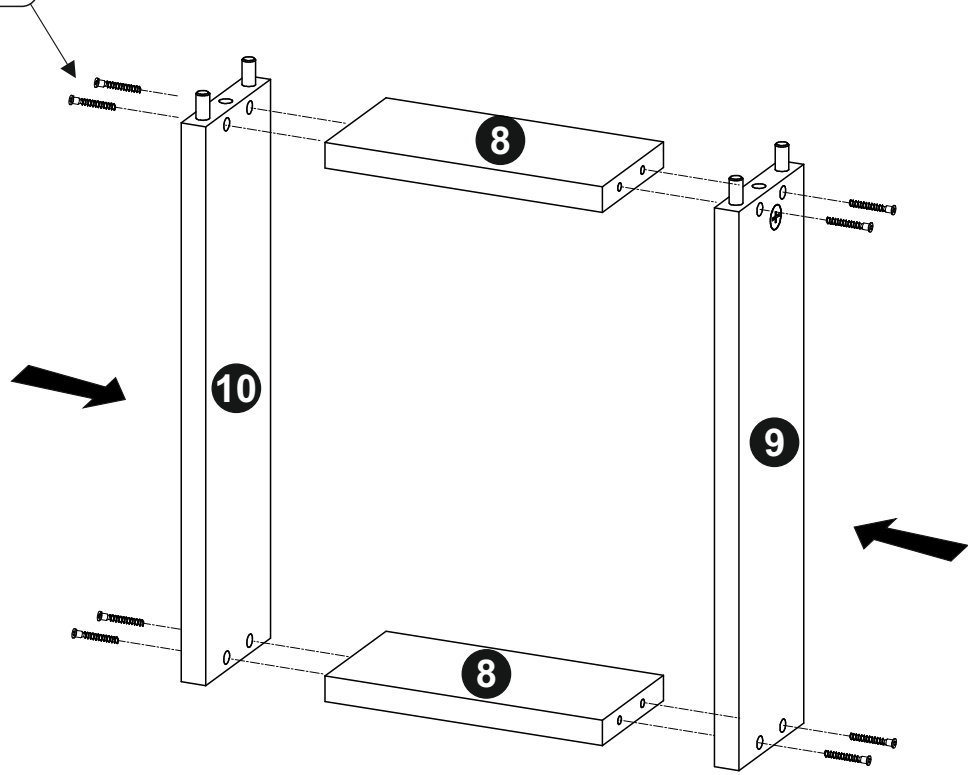
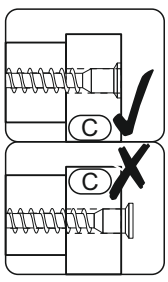

3

W  x15

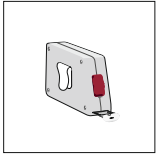

a = b

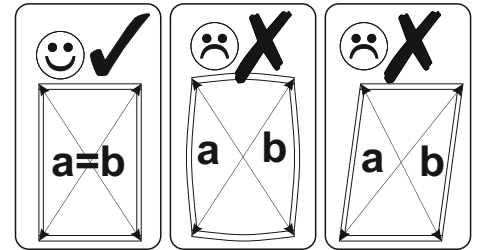
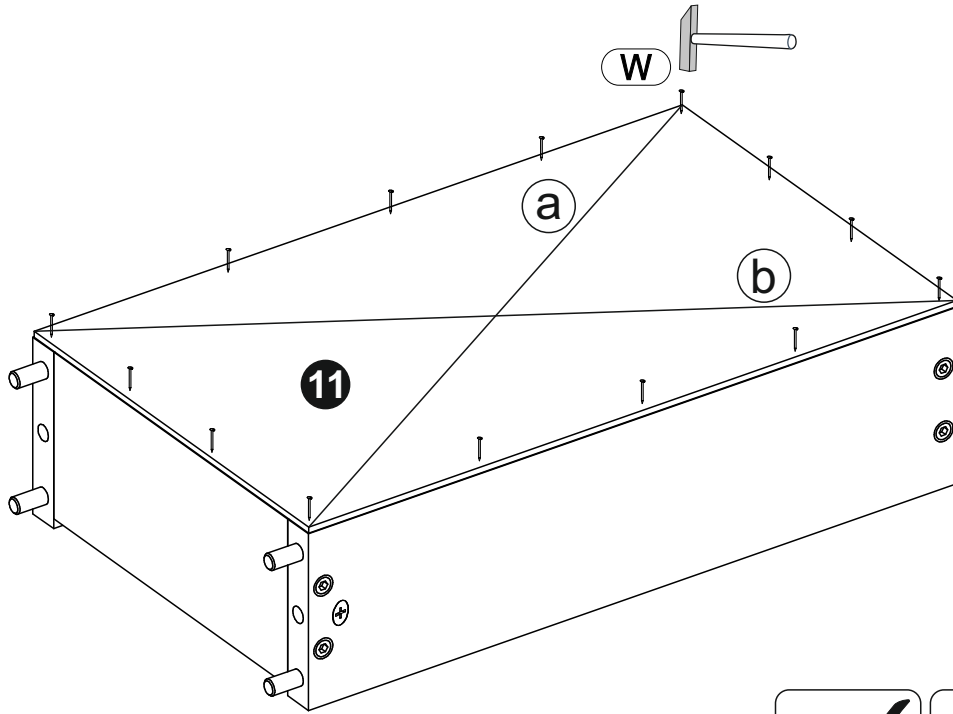

4

D1  x2

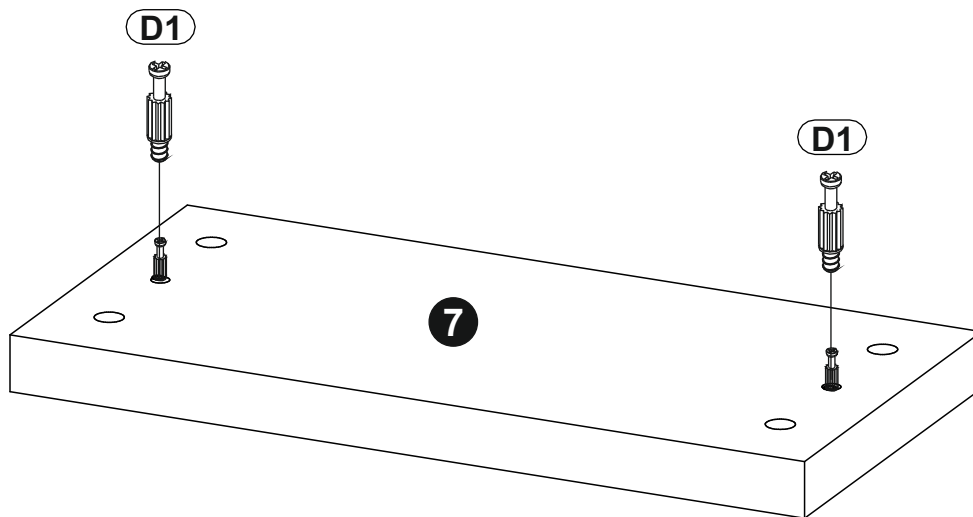
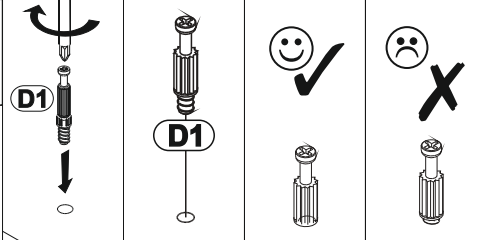

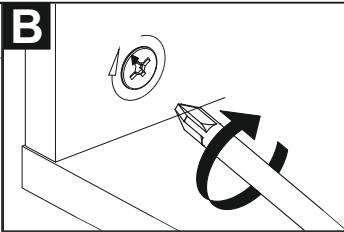
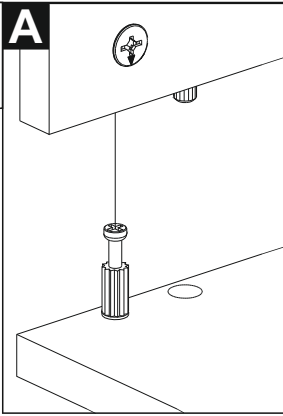

5

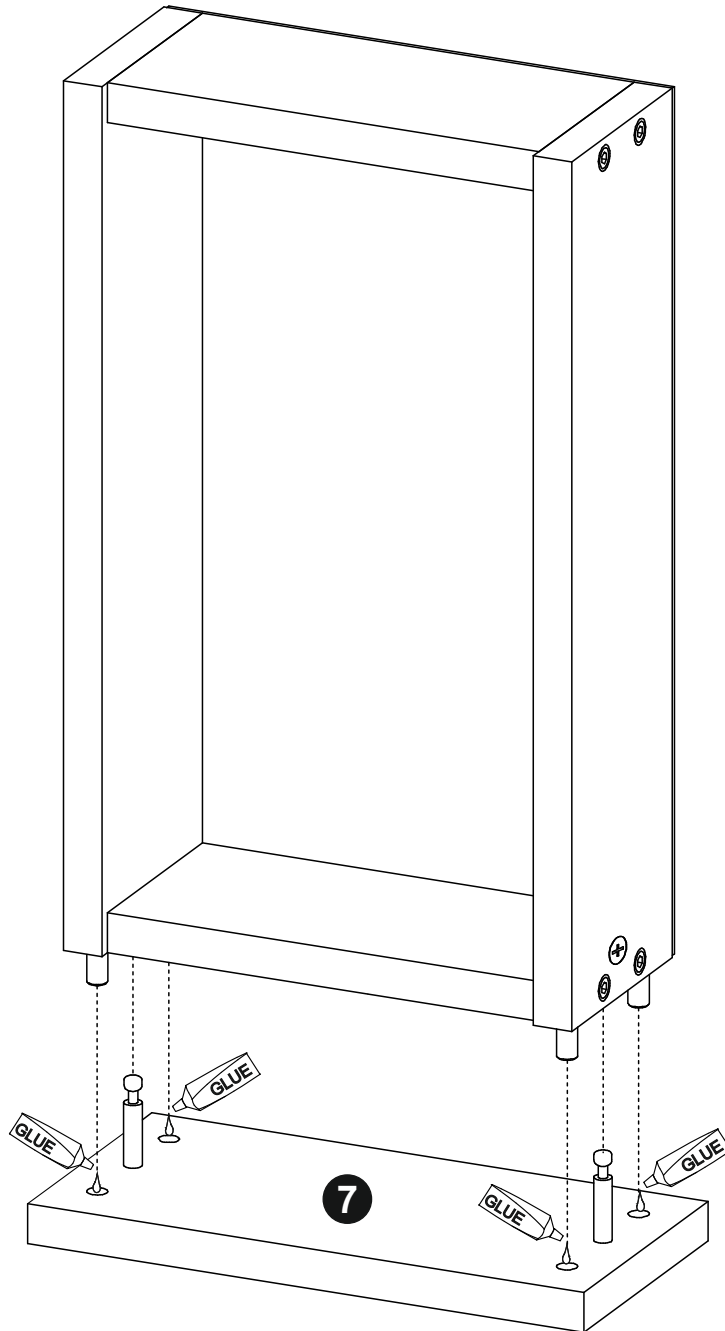

x1



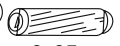

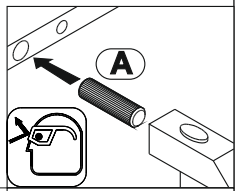
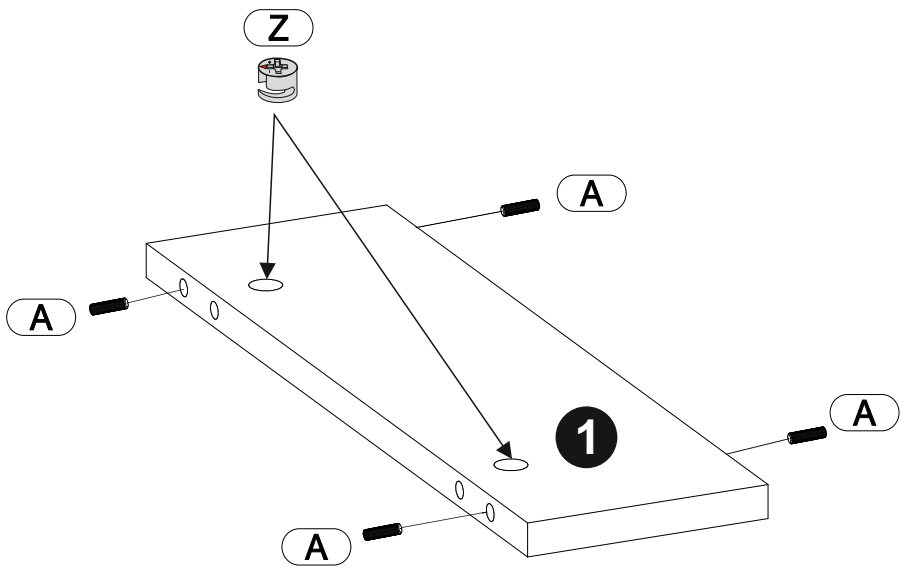

6

A		8x35	x4
Z			x2



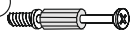

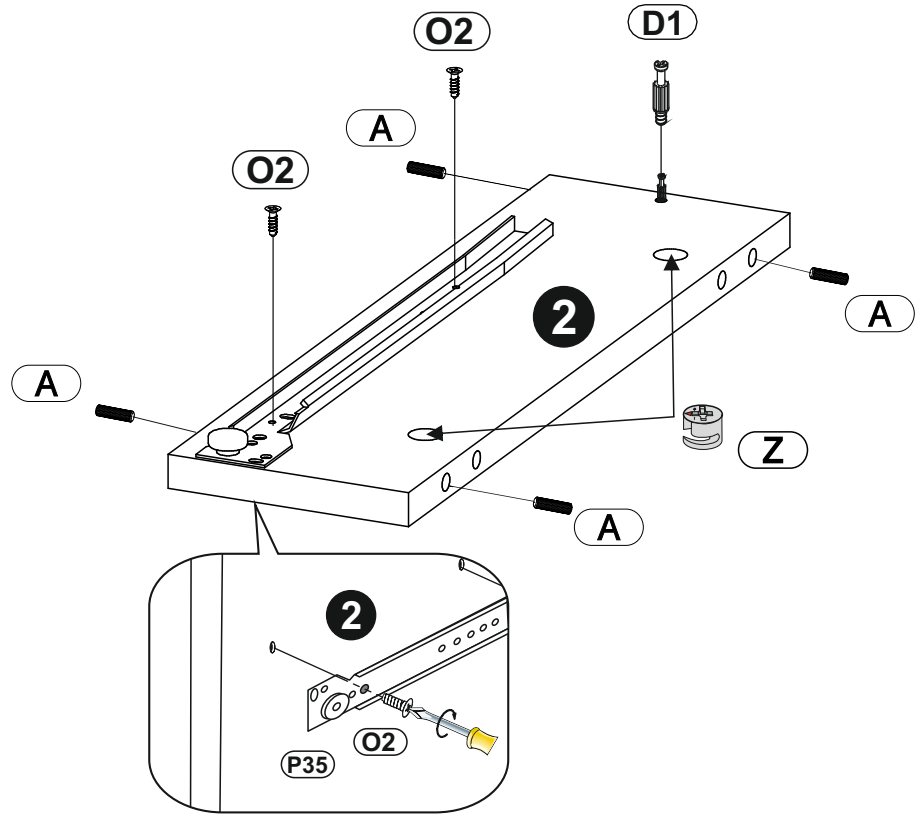

7

A		8x35	x4
Z			x2
D1			x1
O2		6,3x8	x2
P35			x1

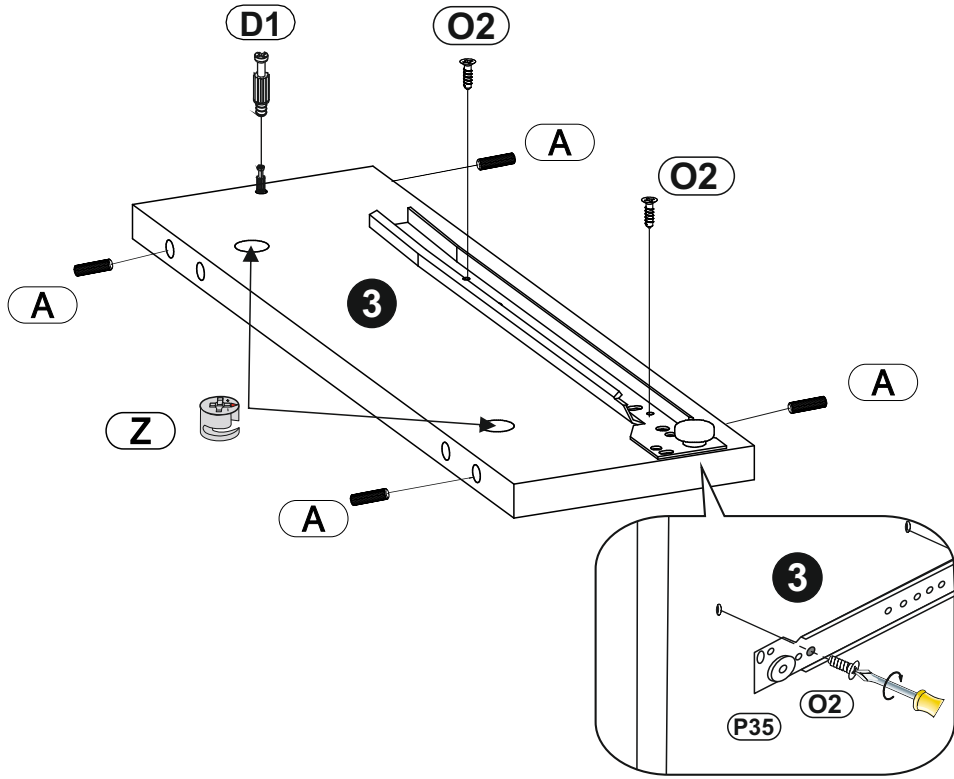

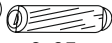

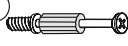
8



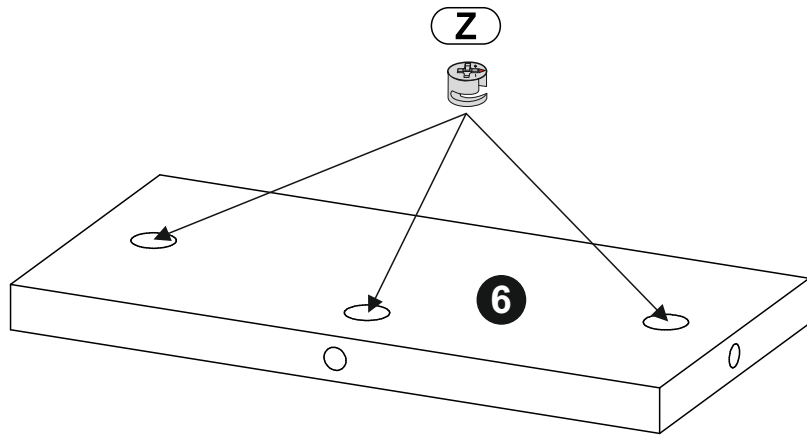

A		8x35	x4
Z			x2
D1			x1
O2		6,3x8	x2
P35		L-350	x1

9



Z			x3
----------	---	--	----

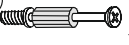

10

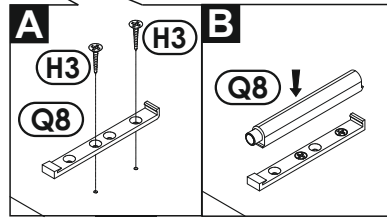
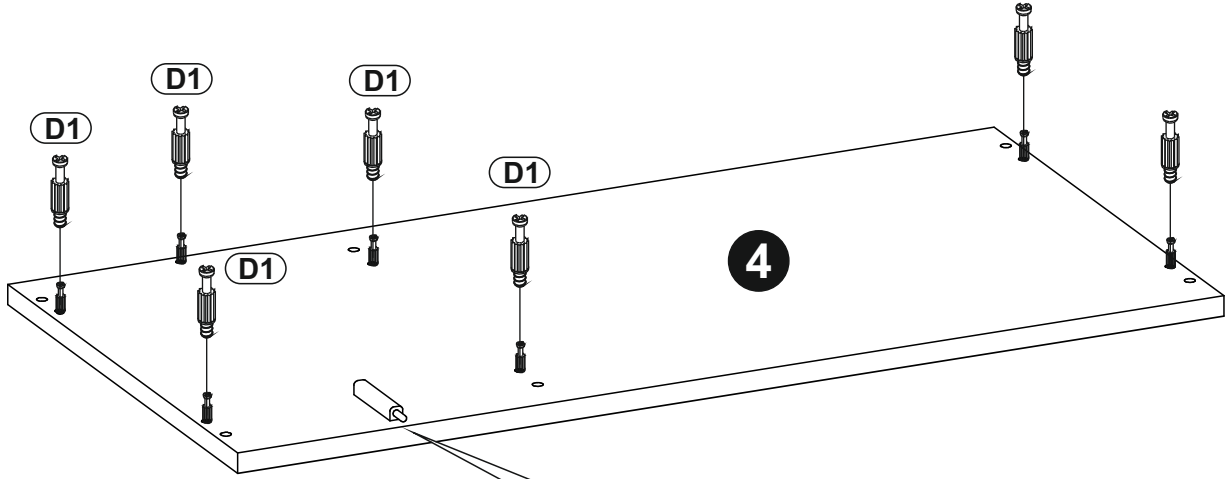
- D1**  x7
- Q8**  x1
- H3**  3,5x16 x2

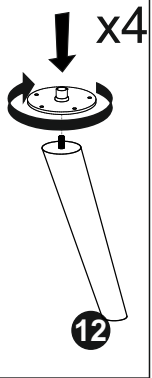

11



- N**  x4
- H3**  3,5x16 x20
- C2**  φ20 x4

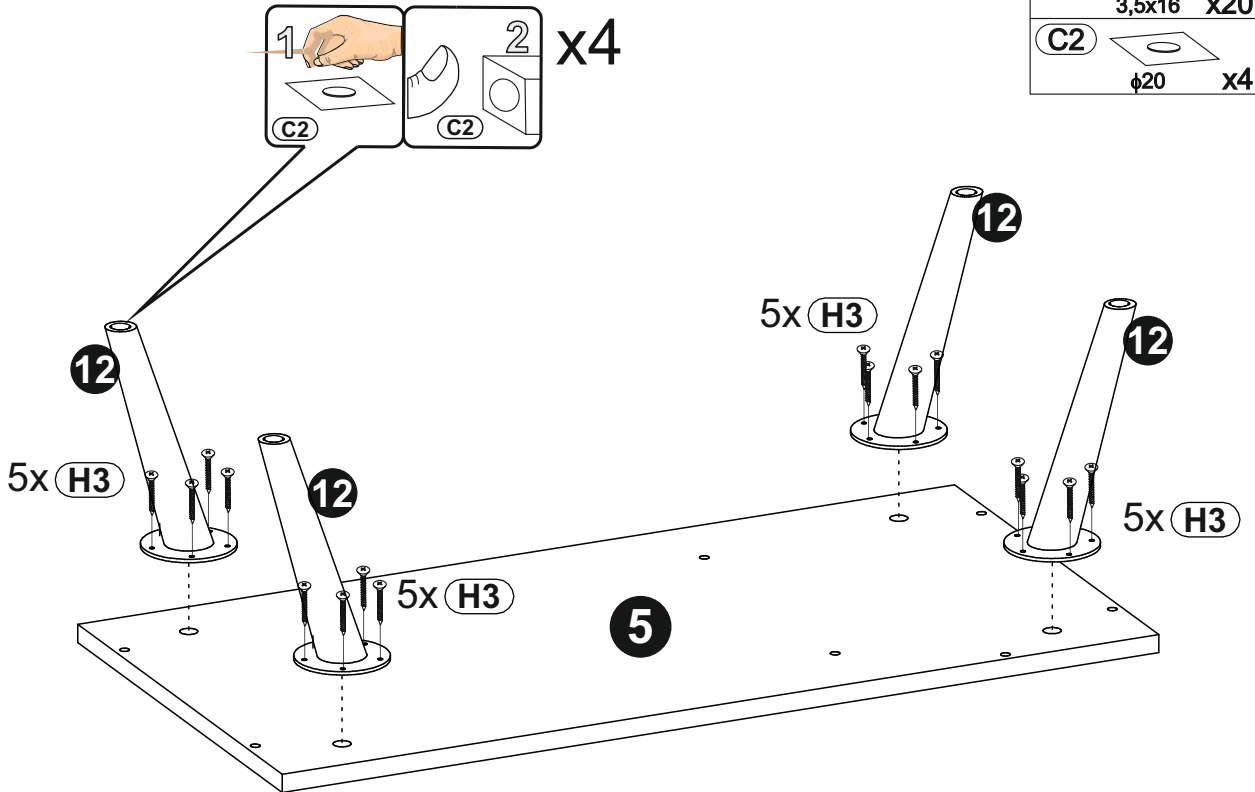

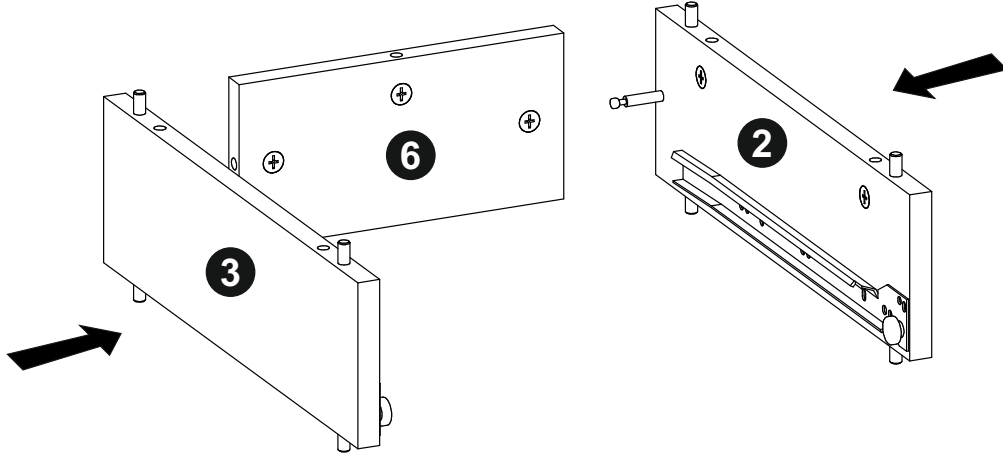
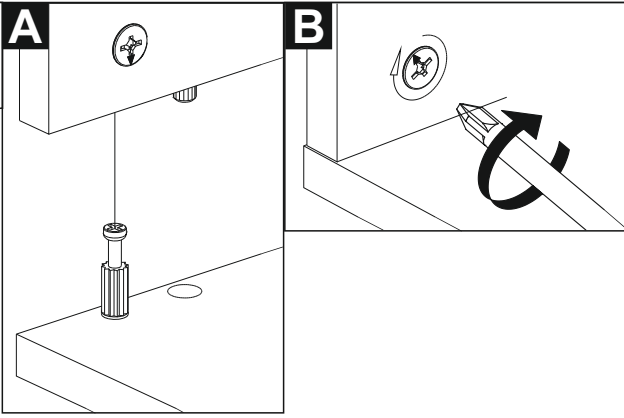

12

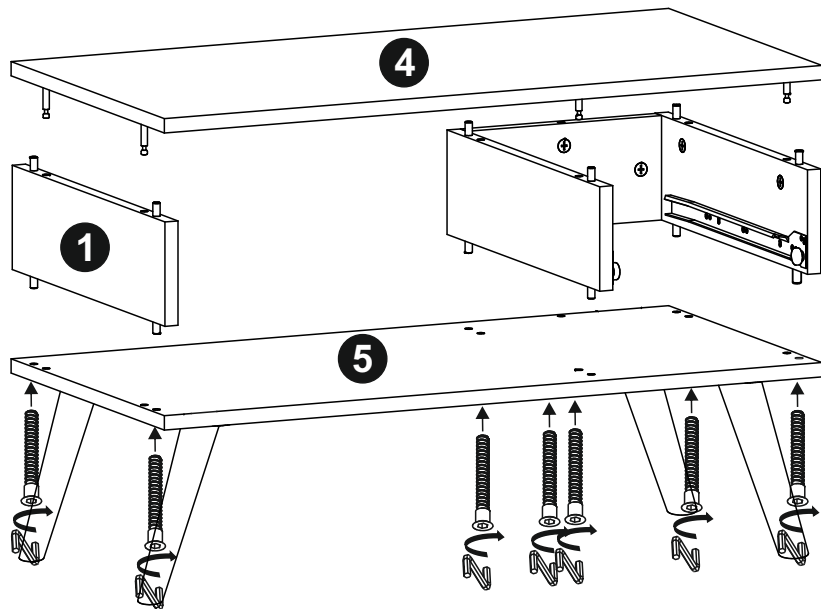
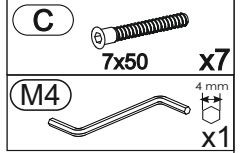
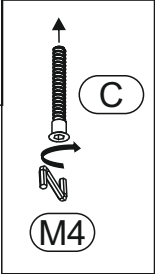

13



14

H3  3,5x16 X4
P35  X1
L-350

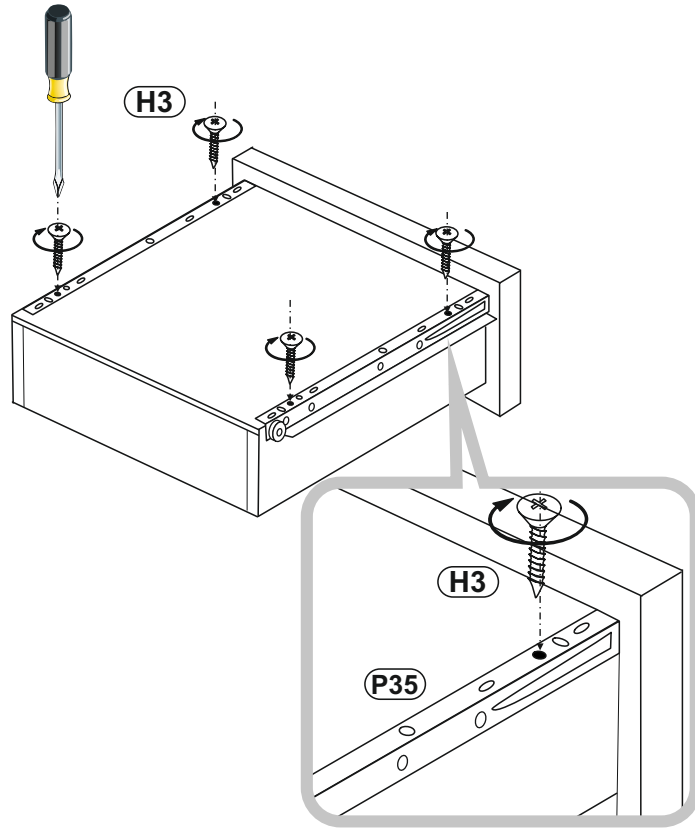

15

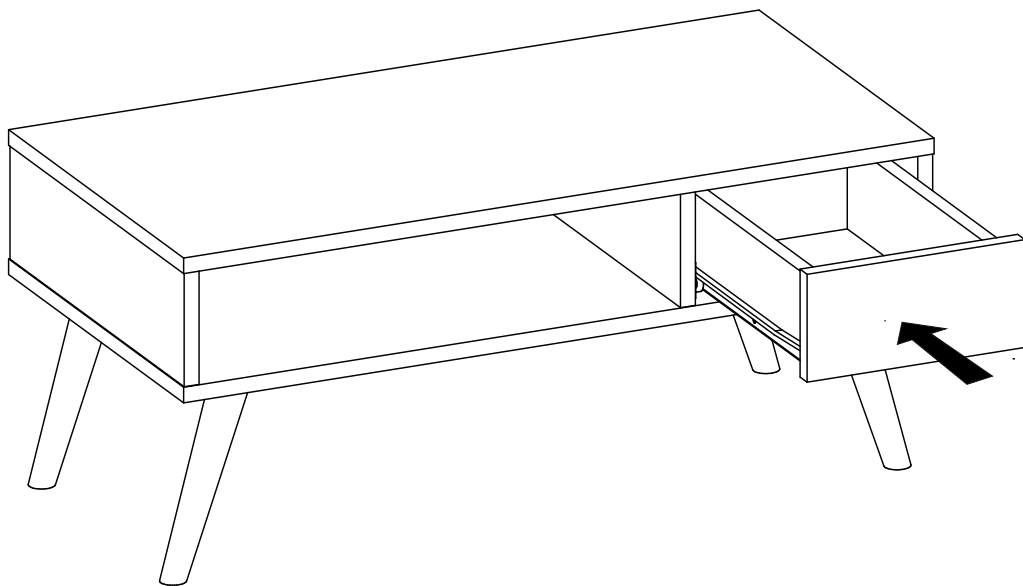
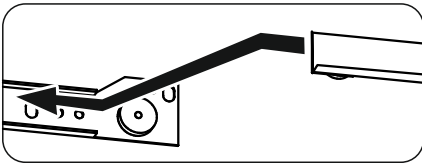

16

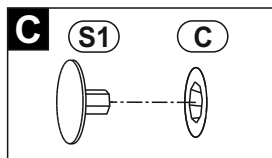
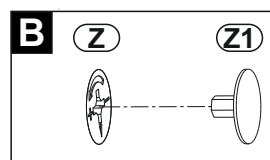
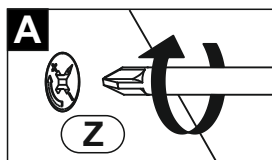

Z1		x4
S1		x15

