

ASSEMBLY INSTRUCTIONS

48"x38"x30" LOFT DINING TABLE

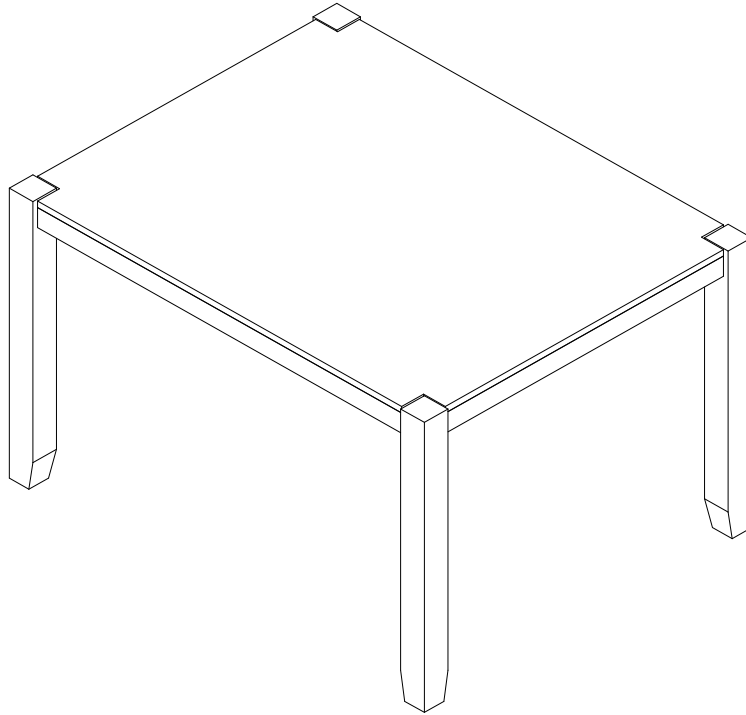

REPLACEMENT PARTS

Please do not contact the company purchased from as we can help you faster.

Order replacement parts and hardware

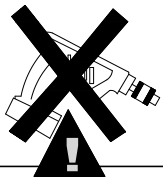

- . Use of power tool to assemble this product will invalidate any claim and damage this product making it unsafe!!!
- . Please assemble on a clean soft surface to avoid damage.

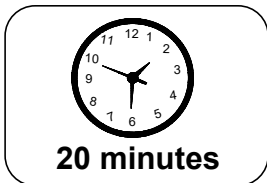
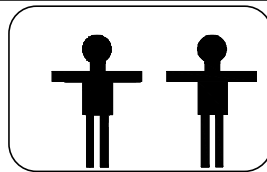

Tool Included

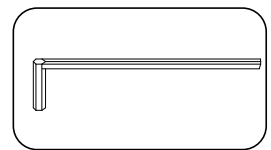

Part List-48"x38"x30" Dining Table

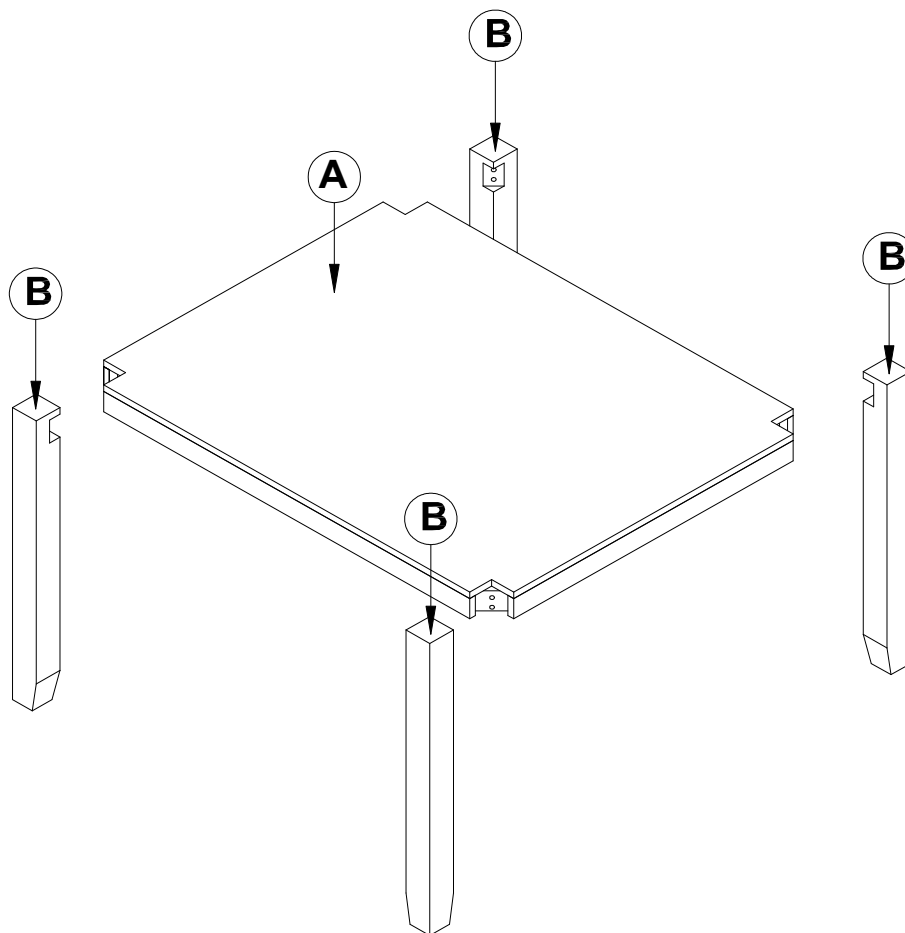

Identifying the hardware-Identify the hardware using the illustrations below.

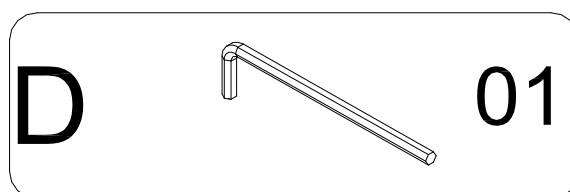

STEP 1

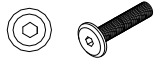
C  **08**
M6X60mm

D  **01**

