

WARRANTY

We strive to offer high-quality products, and we also try our best to satisfy each and every customer that orders from us with product or service as needed. We provide 30 days warranty starting from the time you receive the item. Each customer must provide a record of their order such as the order number, or item receipt for any items that are out of the warranty period you may also still receive replacement parts by purchasing them with our company if they are available.

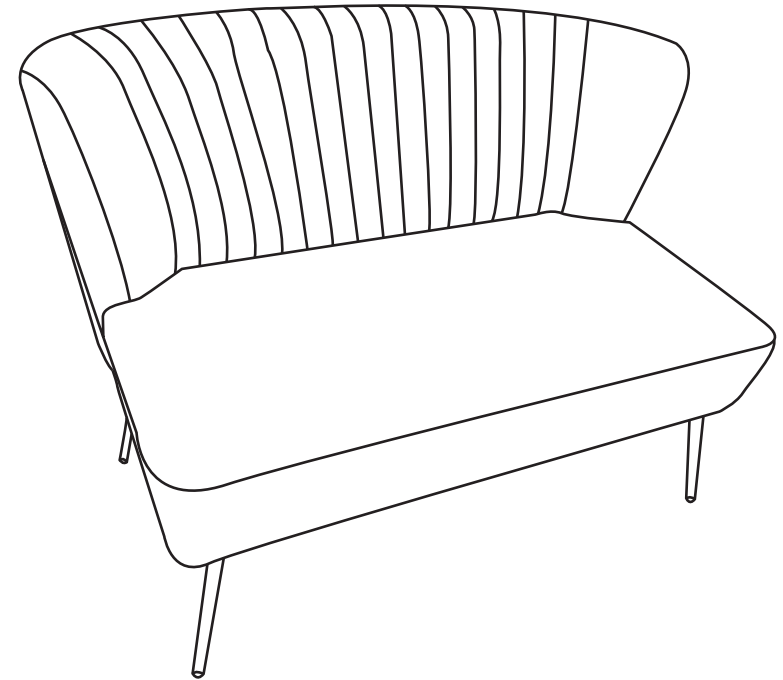

NOTE:

This brochure contains IMPORTANT safety info. Please read and keep for future reference.

MAINTENANCE AND WARNING

- Keep furniture away from heat.
- Do not clean furniture with harsh cleansers or polish. Do not use detergents, Solvents, abrasives, spray packs or leather cleaner. Use non-color mild soap with warm water clean spills(Mix 1:10 soap to water)
- Do not place furniture under direct sunlight, material will possibly fade over time.
- Do not use on site dry Cleaning machine.
- Children should not climb or jump on the furniture.
- Do not write on furniture without a padded barrier to protect the surface.
- To obtain the longest lifespan of your outdoor products, avoid exposure to rain or snow, and direct sunshine for long time. Whenever possible cover the product and/or place under patio or awnings.
- Not for commercial use, For residential use only.



Weight Limitation

500LBS

PARTS LIST

Ax1

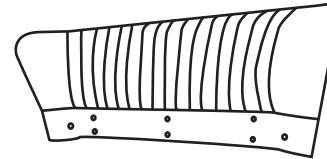

Bx1



Cx4



Estimated Duration Of Assembly

5-10 MINUTES

HARDWARE LIST

Dx8
M8x55mm



Ex12
M6x20mm



Fx8



Gx8



Hx1 M8

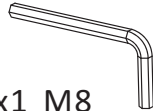

lx1 M6

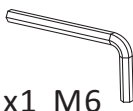

SPARE

Dx1
M8x55mm



Ex1
M6x20mm



Fx1



Gx1



Hx1



Be sure to check all packing material carefully for small parts, which may have come loose inside the carton during shipment.

ASSEMBLY INSTRUCTIONS

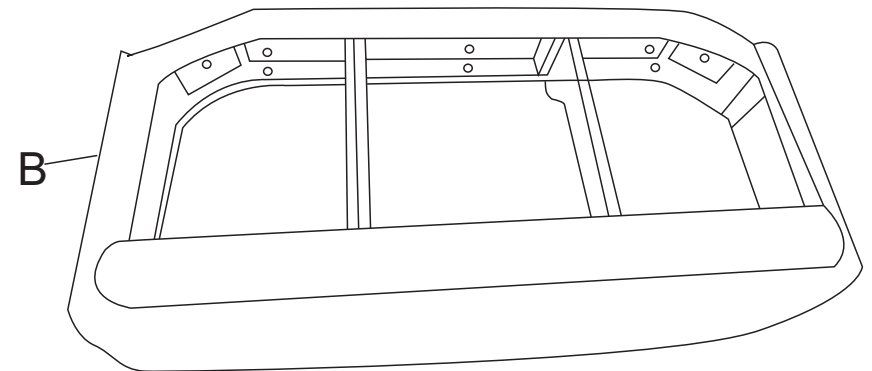
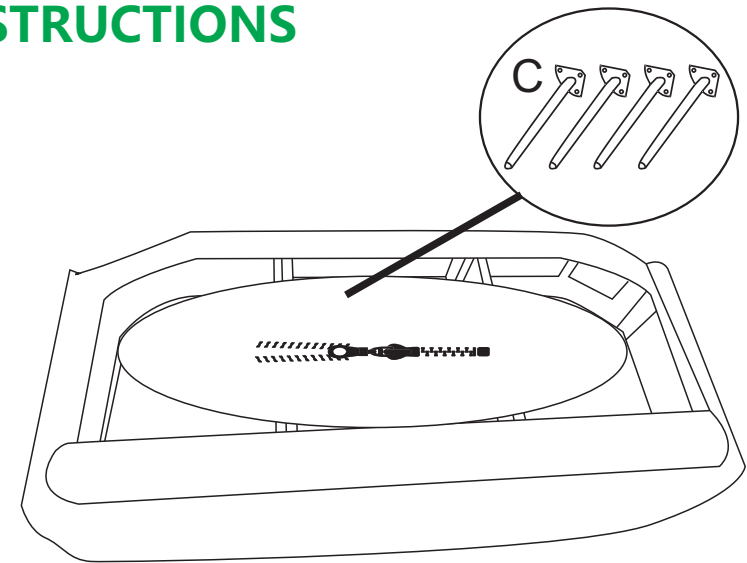

STEP 1 Open the zip on bottom of the seat cushion B under pocket and take out the components. Place the seat cushion B on a clean padded surface.

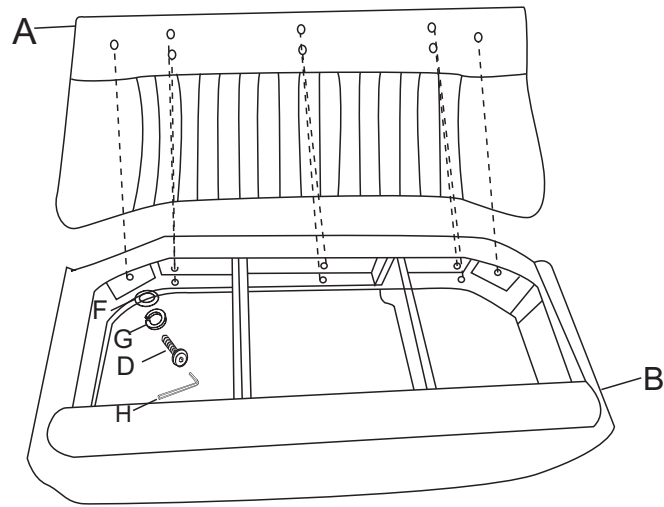

STEP 2 Align hole position on seat cushion B and back A, use bolt D, flat washer F, spring washer G allen wrench H to connect seat and back, Don't fasten any bolt until all bolts connected properly and position aligned correctly.

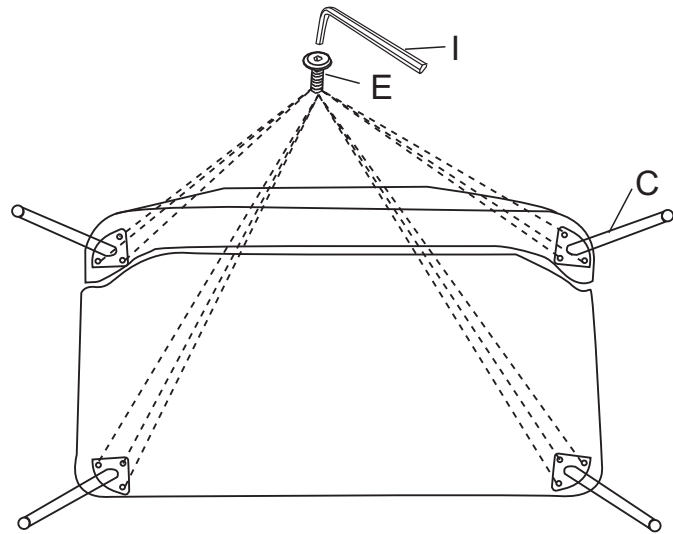

STEP 3 Use bolt E, allen key I to attach legs bottom of the seat cushion and fasten all bolts.

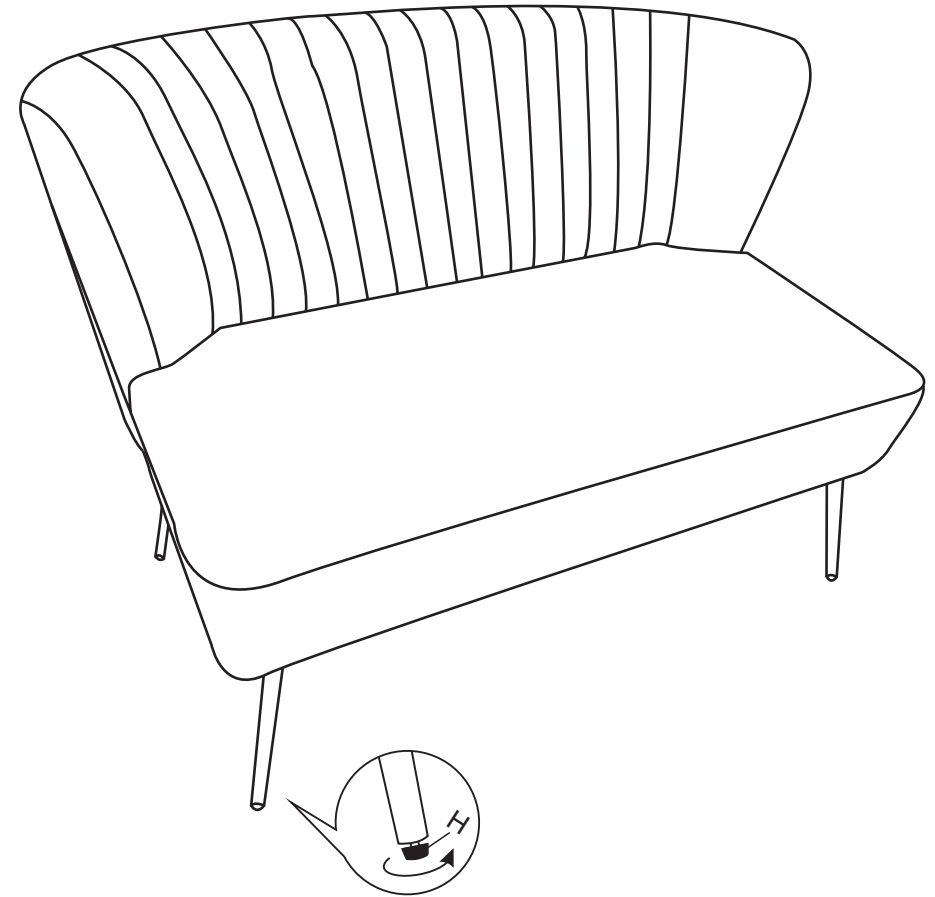

Adjust levelers under legs to set the loveseat level.

STEP 4 Assembly completed.