

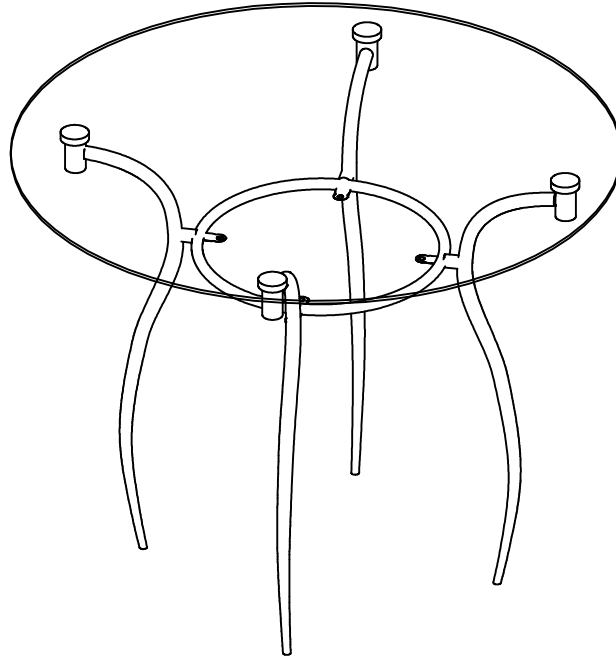







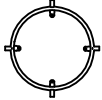

Assembly Instructions

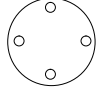

Thank you for purchasing our product!

Please assemble the products with the guidance of this manual instruction.

A		TABLE LEG	4PCS	F		ALLEN WRENCH	1PC
B		TABLE BAR	1PC	G		PLASTIC CAP	4PCS
C		GLASS TOP	1PC	H		HEX NUT	4PCS
D		SMALL GLASS TOP	1PC	I		FLAT WASHER	4PCS
E		BOLT	4PCS	J		LEG BASE	4PCS

STEP 1

INSERT BOLT(E) INTO THE METAL PLATE AS SHOWN BELOW

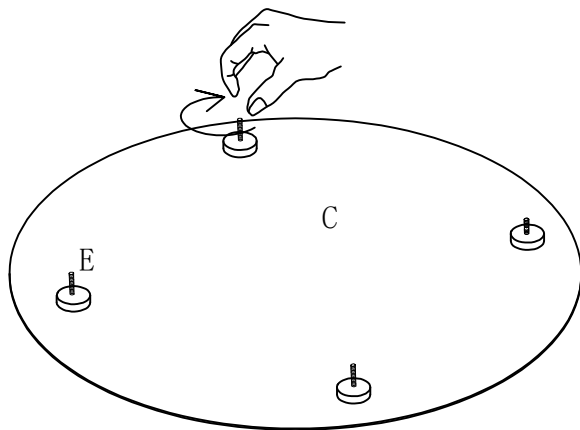

STEP 2

DON'T TIGHTEN THE BOLTS

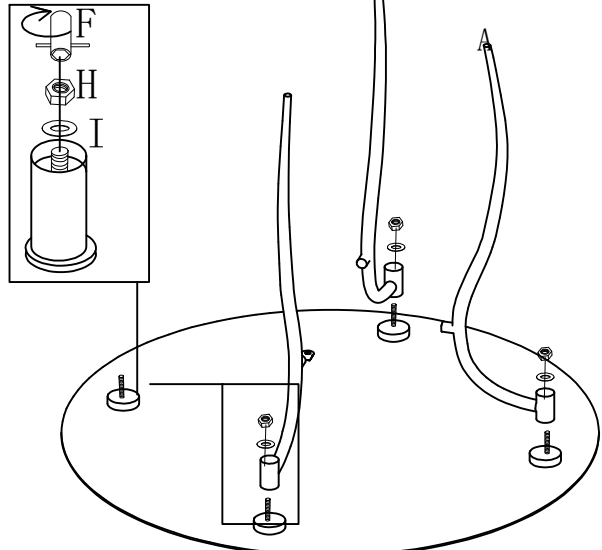

ATTACH TABLE LEG(A) AND TABLE BAR(B) TOGETHER AS SHOWN

STEP 3

ATTACH LEG BASE (J) AS SHOWN

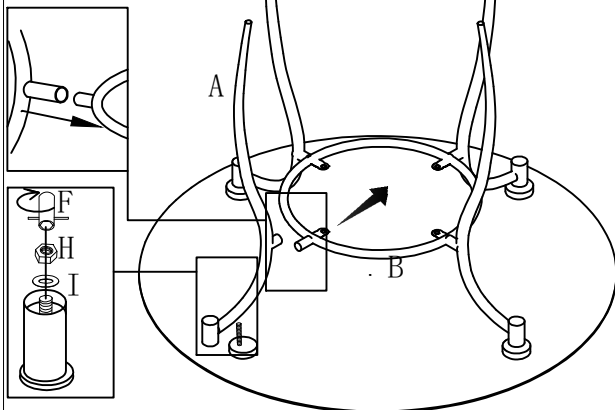

SECURE THE ASSEMBLED LEGS TO THE GLASS TOP(C) BY USING HEX NUT (H) AND FLAT WASHER (I) AS SHOWN TIGHTEN THE BOLTS

STEP 4 INSERT THE PLASTIC CAP(G) ON THE TABLE BAR(B) AND PLACE THE SMALL GLASS TOP(D) ON IT

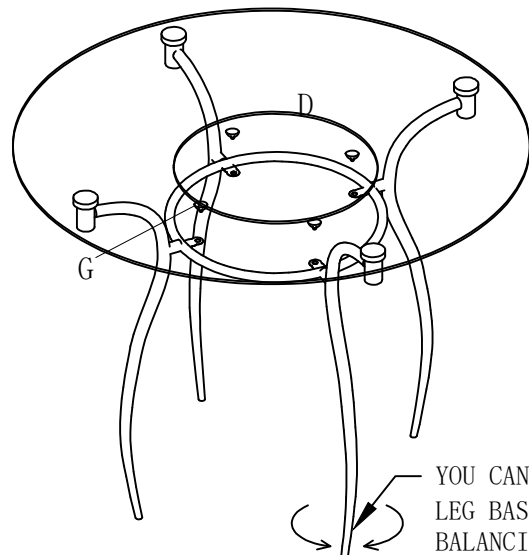

YOU CAN ADJUST THE LEG BASE (J) FOR BALANCING