

ASSEMBLY INSTRUCTION

Ottoman

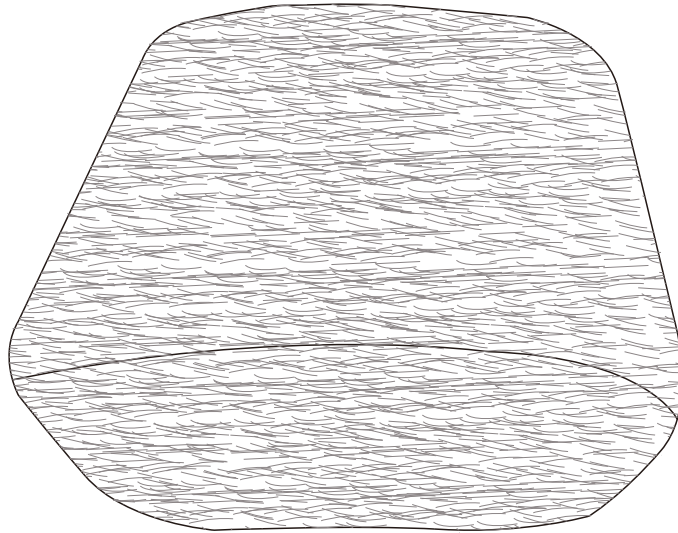

Thank you for choosing our product.

To ensure safe and satisfactory use of this product, please carefully read the below instructions beforehand.

1. Our cushions are vacuum packed for convenient shipping. Please allow 2-3 days for them to fully expand to their original shape and for any wrinkles to disappear.

2. In the event that a part is damaged or missing, no need to return the product, we will gladly help and ship your replacement parts free of charge.

PART LIST & HARDWARE

(BOX1)

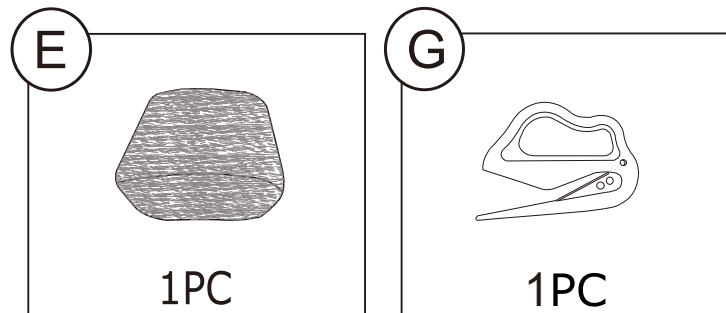

The cushion is packaged by vacuum compression. After cutting the package, it rebounds quickly within 4 hours. If the fabric has wrinkles, it will basically disappear after standing for 72 hours.

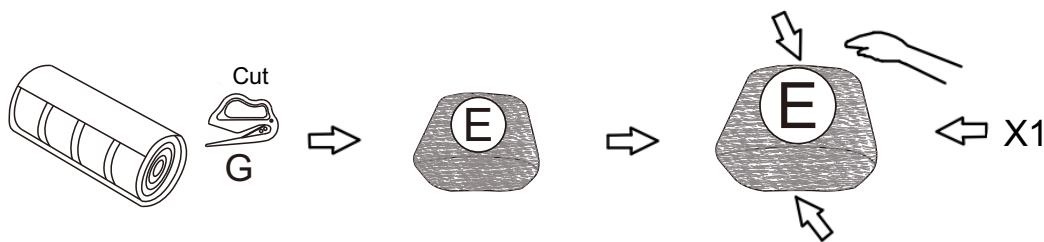

Completed.

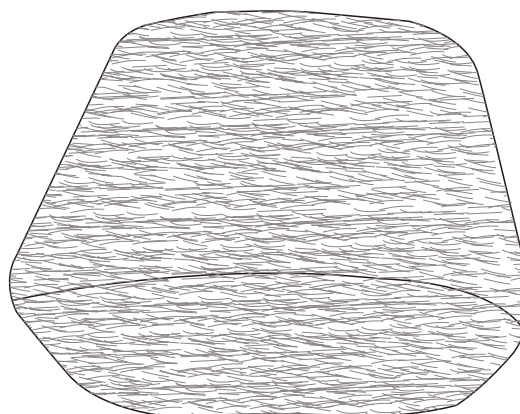

Daily maintenance

1. Avoid direct sunlight.
2. Keep sharp objects away from the surface of the sofa.
3. Clean with a soft-bristled brush or the soft brush head of a vacuum cleaner.

ASSEMBLY INSTRUCTION



This instruction booklet contains important safety information. please read and keep for future reference.

This sofa collection works as modular sofa function, started as 2-seater sofa with left and right section, you can buy more components such as armless middle seat and ottoman to make it as 3-seater sofa, 4-seater sofa, L shape sectional, U shape sectional or sofa set. Measure your living room size before you make a decision to buy more components to ensure all sofa section are well fit your living room area.

To ensure safe and satisfactory use of this product, please carefully read the below instructions beforehand.

1. This sofa ships in several boxes, we recommend unpacking and starting assembly when several boxes are received.

2. Our cushions are vacuum packed for convenient shipping. Please allow 2-3 days for them to fully expand to their original shape and for any wrinkles to disappear.

3. In the event that a part is damaged or missing, no need to return the product, we will gladly help and ship your replacement parts free of charge.

Below are some guidelines for you how you can do mix and match.

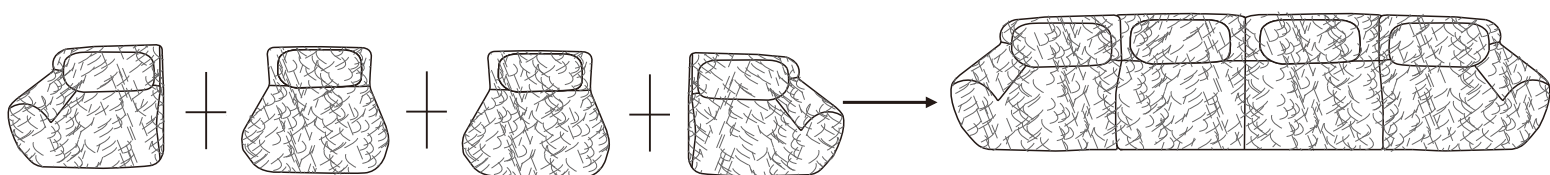
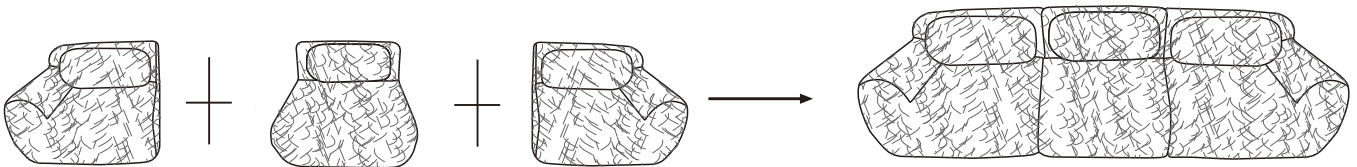

IF YOU BUY 2 SEATER SOFA
please follow below assembly instruction

Parts included (BOX1)

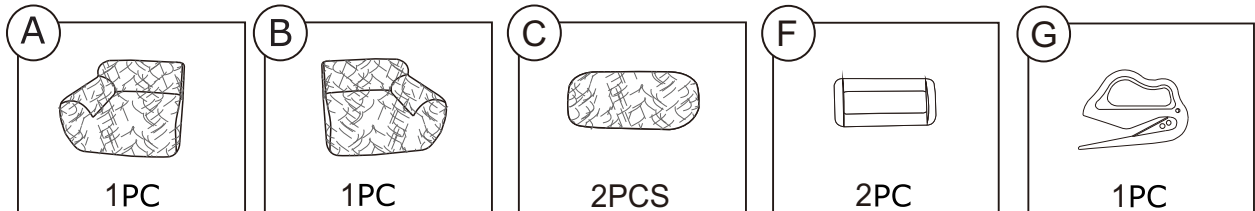

The cushion is packaged by vacuum compression. After cutting the package, it rebounds quickly within 4 hours. If the fabric has wrinkles, it will basically disappear after standing for 72 hours.

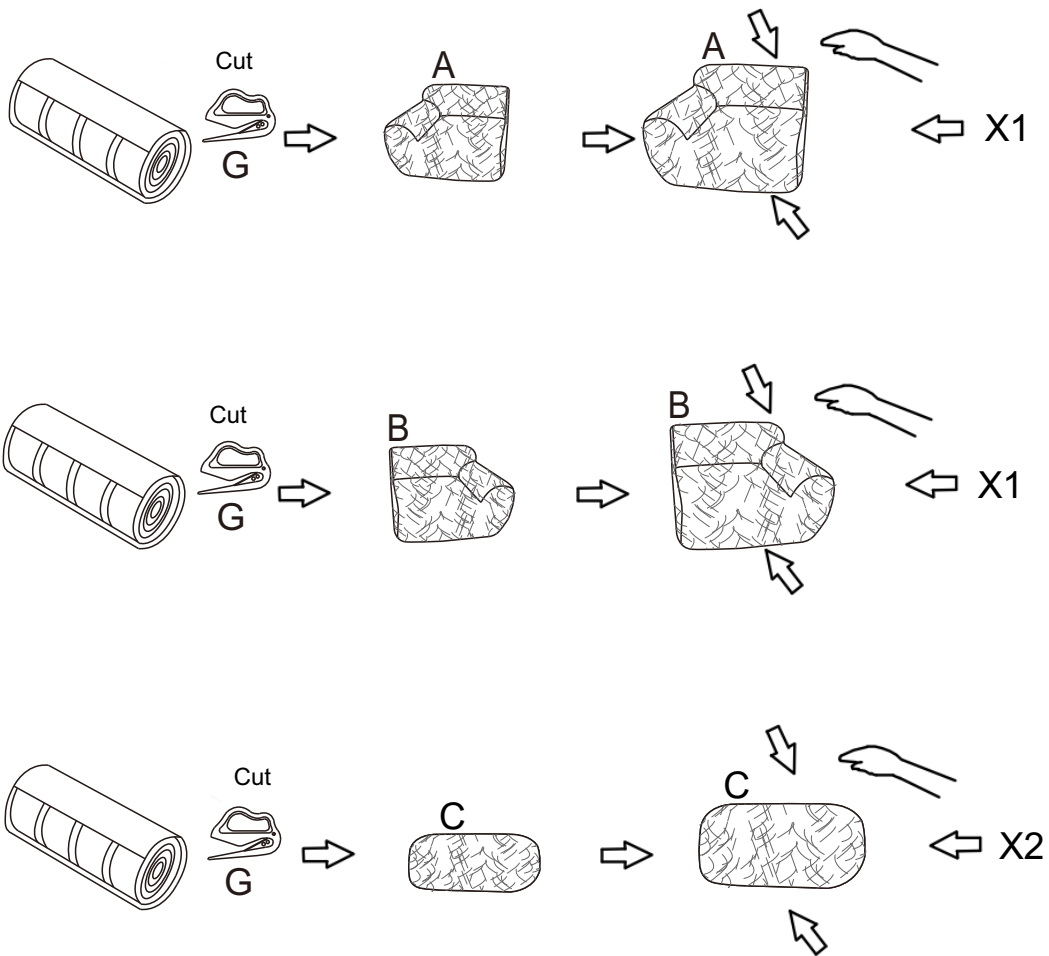

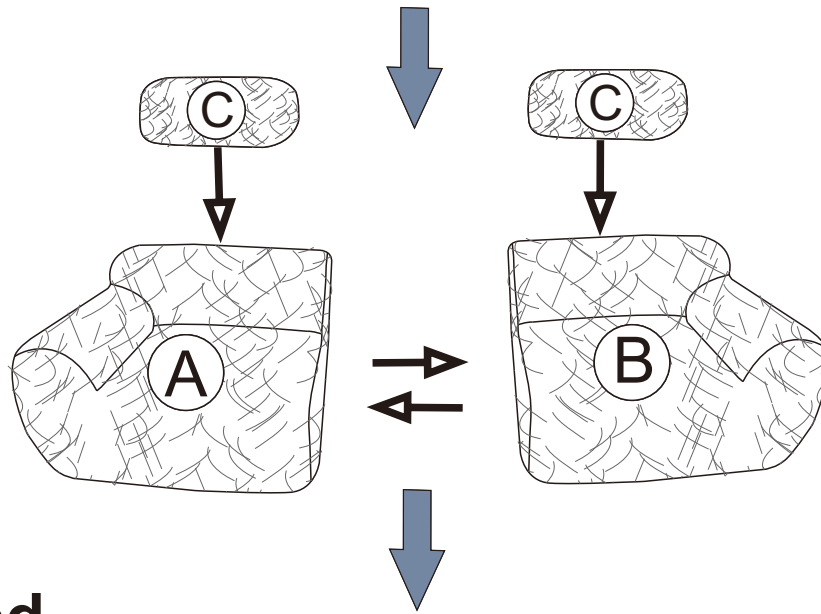
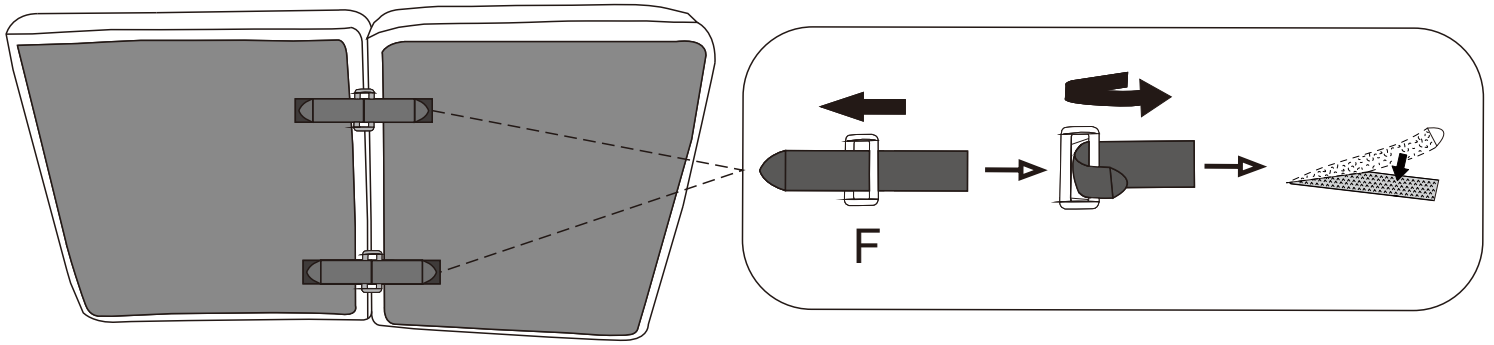

Completed.

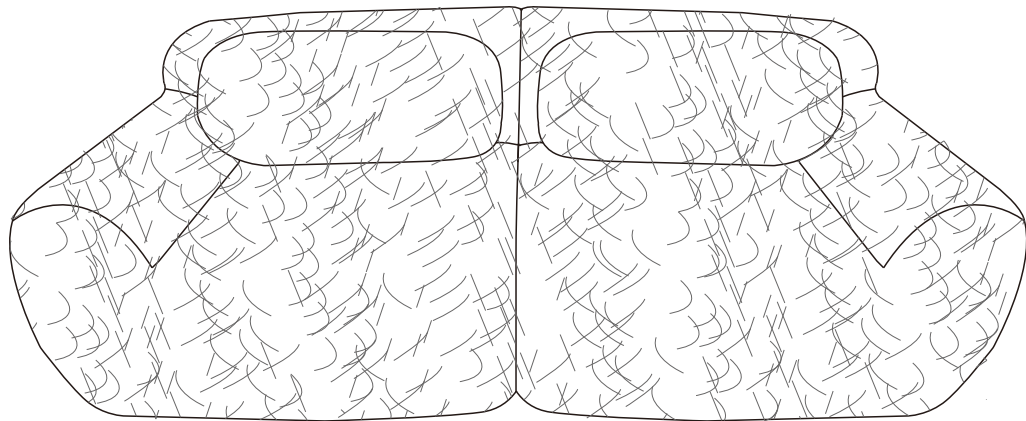

Daily maintenance

1. Avoid direct sunlight.
2. Keep sharp objects away from the surface of the sofa.
3. Clean with a soft-bristled brush or the soft brush head of a vacuum cleaner.

IF YOU BUY 3 SEATER SOFA
please follow below assembly instruction

Parts included (BOX1)

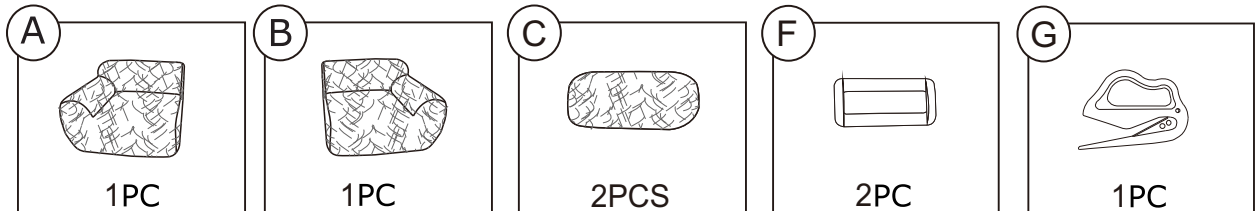

The cushion is packaged by vacuum compression. After cutting the package, it rebounds quickly within 4 hours. If the fabric has wrinkles, it will basically disappear after standing for 72 hours.

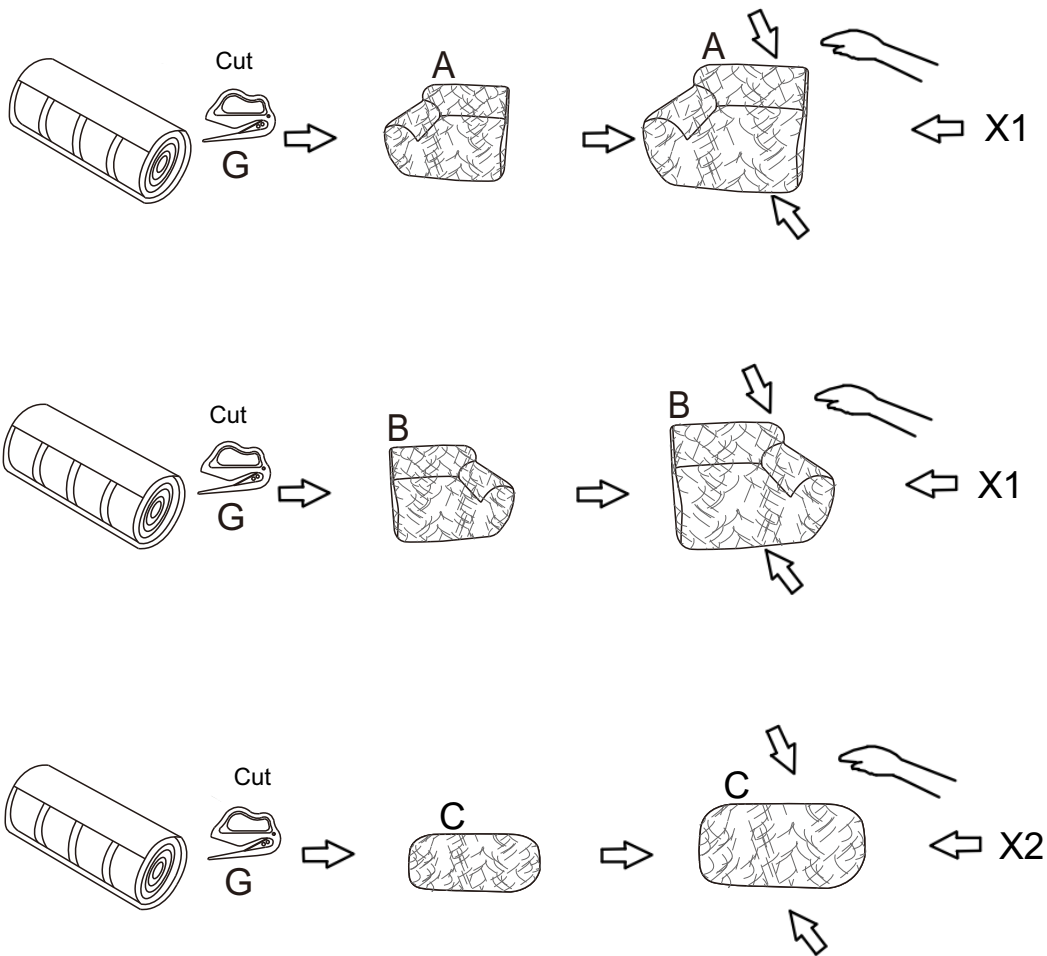

IF YOU BUY 3 SEATER SOFA
please follow below assembly instruction

Parts included

(BOX2)

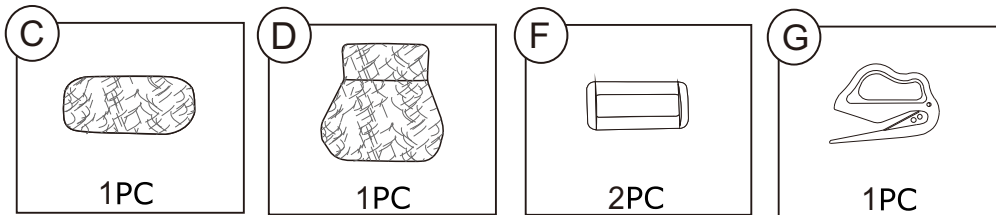

The cushion is packaged by vacuum compression. After cutting the package, it rebounds quickly within 4 hours. If the fabric has wrinkles, it will basically disappear after standing for 72 hours.

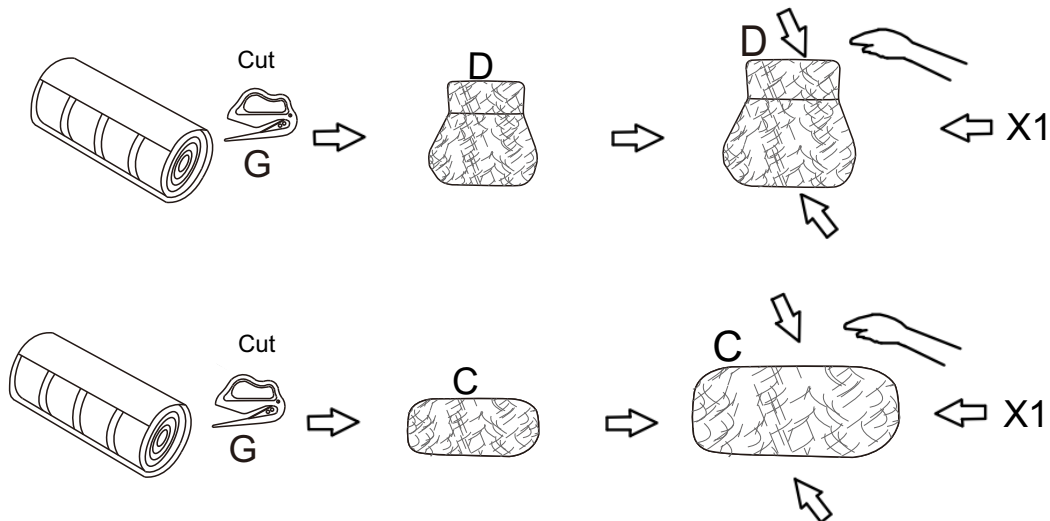

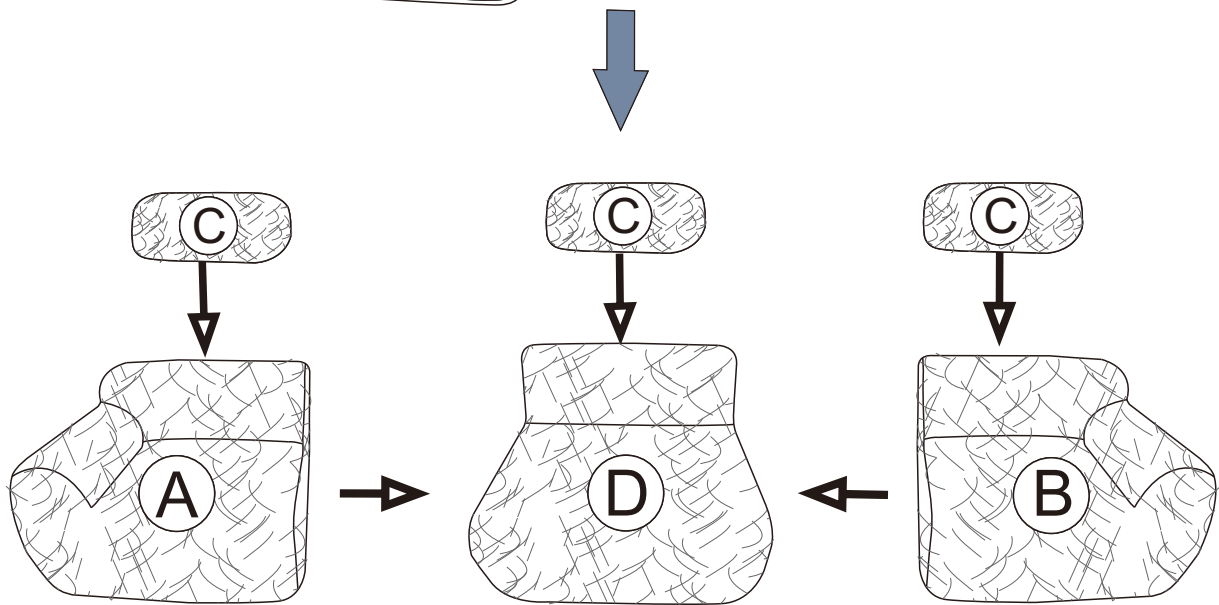
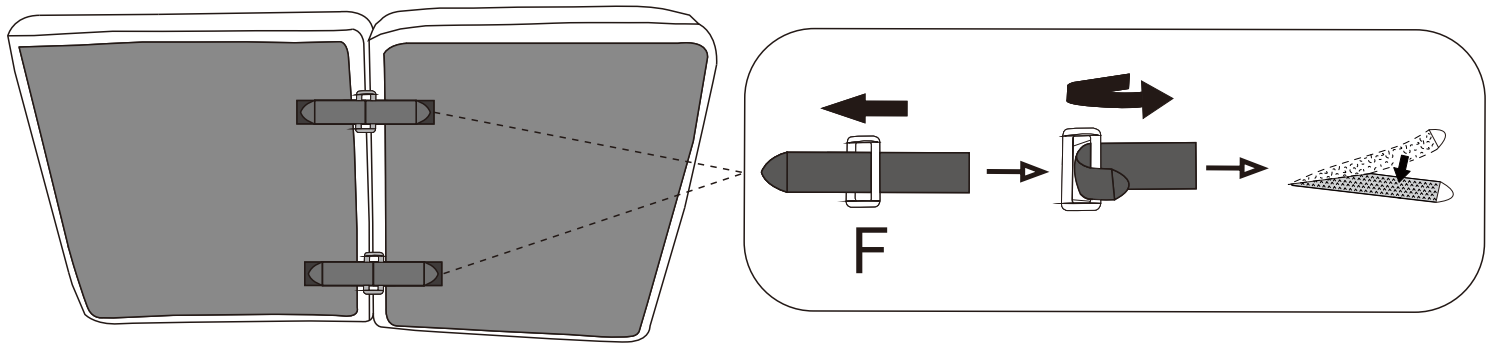

Completed.

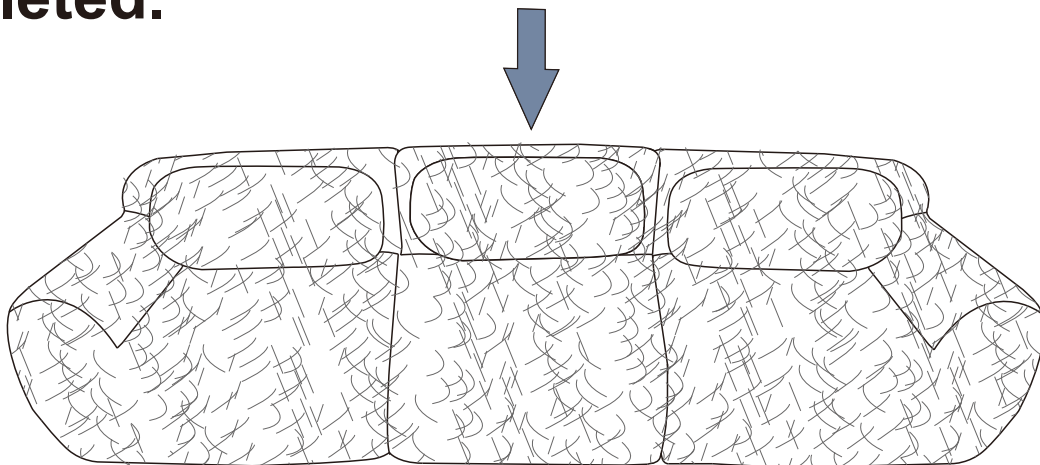

Daily maintenance

1. Avoid direct sunlight.
2. Keep sharp objects away from the surface of the sofa.
3. Clean with a soft-bristled brush or the soft brush head of a vacuum cleaner.

IF YOU BUY 4 SEATER SOFA
please follow below assembly instruction

Parts included (BOX1)

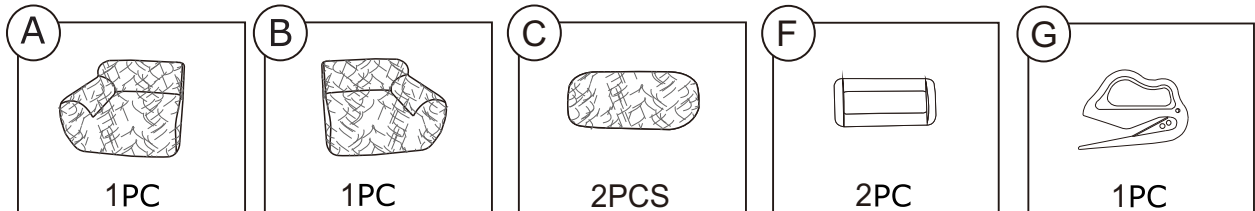

The cushion is packaged by vacuum compression. After cutting the package, it rebounds quickly within 4 hours. If the fabric has wrinkles, it will basically disappear after standing for 72 hours.

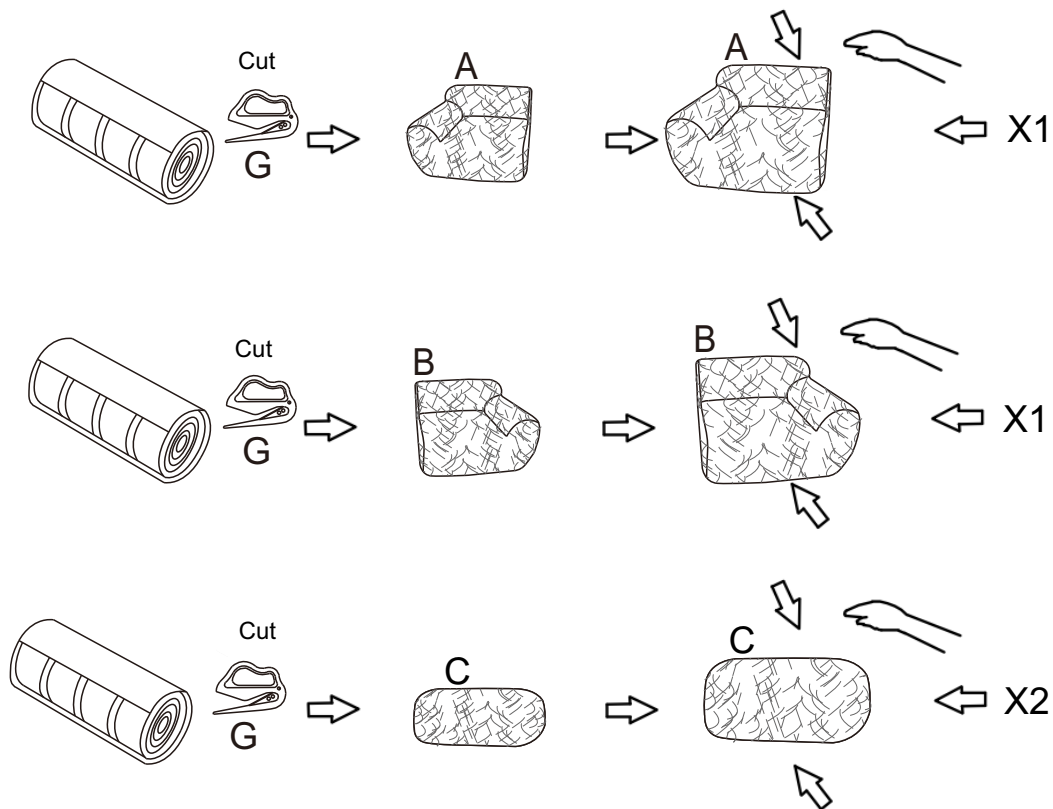

(BOX2)

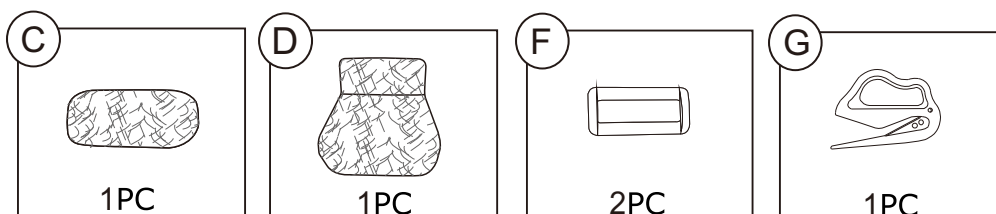

The cushion is packaged by vacuum compression. After cutting the package, it rebounds quickly within 4 hours. If the fabric has wrinkles, it will basically disappear after standing for 72 hours.

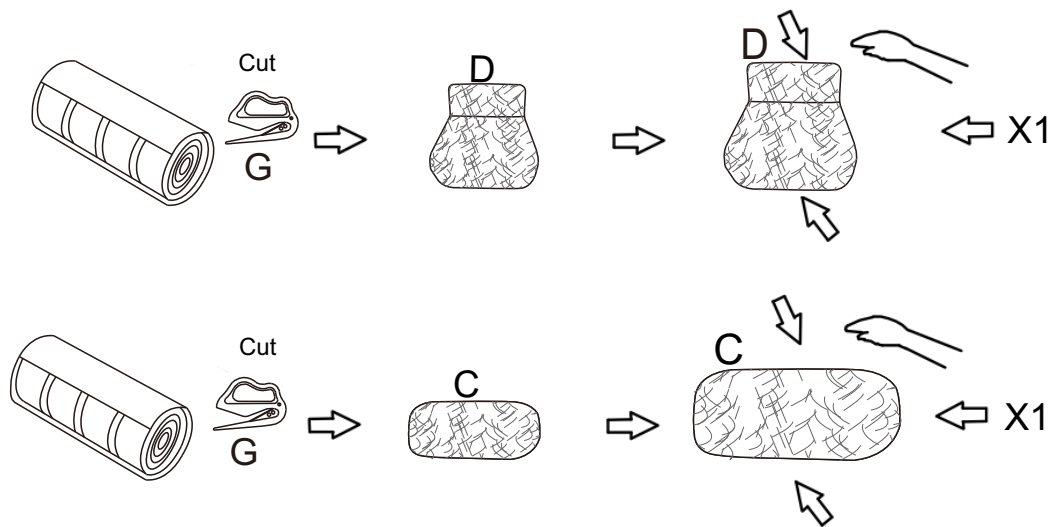

(BOX3)

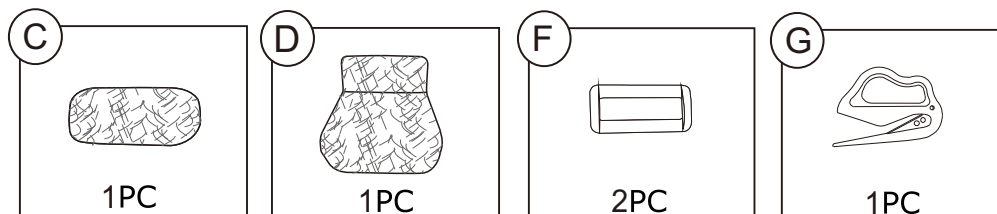

The cushion is packaged by vacuum compression. After cutting the package, it rebounds quickly within 4 hours. If the fabric has wrinkles, it will basically disappear after standing for 72 hours.

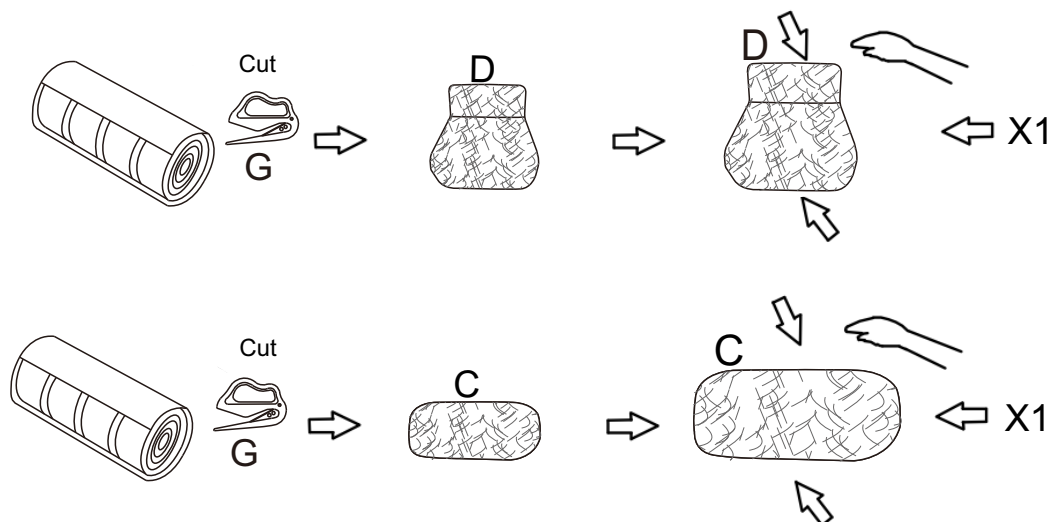

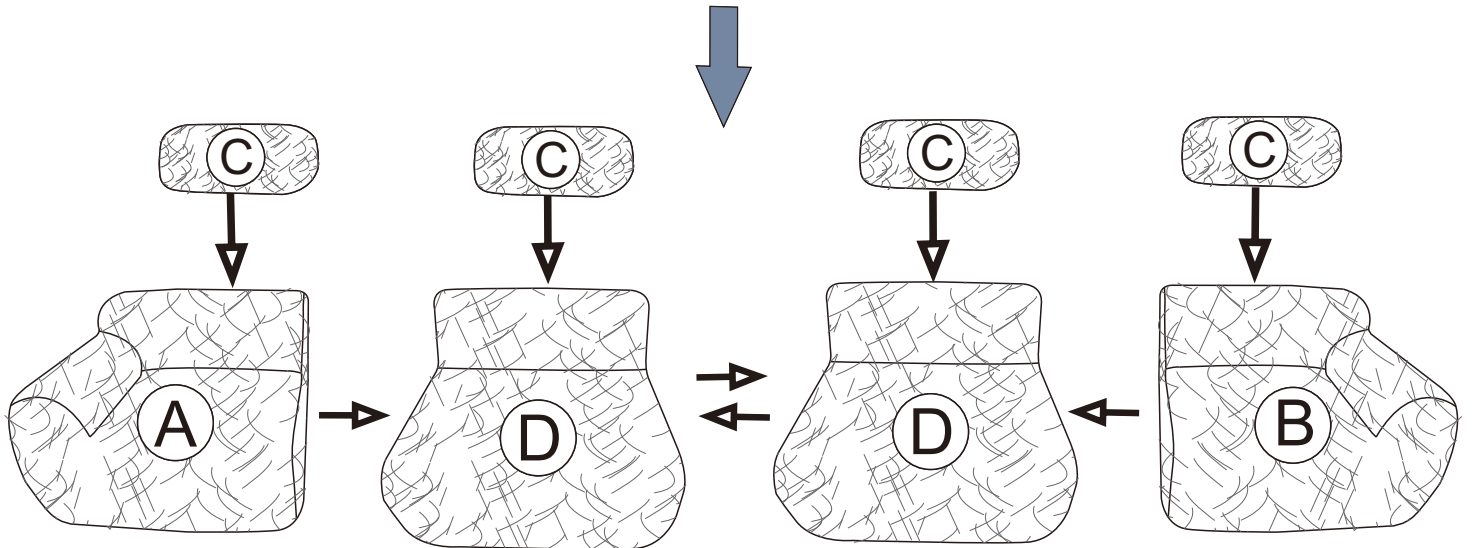
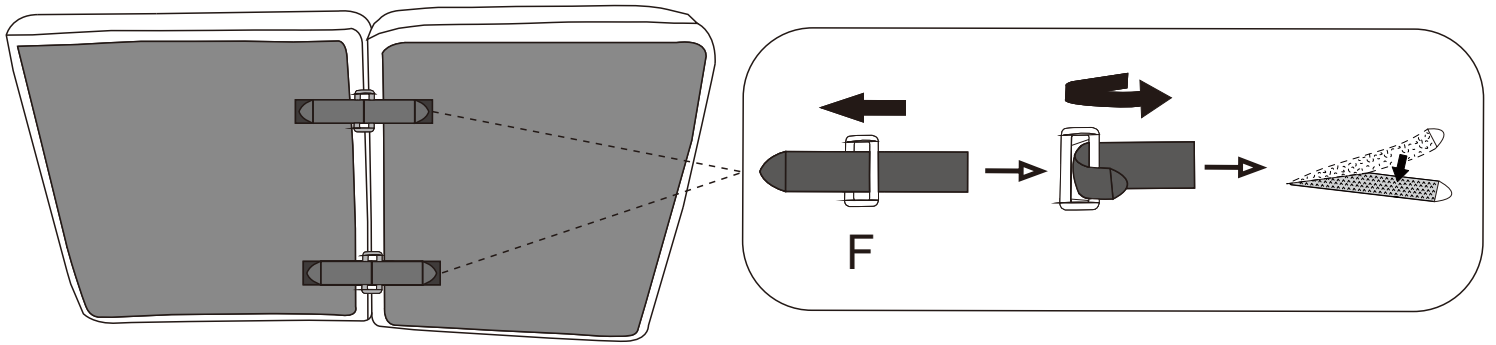

Completed.

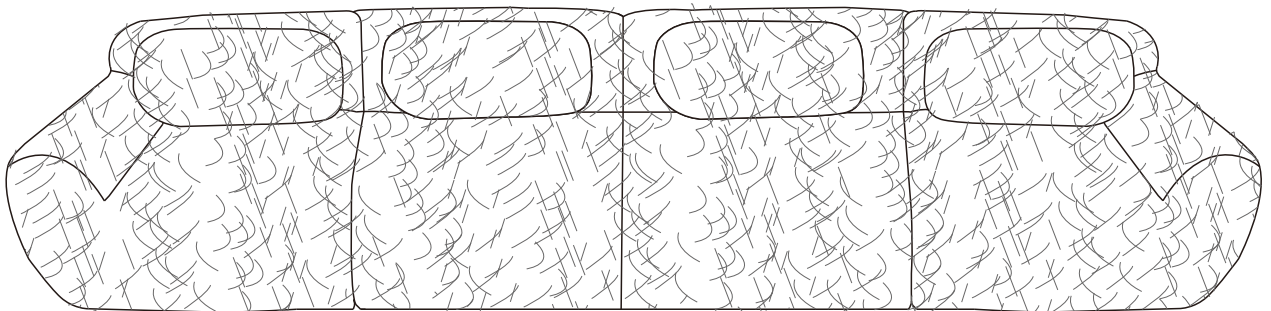

Daily maintenance

1. Avoid direct sunlight.
2. Keep sharp objects away from the surface of the sofa.
3. Clean with a soft-bristled brush or the soft brush head of a vacuum cleaner.