

# **ASSEMBLY INSTRUCTION**

## Friendly Reminder:

- 1.This sofa is packed in 2 boxes. Please assemble it After both boxes are received.
- 2.As the cushions are all vacuum compressed,there will be some wrinkles.  
Please give your cushions up to 72 hours to reach its original size and the wrinkles will basically disappear.
- 3.Please do not open the compressed packags until your sofa frame is completely assembled.

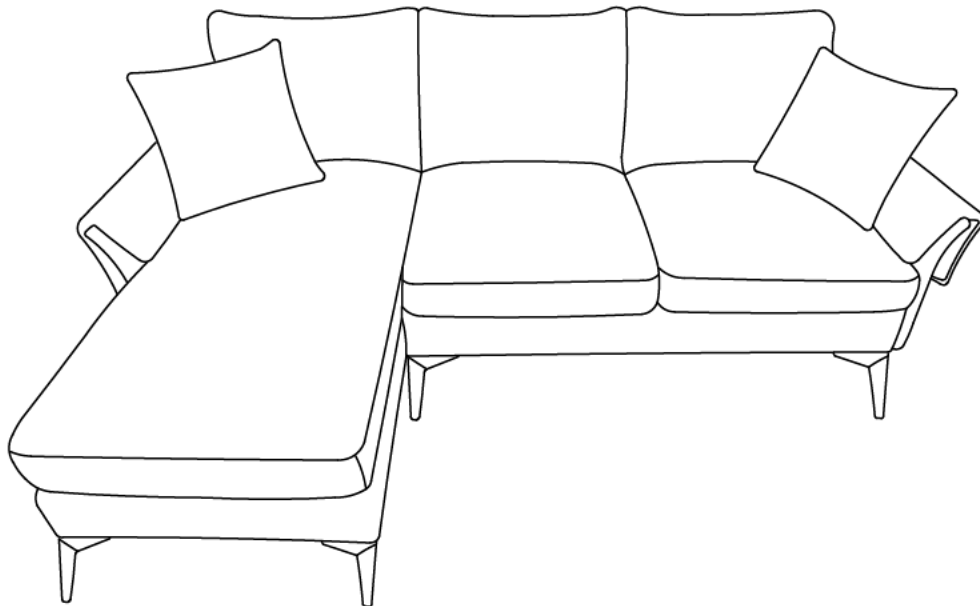







## Return & Warranty policy:



- We strive to offer the highest quality products,and we also try our best to satisfy each and every customer that orders from us with replacement parts or service as needed.
- If the item is damaged or defective, please take photos as evidence for replacements and refunds.
- Please do not return to store,contact the seller if yon have any troubles with this product.

# **ASSEMBLY INSTRUCTION**

## **HARDWARE**



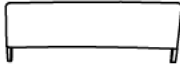
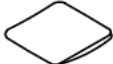

NO	DESCRIPTION	SKETCH	QTY
1	Washer		20
2	Screws 8X18		16
3	Screws 8X80		2
4	Screws 8X60		10
5	Screws 8X50		6
6	Butterfly Nut		2
7	Wrench		1

## **PARTS LIST**





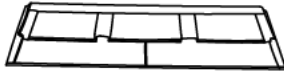

NO	DESCRIPTION	SKETCH	QTY
A	Love Seat Frame		1
E	Love Seat Backrest		1
G	Love Seat Cushion		2
H	Love Seat Cover		2

# ASSEMBLY INSTRUCTION

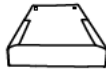
## PARTS LIST

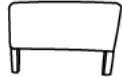
NO	DESCRIPTION	SKETCH	QTY
J	Chaise Cushion Cover		1
K	Back Cushion		2
M	Back cover		1
W	Arm cushion		2

## PARTS LIST

NO	DESCRIPTION	SKETCH	QTY
B	Chaise Frame		1
C	Armrest (Left)		1
D	Armrest (Right )		1
F	Chaise Backrest		1
I	Chaise Cushion		1
K	Back Cushion		1
L	Throw Pillow		2
N	Leg		8

## DIAGRAM 1

Tack the Love Seat Backrest(Parts E)Love Seat Cover(Parts H)Chaise Cushion Cover(Parts J)Back Cushion(Parts K)Back cover(Parts M)Arm cushion(Parts W)out of the Love Seat Frame(Parts A).

Tack the Armrest(Parts C and Parts D)Chaise Backrest(Parts F)Back Cushion (Parts K) Throw Pillow (Parts L)Leg(Parts N)out of the chaise Frame(Parts B).

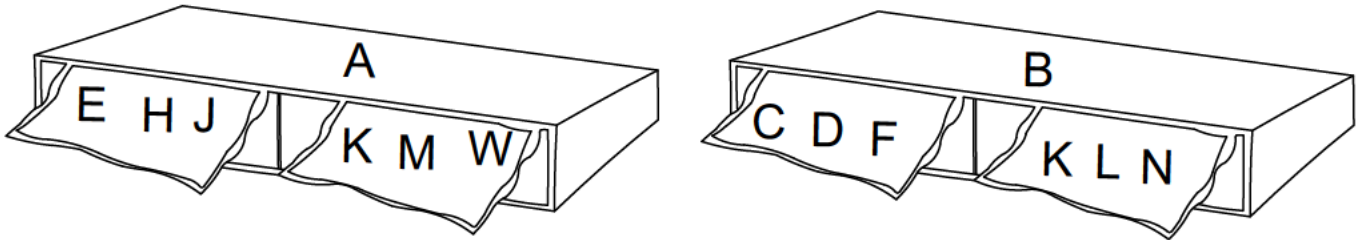

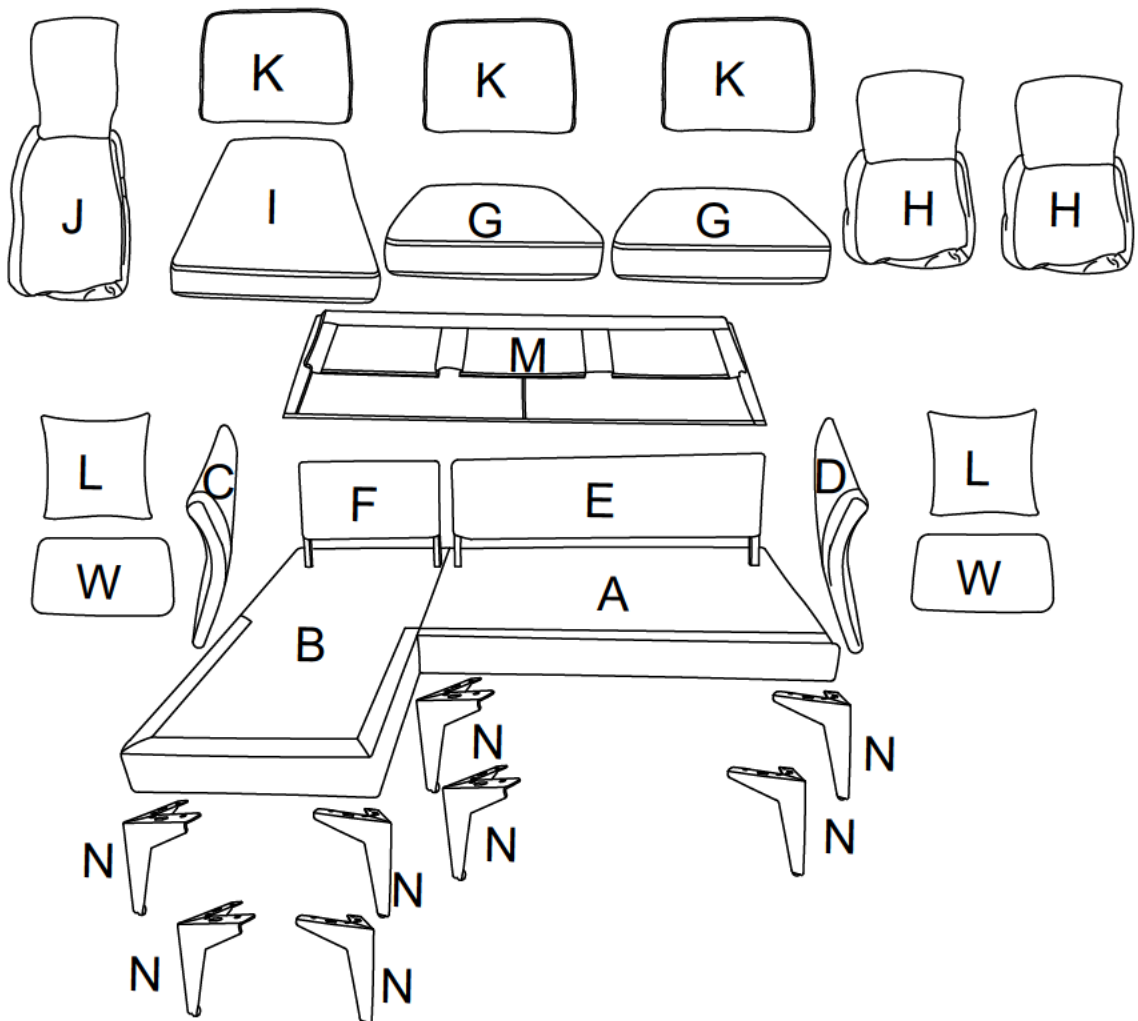

## DIAGRAM 2

All parts and hardware.



### DIAGRAM 3

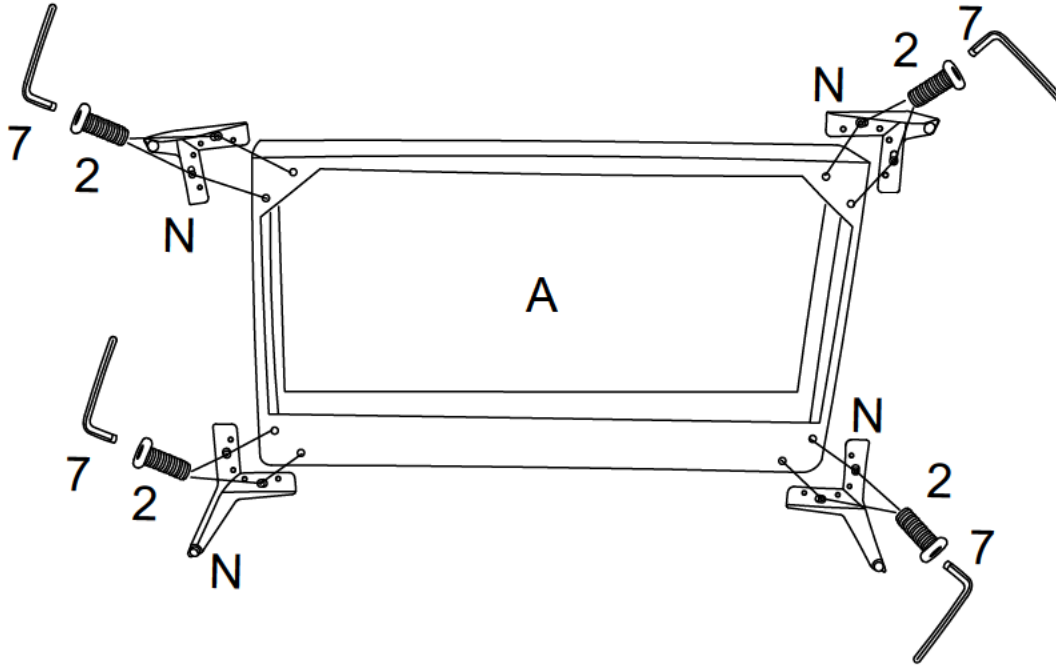

Tighten 4 legs (Parts N) by screws(Hardware 2) using the wrench(Hardware 7).

2	 M8X18	8PCS
N		4PCS



### DIAGRAM 4

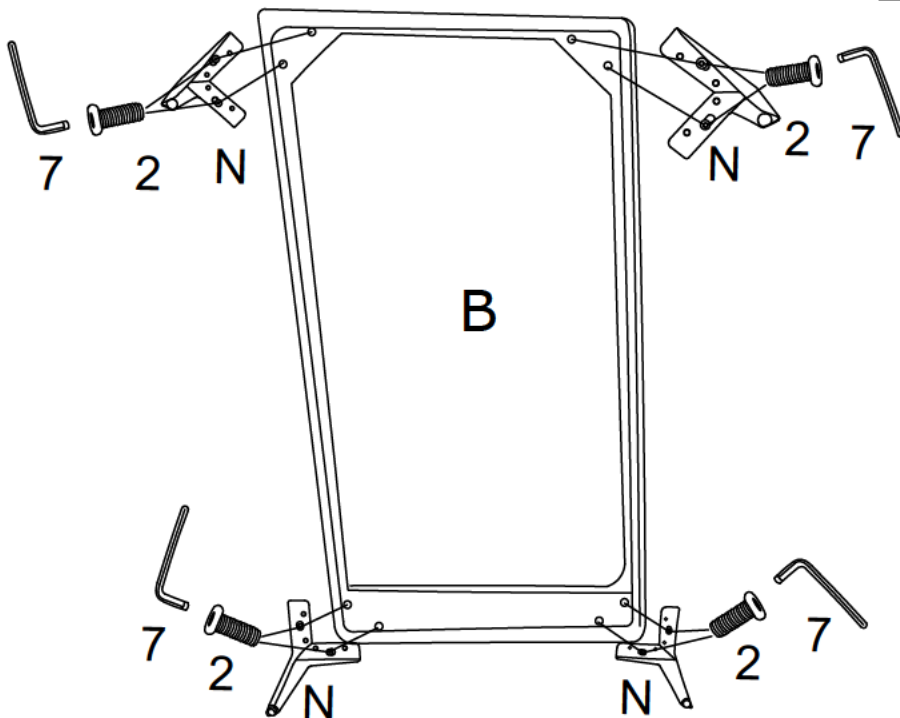

Tighten 4 legs (Parts N) by screws(Hardware 2) using the wrench(Hardware 7).

2	 M8X18	8PCS
N		4PCS



### DIAGRAM 5

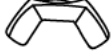

Connect the love seat sofa with the Chaise sofa tighten the screws(Hardware 3) with the butterfly nuts(Hardware 6)by wrench(Hardware7).

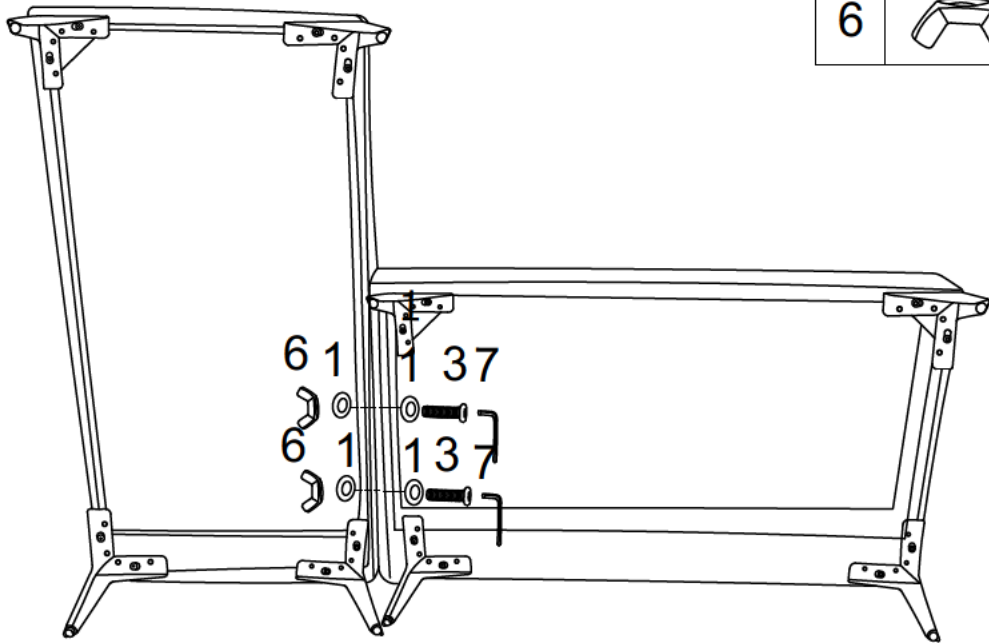
1		4PCS
3	 M8X80	2PCS
6		2PCS

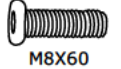

### DIAGRAM 6

Connect the armrest (Parts C)(Parts D)with washer(Hardware 1) screws(Hardware 4)(Hardware 5)by wrench (Hardware 7).

1		8PCS
4	 M8X60	2PCS
5	 M8X50	6PCS

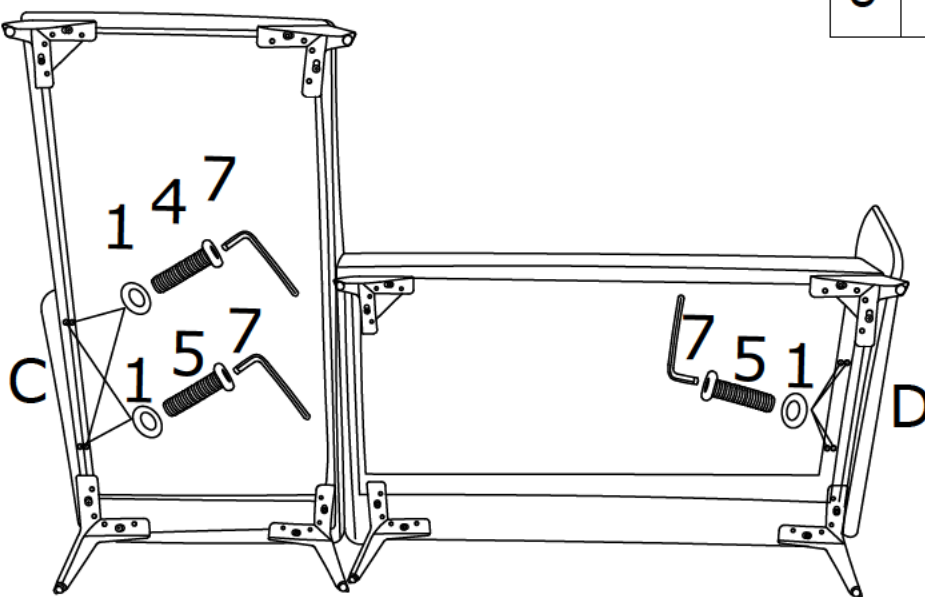

### DIAGRAM 7

Put Arm cushion (PartsW) ON Armrest (PartsC and PartsD) connect with Velcro.

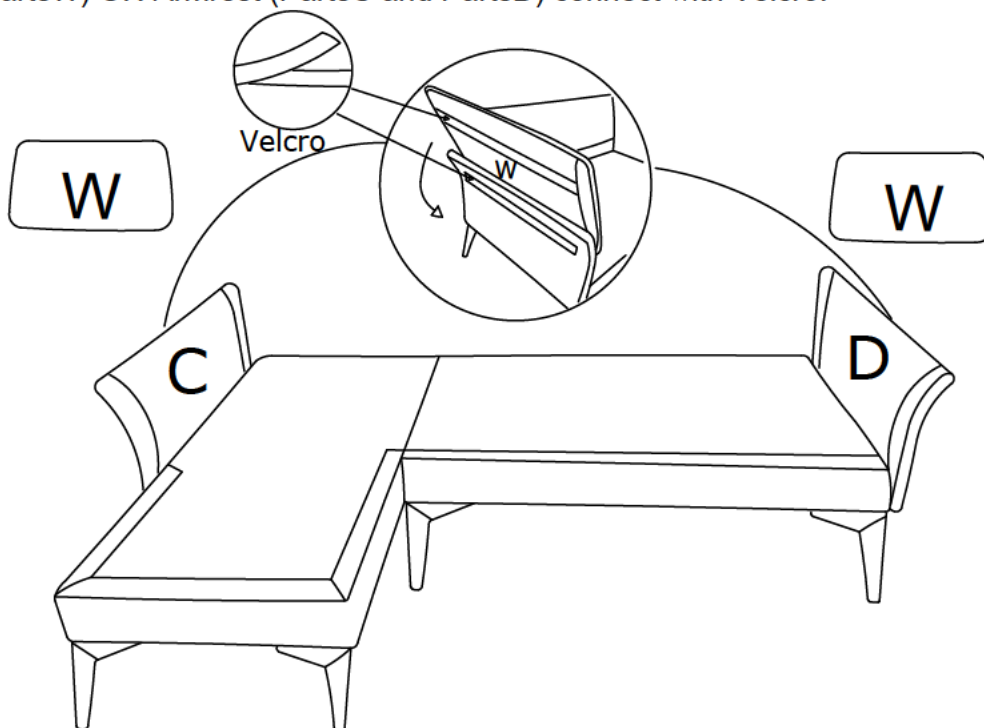

### DIAGRAM 8

Connect the Love Seat Backrest (PartsE) and Chaise Backrest (PartsF) tighten by 4 Screws(Hardware 4).

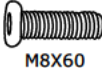

Please install the top screws first and then install the next screws.  
Don't tighten any screws before you ensure all the screws are put in the holes.

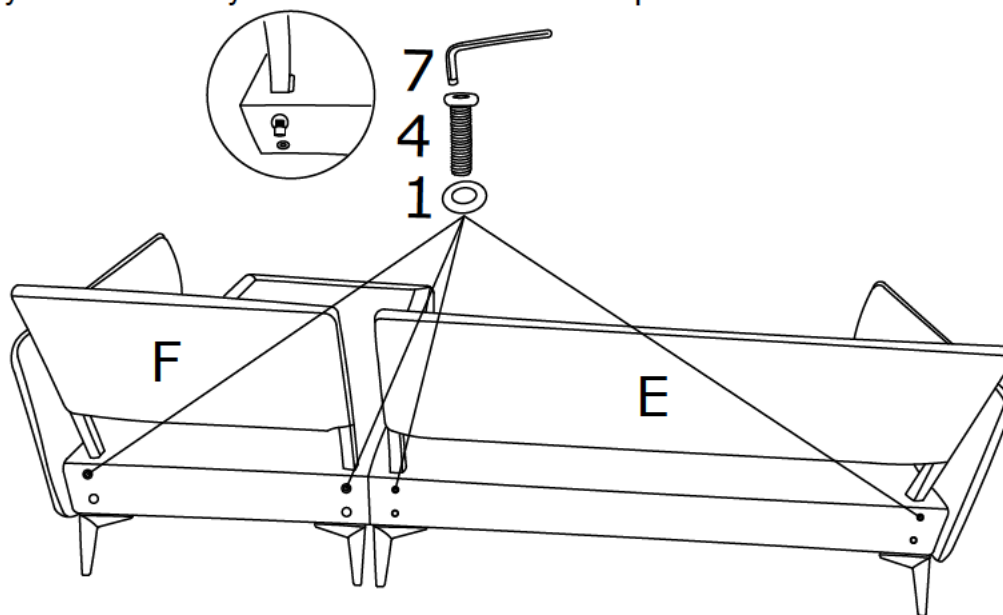
1		4PCS
4	 M8X60	4PCS



### DIAGRAM 9

Connect the Love Seat Backrest (Parts E) and Chaise Backrest (Parts F) tighten by 4 Screws(Hardware 4).

1		4PCS
4	 M8X60	4PCS

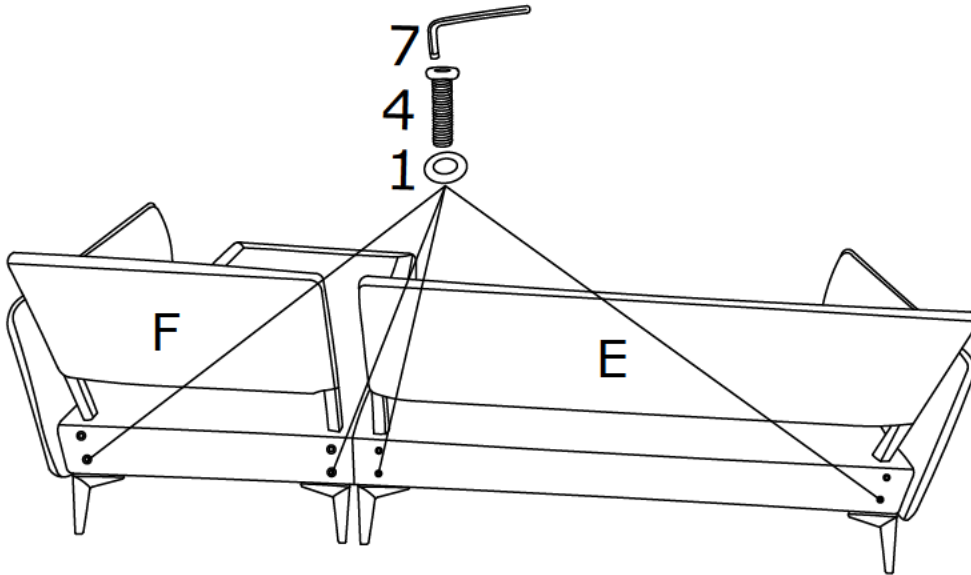

### DIAGRAM 10

Place the back cover (Parts M) over the backrest (Parts E and Parts F) .

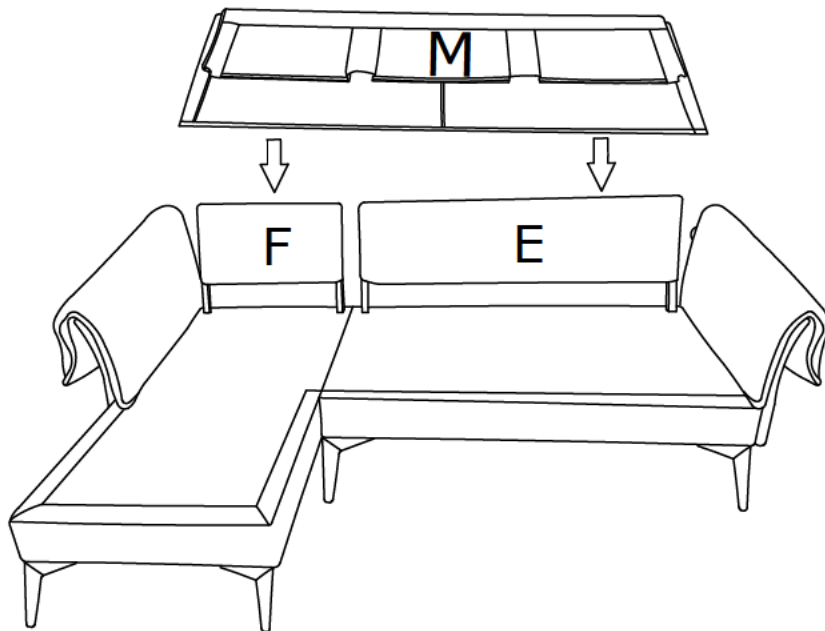

### DIAGRAM 11

Remove the plastic bags of Love Seat Cushion(Parts G) and Chaise Cushion (Parts I).  
Please align the chain first and then pinch the zipper gently and close it smoothly.

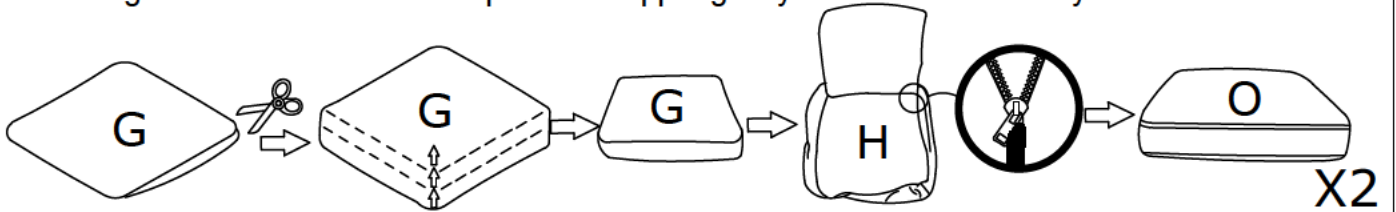

Stuffing Love Seat Cushion(Parts G) into Love Seat Cover(Parts H) and zip it up.

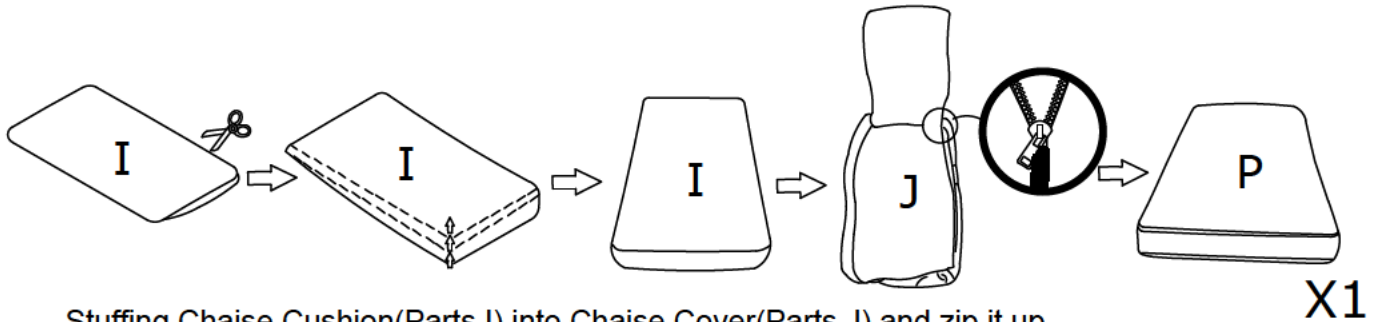

Stuffing Chaise Cushion(Parts I) into Chaise Cover(Parts J) and zip it up.

### DIAGRAM 12

Remove the plastic bags of Back Cushion(Parts K) and Throw Pillow (Parts L).

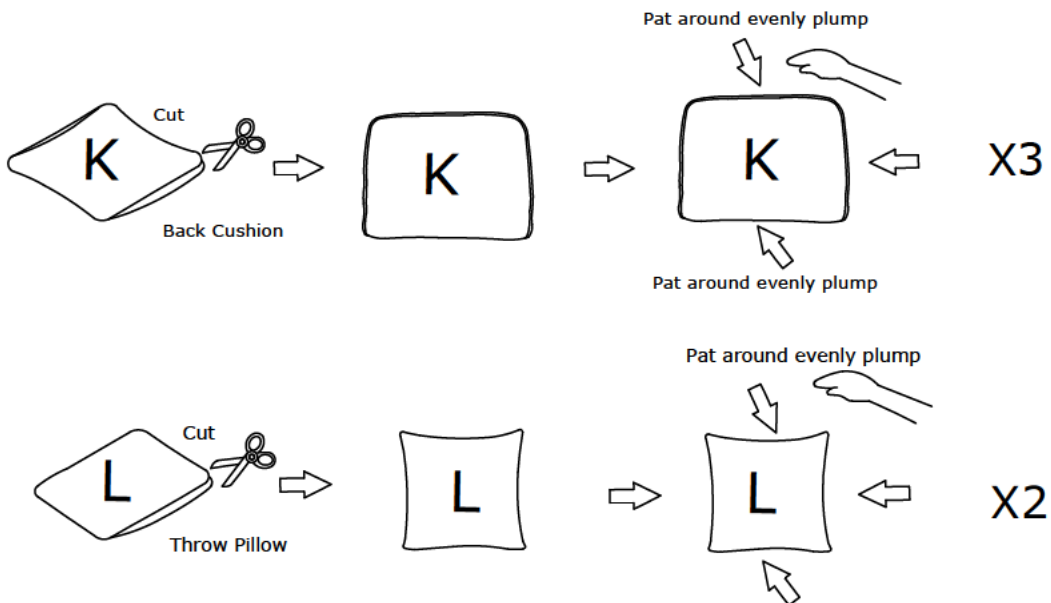

**TIPS:**

1. Please do not open the compressed packages until your sofa frame is completely assembled.
2. Compressed back cushions and pillows need to be fully fulfilled within 72 hours for your perfect use.
3. Please keep children away from plastic bags or any small pieces of stuff.

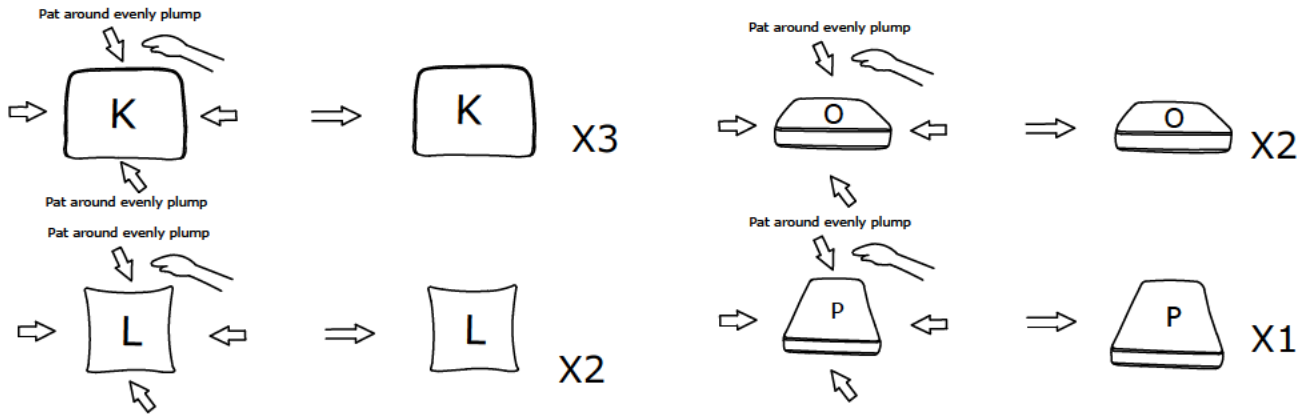

**DIAGRAM 13**

Put the love seat cushions (Parts O) and Chaise Cushion (Parts P), the back cushions (Parts K) and the Throw Pillow (Parts L) on the sofa.  
Recheck all the bolts before you sit on the sofa.

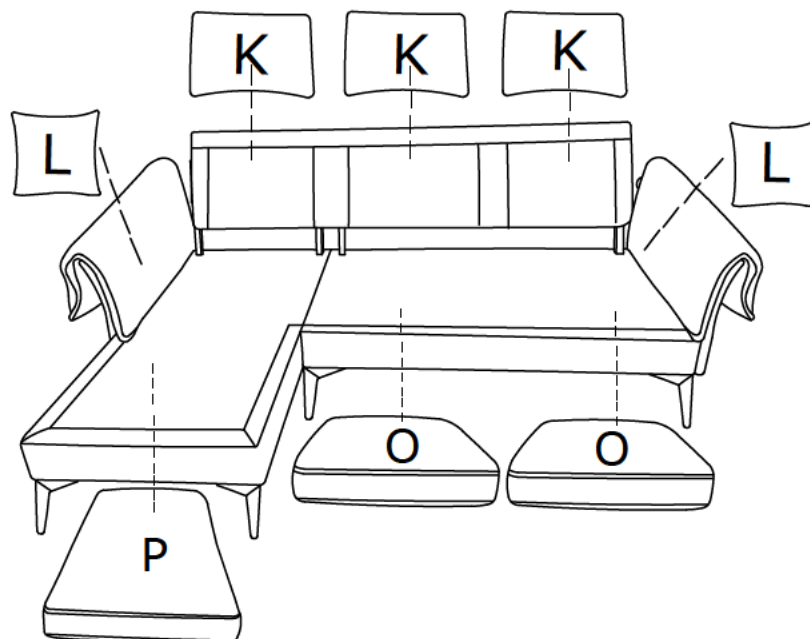

**TIPS:**

1. Please do not open the compressed packages until your sofa frame is completely assembled.
2. Compressed back cushions and pillows need to be fully fulfilled within 72 hours for your perfect use.
3. Please keep children away from plastic bags or any small pieces of stuff.

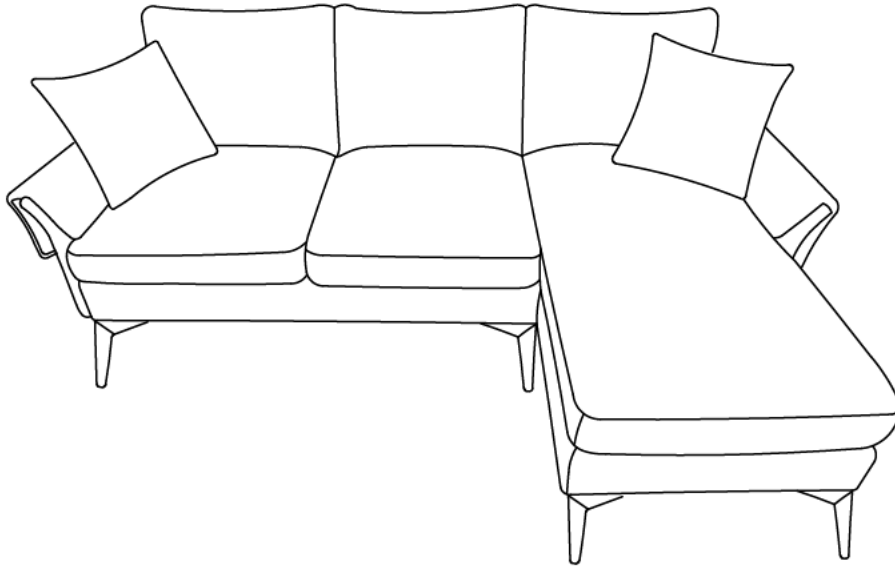

OR

