

ASSEMBLY INSTRUCTION

CHAISE

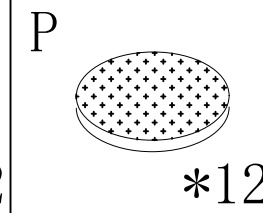

STEP 1:

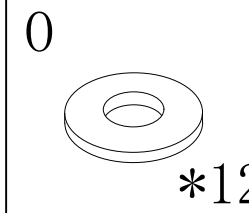
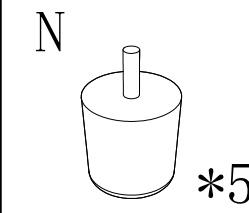
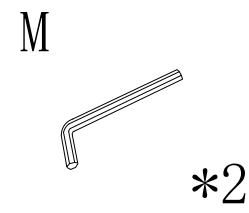
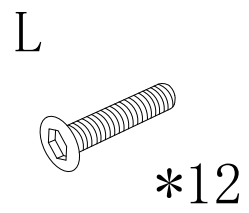
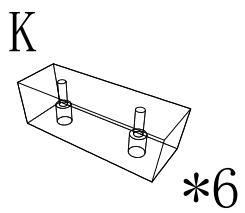
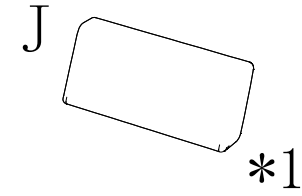
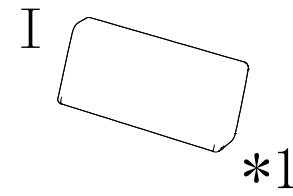
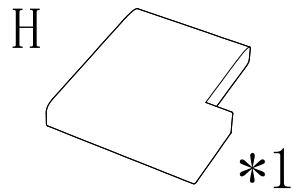
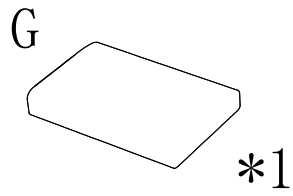
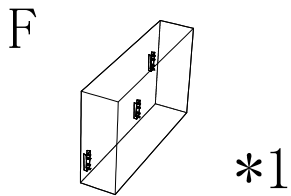
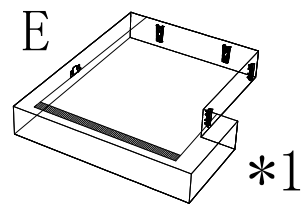
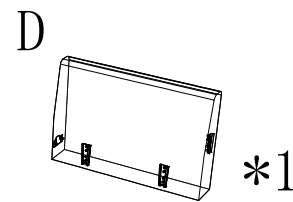
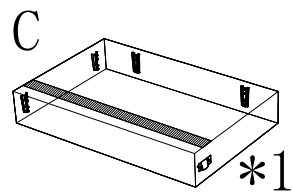
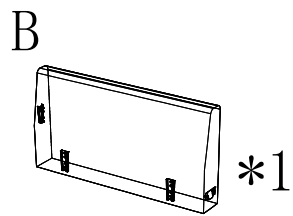
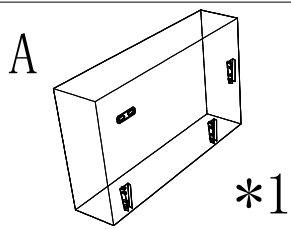
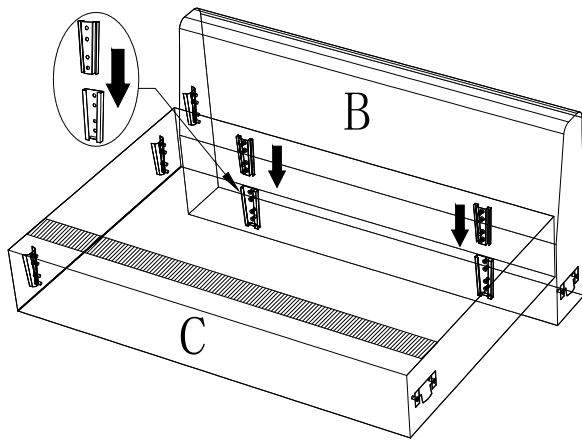

STEP 2:

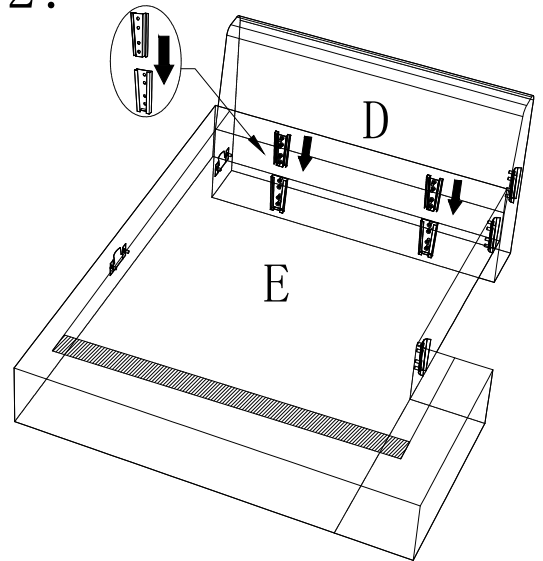



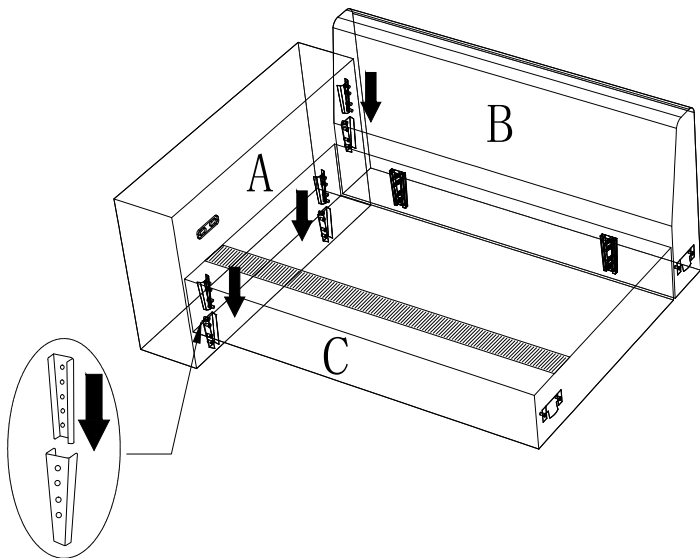

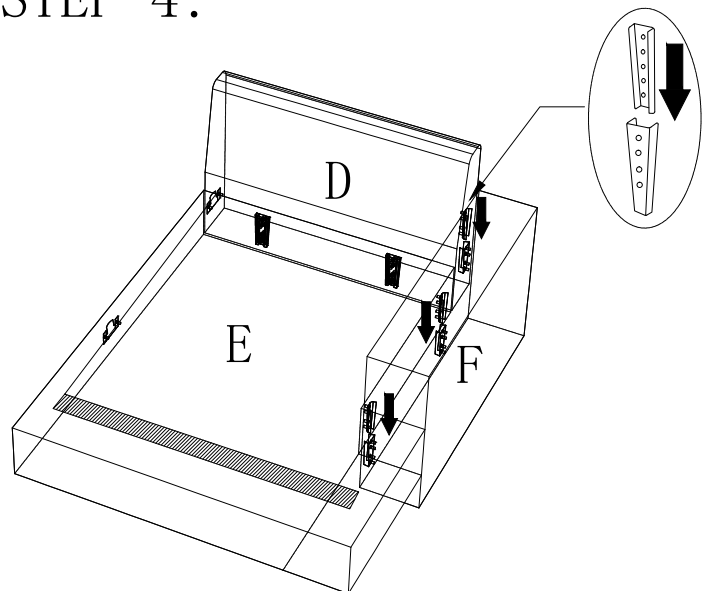

STEP 3:



STEP 4:







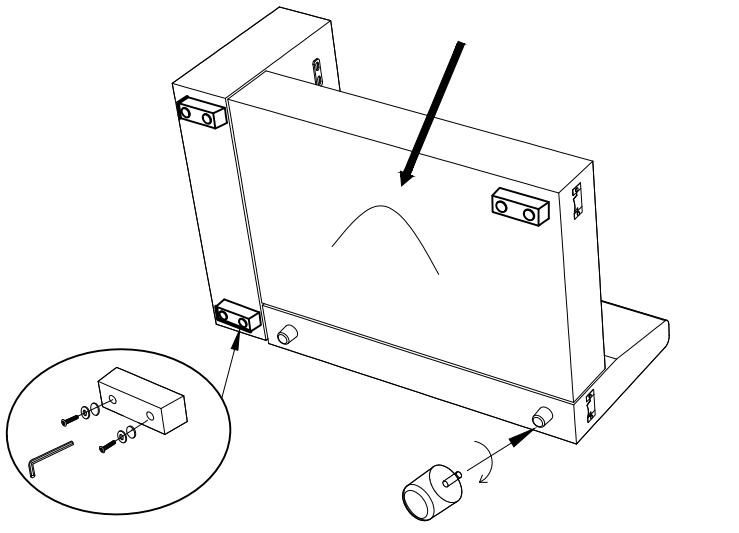

STEP 5:

| | | | | | | | |
|---|--|---|--|---|---|---|---|
| K |  *3 | N |  *2 | O |  *6 | P |  *6 |
| L |  *6 | I |  *1 | | | | |
| M |  *1 | | | | | | |



STEP 6:

| | | | | | | | |
|---|--|---|--|---|---|---|---|
| K |  *3 | N |  *3 | O |  *6 | P |  *6 |
| L |  *6 | | | | | | |
| M |  *1 | | | | | | |

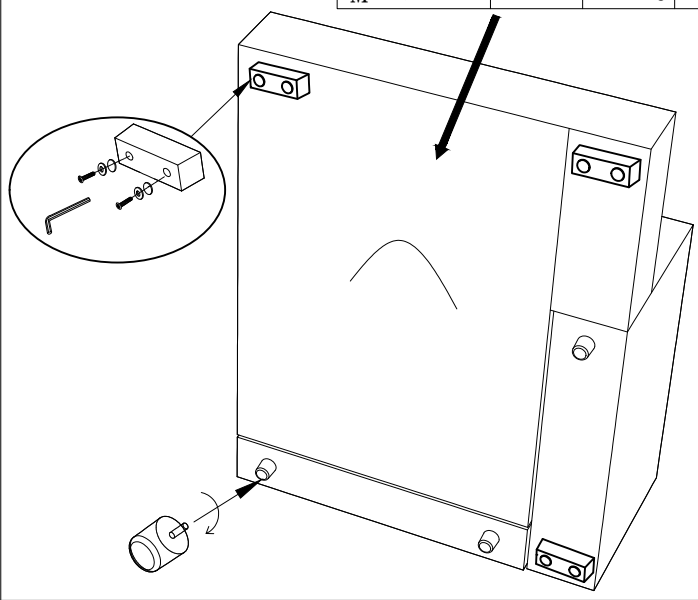

STEP 7:

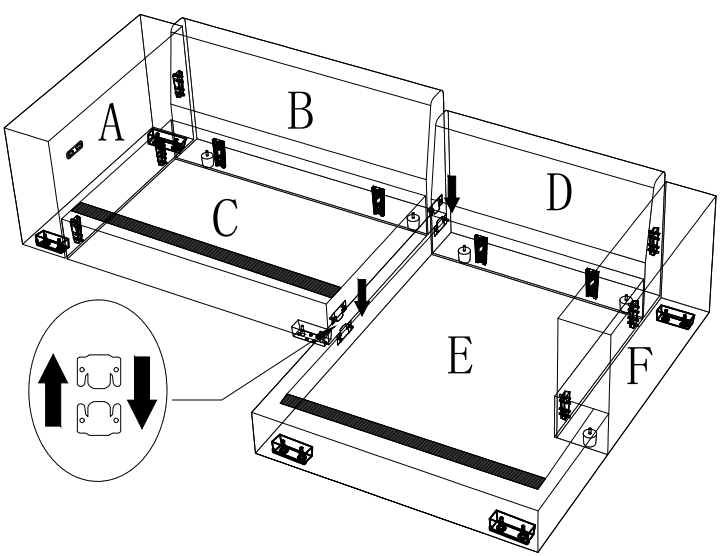

STEP 8:

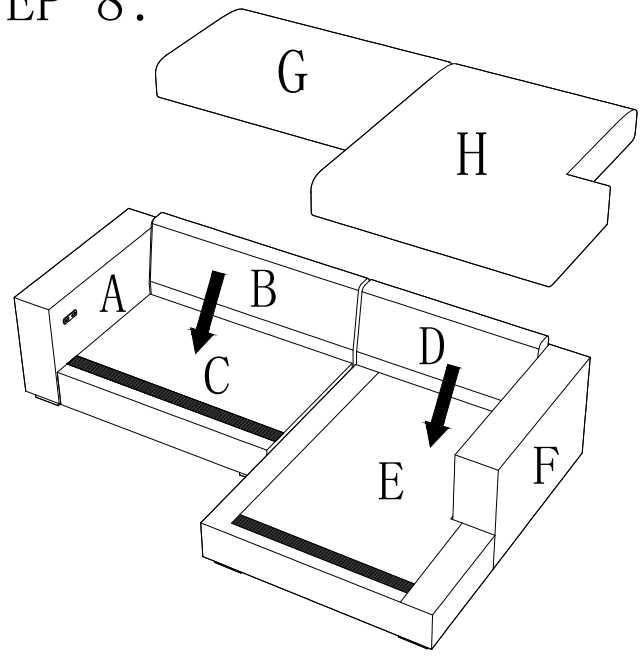

STEP 9:

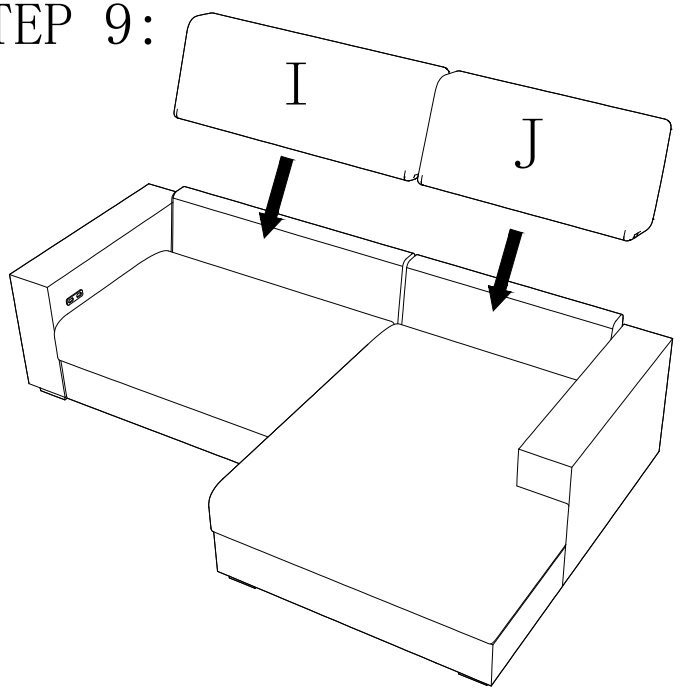

STEP 10:

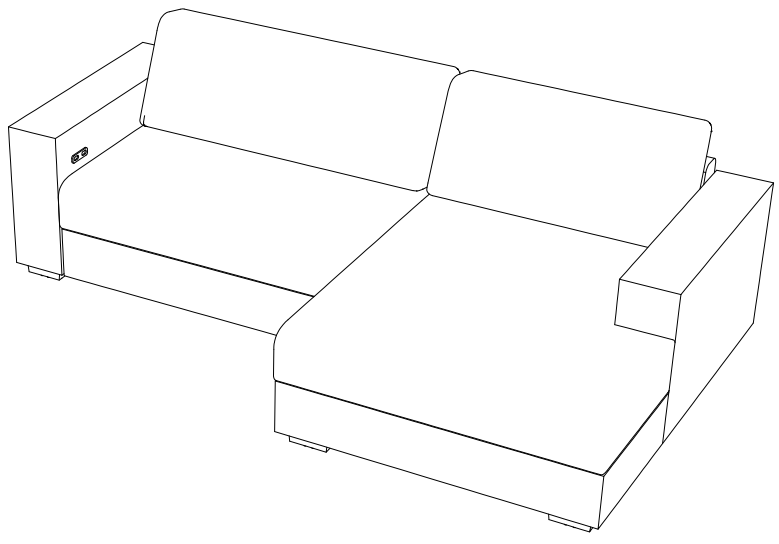

ASSEMBLY INSTRUCTION

OTTOMAN

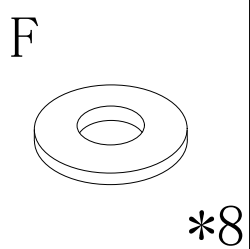
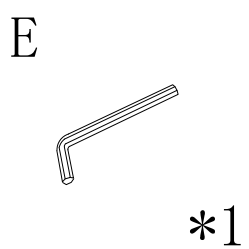
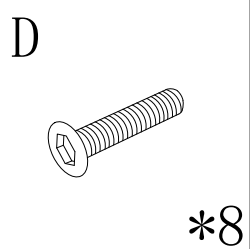
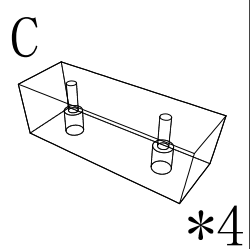
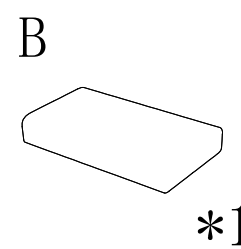
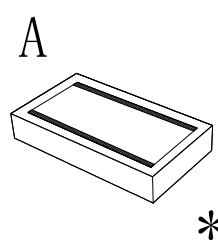

STEP 1:

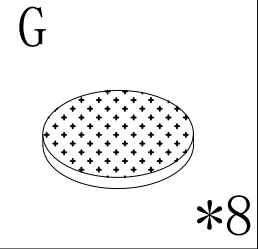
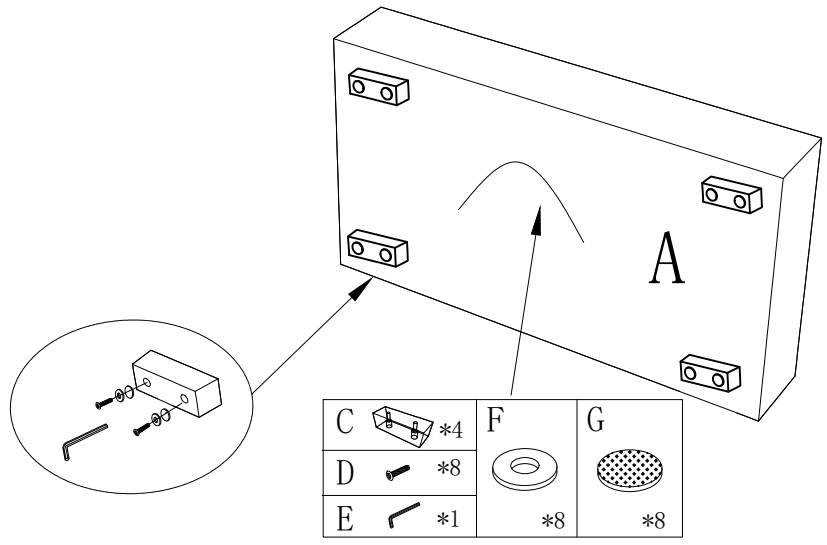

STEP 2:

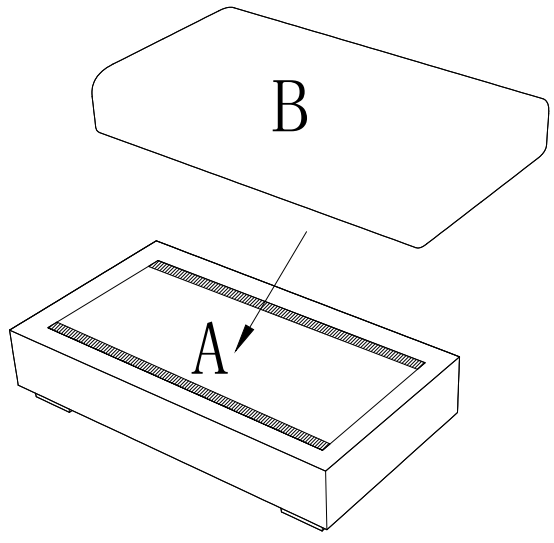

STEP 3:

