

Owner Manual

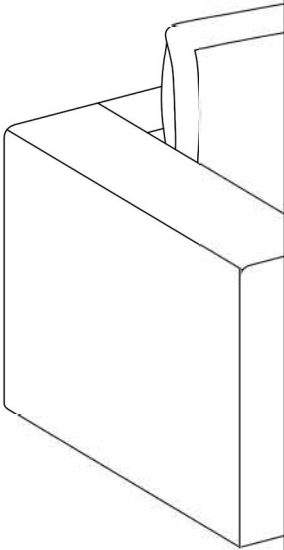

WARRANTY

We strive to offer high quality product and we also try our best to satisfy each customer that order from us, no matter on products or services as needed. Each customer receives a record of their order, such as the order number or item receipt. For any items that are out of warranty period, you may still be able to purchase the replacement parts from our company if they are available.



MAINTENANCE AND WARNING

Please read the manual thoroughly
before you start installing.

Please keep the product away from
sharp object.

Packaging and small parts may have
chocking hazard, please keep them away
from children and pets.

Please clean the product according to each
clean code, check the product description
for more information.

Please keep the product away from
fire.

If you have any other questions, please
contact us, we will be glad to help you out.

If the product is placed under direct
sunlight, the pattern or color might fade
away overtime.

Check the product periodically to make
sure everything is secured and tightened.

Always use proper tools for installation.

Do not jump on the product.

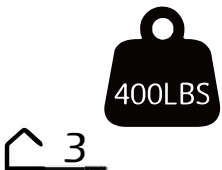

One people



Around 5 min

PRODUCT DESCRIPTION

Premium Chenille Fabric – Soft, breathable, and visually refined, the chenille upholstery adds both luxury and durability

Advanced Cushion Design – Dense foam sponge paired with a pocket spring core ensures lasting comfort and balanced support.

Full Foam-Compressed Structure – Provides exceptional elasticity and retains shape over time for consistent performance.

Ergonomic Build – Pillow-top backrest and perfectly measured armrest height create natural, body-supportive comfort.

Modular Flexibility – Equipped with anti-slip pads and Velcro connectors for easy attachment to other sections, enabling endless layout possibilities.

EXPLODED VIEW



The product's left and right are determined by sitting posture

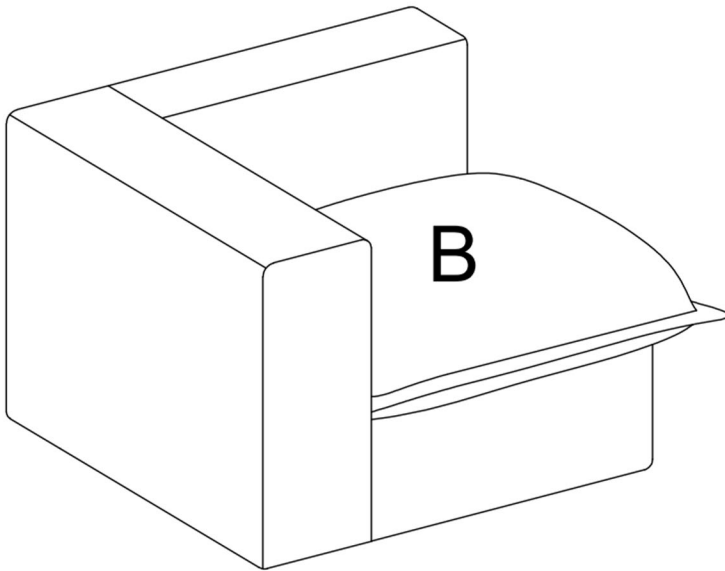
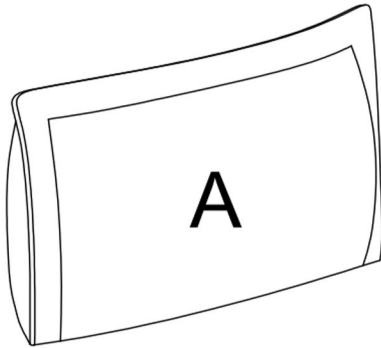

PARTS

A*1

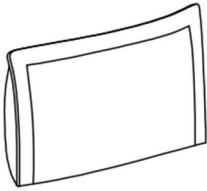

Back cushion

B*1

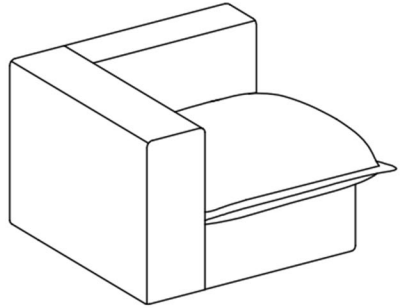

Seat cushion

I*1



The connecting stripes

HARDWARE

TOOL LIST

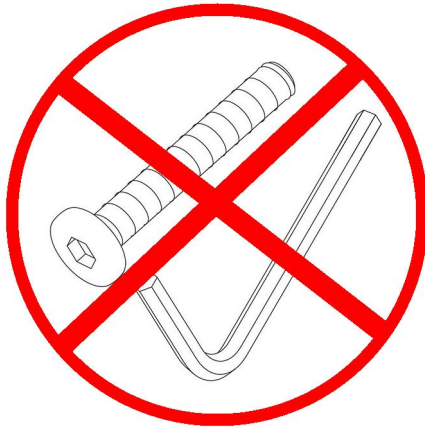

Please be aware:

This chair does not come with extra accessories fittings (such as bolts, washers etc.)

step 1

Take out the roll of compressed product from the box. Cut open the compression bag along the paper strip on the roll bag. Remove the sofa and let them rest to recover their shape. Full recovery may take up to **72** hours, but you can gently slap the sofa to speed up the process.

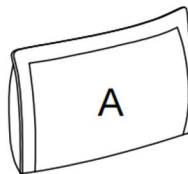
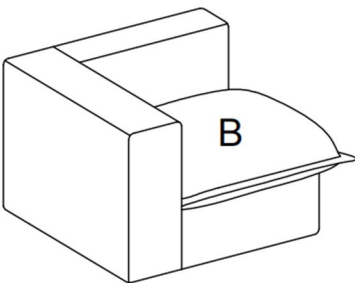
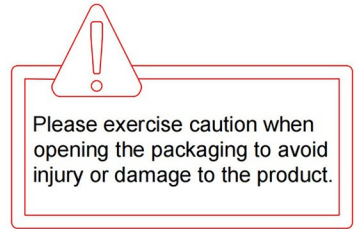
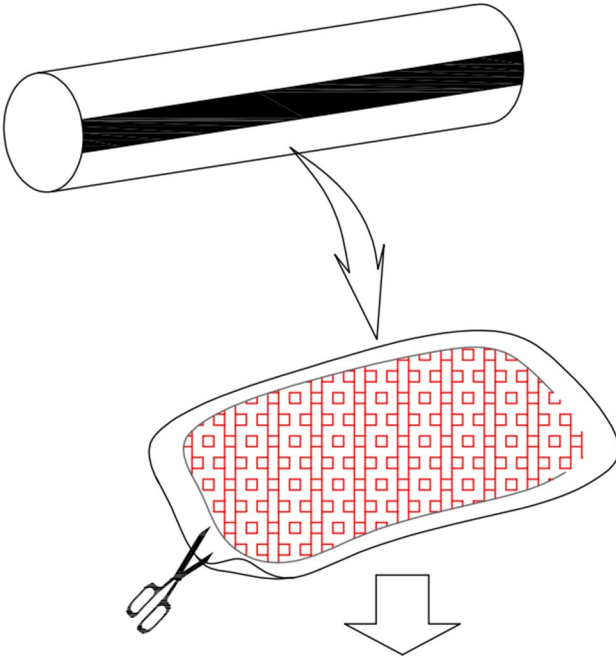

step 2

Place the back cushion (A) on it.

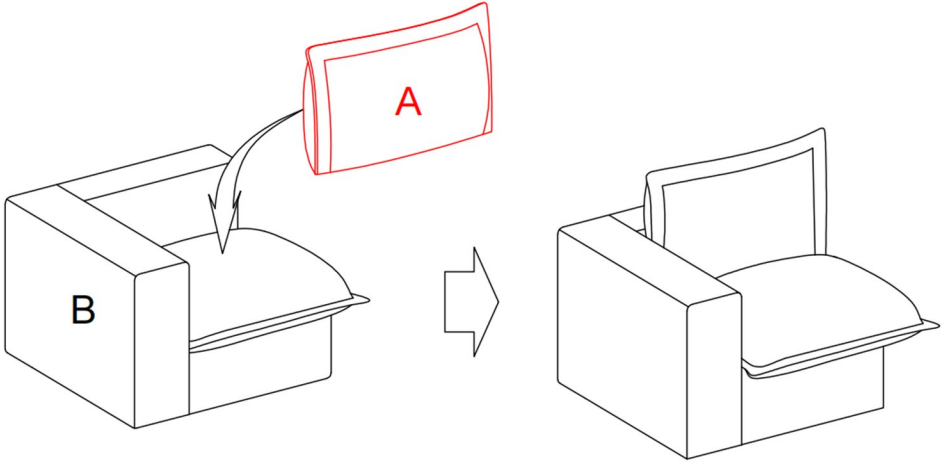

NOTICE

The product requires at least **72 HOURS** to return to its original shape after being removed from the air compression bag.

The restore period is **IMPORTANT** for the product please try not to use it while restoring.

step 3

Each carton includes a piece of felt fabric. Attach it to the Velcro strips at the bottom of the sofa to connect the individual modules together. If you are using a single sofa module and do not need to combine multiple pieces, this felt fabric is not required.

